

User Manual



TDS3000B Series Digital Phosphor Oscilloscopes 071-0957-04

This document supports firmware version 3.00
and above.

www.tektronix.com

Copyright © Tektronix. All rights reserved. Licensed software products are owned by Tektronix or its subsidiaries or suppliers, and are protected by national copyright laws and international treaty provisions.

Tektronix products are covered by U.S. and foreign patents, issued and pending. Information in this publication supercedes that in all previously published material. Specifications and price change privileges reserved.

TEKTRONIX, TEK, TEKPROBE, and Tek Secure are registered trademarks of Tektronix, Inc.

DPX, WaveAlert, OpenChoice, and e*Scope are trademarks of Tektronix, Inc.

Contacting Tektronix

Tektronix, Inc.
14200 SW Karl Braun Drive
P.O. Box 500
Beaverton, OR 97077
USA

For product information, sales, service, and technical support:

- In North America, call 1-800-833-9200.
- Worldwide, visit www.tektronix.com to find contacts in your area.

Warranty 16

Tektronix warrants that the product will be free from defects in materials and workmanship for a period of three (3) years from the date of original purchase from an authorized Tektronix distributor. If the product proves defective during this warranty period, Tektronix, at its option, either will repair the defective product without charge for parts and labor, or will provide a replacement in exchange for the defective product. Batteries are excluded from this warranty. Parts, modules and replacement products used by Tektronix for warranty work may be new or reconditioned to like new performance. All replaced parts, modules and products become the property of Tektronix.

In order to obtain service under this warranty, Customer must notify Tektronix of the defect before the expiration of the warranty period and make suitable arrangements for the performance of service. Customer shall be responsible for packaging and shipping the defective product to the service center designated by Tektronix, shipping charges prepaid, and with a copy of customer proof of purchase. Tektronix shall pay for the return of the product to Customer if the shipment is to a location within the country in which the Tektronix service center is located. Customer shall be responsible for paying all shipping charges, duties, taxes, and any other charges for products returned to any other locations.

This warranty shall not apply to any defect, failure or damage caused by improper use or improper or inadequate maintenance and care. Tektronix shall not be obligated to furnish service under this warranty a) to repair damage resulting from attempts by personnel other than Tektronix representatives to install, repair or service the product; b) to repair damage resulting from improper use or connection to incompatible equipment; c) to repair any damage or malfunction caused by the use of non-Tektronix supplies; or d) to service a product that has been modified or integrated with other products when the effect of such modification or integration increases the time or difficulty of servicing the product.

THIS WARRANTY IS GIVEN BY TEKTRONIX WITH RESPECT TO THE PRODUCT IN LIEU OF ANY OTHER WARRANTIES, EXPRESS OR IMPLIED. TEKTRONIX AND ITS VENDORS DISCLAIM ANY IMPLIED WARRANTIES OF MERCHANTABILITY OR FITNESS FOR A PARTICULAR PURPOSE. TEKTRONIX' RESPONSIBILITY TO REPAIR OR REPLACE DEFECTIVE PRODUCTS IS THE SOLE AND EXCLUSIVE REMEDY PROVIDED TO THE CUSTOMER FOR BREACH OF THIS WARRANTY. TEKTRONIX AND ITS VENDORS WILL NOT BE LIABLE FOR ANY INDIRECT, SPECIAL, INCIDENTAL, OR CONSEQUENTIAL DAMAGES IRRESPECTIVE OF WHETHER TEKTRONIX OR THE VENDOR HAS ADVANCE NOTICE OF THE POSSIBILITY OF SUCH DAMAGES.

Table of Contents

General Safety Summary	v
Preface	ix
Contacting Tektronix	x

Getting Started

Initial Setup	1-1
Functional Check	1-2
Probe Compensation	1-3
Signal Path Compensation (SPC)	1-4
Adjusting the Oscilloscope Time and Date	1-4
Product and Feature Description	1-5
Acquisition Features	1-5
Signal Processing Features	1-6
Display Features	1-7
Measurement Features	1-7
Trigger Features	1-8
Convenience Features	1-8
Optional Features	1-9
Transporting the Oscilloscope	1-10
Operating Positions	1-11
Connecting Power	1-11
Using Battery Power	1-12
Operating Safely with Battery Power	1-13
Installing the Battery	1-14
Maximizing Operating Time	1-15
Charging the Battery	1-16
Installing an Application Module	1-17
Installing a Communication Module	1-18

Front-Panel Menus and Controls	1-19
Using the Menu System	1-19
Using the Menu Buttons	1-22
Using the Dedicated Controls	1-24
Identifying Items in the Display	1-27
Using QuickMenus	1-29
Front-Panel Connectors	1-31
Rear-Panel Connectors	1-32
Communication Module Connectors	1-34

Application Examples

Taking Simple Measurements	2-2
Using Autoset	2-2
Selecting Automatic Measurements	2-3
Measuring Two Signals	2-4
Customizing Your Measurements	2-6
Analyzing Signal Detail	2-9
Looking at a Noisy Signal	2-10
Separating the Signal from Noise	2-11
Taking Cursor Measurements	2-12
Using Delay	2-13
Measuring Jitter	2-15
Triggering on a Video Signal	2-16
Capturing a Single-Shot Signal	2-20
Optimizing the Acquisition	2-21
Using the Horizontal Zoom Function	2-22
Saving Data to the Floppy Disk Drive	2-23
Saving Screen Images	2-24
Saving Waveform Data	2-27

Reference

Introduction to Reference	3-1
Acquisition Controls	3-2
Cursor	3-16
YT Cursor Menu	3-16
XY Cursor Menu	3-21
Display	3-23
Hard Copy	3-27
Horizontal Controls	3-31
Measure	3-39
QuickMenu	3-47
Save/Recall	3-48
Trigger Controls	3-58
Utility	3-70
Vertical Controls	3-80
e*ScopeE Web-based Remote Control	3-88

Appendices

Appendix A: Specifications	A-1
Appendix B: Factory Setup	B-1
Appendix C: Accessories	C-1
Appendix D: Probe Basics	D-1
Probe Descriptions	D-1
Probe Compensation	D-2
TekProbe Interface	D-2
Probe Guard	D-3
Ground Leads	D-3
P3010 High-Frequency Compensation	D-4
P3010 Replaceable Parts and Accessories	D-6
P6139A Replaceable Parts and Accessories	D-8
Using Other Probes	D-10
Supported Active Probes and Adapters	D-11
Unsupported Probes	D-12
Appendix E: Performance Verification	E-1
Test Record	E-2
Performance Verification Procedures	E-5
Appendix F: General Care and Cleaning	F-1
General Care	F-1
Cleaning	F-1

Appendix G: Ethernet Setup	G-1
Your Ethernet Network Information	G-1
Entering the Ethernet Network Settings	G-2
Networks That Support DHCP and BOOTP	G-2
Networks That Do Not Support DHCP and BOOTP	G-3
Entering the Network Printer Settings	G-4
Testing Your Ethernet Connection	G-5
Testing the Oscilloscope Connection	G-5
Testing Network Printing	G-5
Testing e*Scope	G-6
Troubleshooting Your Ethernet Connection	G-7
The Instrument Setup Screen	G-8
The Printer Configuration Screen	G-10
The Add Printer Screen	G-11
Other Network Printer Settings	G-13
Testing Network Printers	G-13
Ethernet Error Messages	G-14
Ethernet Settings Form	G-15

Glossary

Index

General Safety Summary

Review the following safety precautions to avoid injury and prevent damage to this product or any products connected to it. To avoid potential hazards, use this product only as specified.

To Avoid Fire or Personal Injury

Use Proper Power Cord. Use only the power cord specified for this product and certified for the country of use.

Connect and Disconnect Properly. Connect the probe output to the measurement instrument before connecting the probe to the circuit under test. Disconnect the probe input and the probe ground from the circuit under test before disconnecting the probe from the measurement instrument.

Ground the Product. When operating with AC power, this product is grounded through the grounding conductor of the power cord. To avoid electric shock, the grounding conductor must be connected to earth ground. Before making connections to the input or output terminals of the product, ensure that the product is properly grounded.

When operating with battery power, this product must still be grounded. To prevent electric shock, always connect a grounding wire between the ground terminal on the rear panel and earth ground.

Observe All Terminal Ratings. To avoid fire or shock hazard, observe all ratings and markings on the product. Consult the product manual for further ratings information before making connections to the product.

Connect the ground lead of the probe to earth ground only.

Replace Batteries Properly. Replace batteries only with the proper type and rating specified.

Recharge Batteries Properly. Recharge batteries for the recommended charge cycle only.

Do Not Operate Without Covers. Do not operate this product with covers or panels removed.

Avoid Exposed Circuitry. Do not touch exposed connections and components when power is present.

Do Not Operate With Suspected Failures. If you suspect there is damage to this product, have it inspected by qualified service personnel.

Do Not Operate in Wet/Damp Conditions.

Do Not Operate in an Explosive Atmosphere.

Keep Product Surfaces Clean and Dry.

Provide Proper Ventilation. Refer to the manual's installation instructions for details on installing the product so it has proper ventilation.

Transportation and Lithium-Ion Batteries

Each TDS3BATB lithium-ion battery pack contains less than 8 grams of lithium, with individual cells each containing less than 1.5 grams of lithium, as measured by International Civil Aviation Organization (ICAO) standards. Consult your air carrier for applicability and determination of any special lithium-ion battery transportation requirements.

Mercury Notification

This oscilloscope uses an LCD backlight lamp that contains mercury. Disposal may be regulated due to environmental considerations. Please contact your local authorities or the Electronics Industries Alliance (www.eiae.org) for disposal or recycling information.

Safety Terms and Symbols

Terms in This Manual. These terms may appear in this manual:



WARNING. *Warning statements identify conditions or practices that could result in injury or loss of life.*



CAUTION. *Caution statements identify conditions or practices that could result in damage to this product or other property.*

Terms on the Product. These terms may appear on the product:

DANGER indicates an injury hazard immediately accessible as you read the marking.

WARNING indicates an injury hazard not immediately accessible as you read the marking.

CAUTION indicates a hazard to property including the product.

Symbols on the Product. These symbols may appear on the product:



WARNING
High Voltage



Protective Ground
(Earth) Terminal



CAUTION
Refer to Manual



Battery
Information



Ethernet Port



Chassis Ground

Preventing Electrostatic Damage



CAUTION. *Electrostatic discharge (ESD) can damage components in the oscilloscope and its accessories. To prevent ESD, observe these precautions when directed to do so.*

Use a Ground Strap. Wear a grounded antistatic wrist strap to discharge the static voltage from your body while installing or removing sensitive components.

Use a Safe Work Area. Do not use any devices capable of generating or holding a static charge in the work area where you install or remove sensitive components. Avoid handling sensitive components in areas that have a floor or benchtop surface capable of generating a static charge.

Handle Components Carefully. Do not slide sensitive components over any surface. Do not touch exposed connector pins. Handle sensitive components as little as possible.

Transport and Store Carefully. Transport and store sensitive components in a static-protected bag or container.

Battery Recycling

This product may contain optional Lithium ion (Li-ion) batteries which must be recycled or disposed of properly at the end of product life. There may be specific legal requirements for battery collection and disposal in your community. Contact your local electronics recycler, relevant legal authority, or your Tektronix representative for assistance in recycling batteries.

Environmental Considerations

This section provides information about the environmental impact of the product.

Product End-of-Life Handling

Observe the following guidelines when recycling an instrument or component:

Equipment Recycling. Production of this equipment required the extraction and use of natural resources. The equipment may contain substances that could be harmful to the environment or human health if improperly handled at the product's end of life. In order to avoid release of such substances into the environment and to reduce the use of natural resources, we encourage you to recycle this product in an appropriate system that will ensure that most of the materials are reused or recycled appropriately.

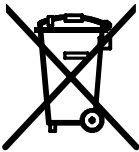

The symbol shown to the left indicates that this product complies with the European Union's requirements according to Directive 2002/96/EC on waste electrical and electronic equipment (WEEE). For information about recycling options, check the Support/Service section of the Tektronix Web site (www.tektronix.com).

Battery Recycling. This product may contain a Nickel Cadmium (NiCd) or lithium ion (Li-ion) rechargeable battery, which must be recycled or disposed of properly. Please properly dispose of or recycle the battery according to local government regulations.

Mercury Notification. This product uses an LCD backlight lamp that contains mercury. Disposal may be regulated due to environmental considerations. Please contact your local authorities or, within the United States, the Electronics Industries Alliance (www.eiae.org) for disposal or recycling information.

Transporting Batteries

The lithium ion rechargeable battery pack in this product contains less than 8 grams of equivalent lithium content, with individual cells containing less than 1.5 grams of equivalent lithium, as measured by International Civil Aviation Organization (ICAO) standards. Consult your air carrier for applicability and determination of any special lithium ion battery transportation requirements.

Restriction of Hazardous Substances

This product has been classified as Monitoring and Control equipment, and is outside the scope of the 2002/95/EC RoHS Directive. This product is known to contain lead, cadmium, mercury, and hexavalent chromium.

Preface

This User Manual describes the capabilities, operation, and applications of the TDS3000B Series Digital Phosphor Oscilloscopes. The following table shows you where to find information in this manual.

If you are looking for:	Turn to:
Product overview	<i>Product and Feature Description</i> on page 1-5
Installation information	<i>Connect Power</i> on page 1-12
Basic operating instructions	<i>Front Panel Controls</i> on page 1-19
Details about a product feature	<i>Reference</i> on page 3-1 Look up the front-panel button for the feature
Application examples	<i>Application Examples</i> on page 2-1
Information about selecting a language	<i>Configure System</i> on page 3-71
Information about battery operation	<i>Using Battery Power</i> on page 1-12
Information about making a hard copy	<i>Hard Copy</i> on page 3-27
Information about probes and probe-power limitations	<i>Probe Basics</i> on page D-1
Technical specifications	<i>Specifications</i> on page A-1
Recommended accessories	<i>Accessories</i> on page C-1

Contacting Tektronix

Tektronix, Inc.
14200 SW Karl Braun Drive
P.O. Box 500
Beaverton, OR 97077
USA

For product information, sales, service, and technical support:

- In North America, call 1-800-833-9200.
- Worldwide, visit www.tektronix.com to find contacts in your area.



Getting Started



Getting Started

In addition to a product and feature description, this chapter covers the following topics:

- How to perform a quick functional check, install and compensate passive probes, compensate the signal path, and set the time and date.
- How to install the power cord, battery pack, and operate the oscilloscope safely with battery power
- How to install application modules and communication modules
- How to use the menu system
- How to identify the oscilloscope controls and connectors

Initial Setup

The following procedures describe how to quickly verify that the oscilloscope is powering up and functioning correctly, compensate passive probes using the built-in compensation signal, run the signal path compensation (SPC) routine for maximum signal accuracy, and set the time and date.

- You should perform all initial setup procedures the first time you use the oscilloscope.
- You should perform the probe compensation procedure whenever you attach a passive probe for the first time to any input channel.
- You should run the signal path compensation routine whenever the ambient temperature changes by 10° C or more.

Functional Check

Perform this quick functional check to verify that your oscilloscope is operating correctly.

-
1. Connect the oscilloscope power cable (refer to page 1-11).

2. Turn on the oscilloscope.

Wait for the confirmation that all self tests have passed.

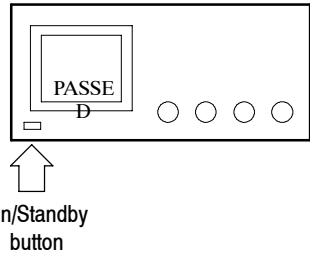

-
3. Connect the oscilloscope probe to channel 1. Attach the probe tip and reference lead to the **PROBE COMP** connectors.

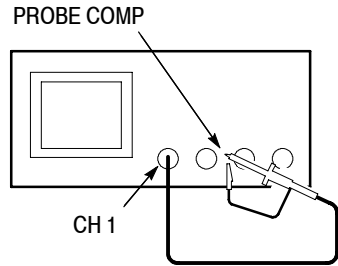

-
4. Push the **AUTOSET** button. You should see a square wave in the display (approximately 5 V at 1 kHz).

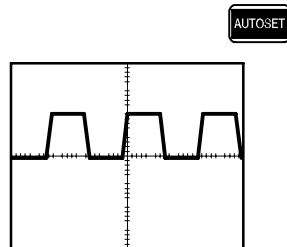

Probe Compensation

Perform this adjustment to match your probe to the input channel. This should be done whenever you attach a passive probe for the first time to any input channel.

1. Connect the oscilloscope probe to channel 1. Attach the probe tip and reference lead to the **PROBE COMP** connectors, then push **AUTOSET**.

If using the probe hook-tip, ensure a proper connection by firmly twisting the tip onto the probe.

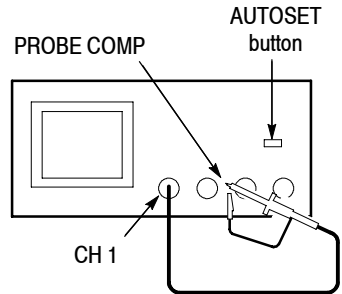

2. Check the shape of the displayed waveform.

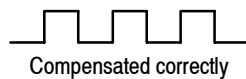

3. If necessary, adjust your probe.

Repeat as necessary.

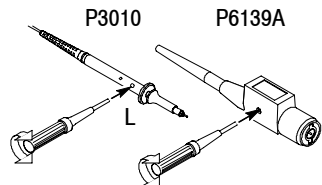

NOTE. See Appendix D: Probe Basics for more information about the probes provided with your oscilloscope.

Signal Path Compensation (SPC)

The signal path compensation (SPC) routine optimizes the oscilloscope signal path for maximum measurement accuracy. You can run the routine anytime but you should always run the routine if the ambient temperature changes by 10° C or more.

To compensate the signal path, do the following steps:

1. Disconnect any probes or cables from the channel input connectors.
2. Push the **UTILITY** button.
3. Push the **System** screen button to select **Cal.**
4. Push the **Signal Path** screen button.
5. Push **OK Compensate Signal Path**. This procedure takes several minutes to complete.

NOTE. The signal path compensation does not include calibration to the probe tip.

Adjusting the Oscilloscope Time and Date

To set your oscilloscope to the current date and time, do the following steps:

1. Push the **UTILITY** button.
2. Push the **System** menu button to select **Config.**
3. Push the **Set Date & Time** menu button. Use the side menu buttons to set the date and time values.
4. Push the **OK Enter Date/Time** menu button to set the instrument date and time.

Product and Feature Description

The TDS3000B Series Digital Phosphor Oscilloscope family consists of the models in the table below.

Model	Bandwidth	Maximum sample rate
TDS3012B (2 Ch), TDS3014B (4 Ch)	100 MHz	1.25 GS/s
TDS3024B (4 Ch)	200 MHz	2.5 GS/s
TDS3032B (2 Ch), TDS3034B (4 Ch)	300 MHz	2.5 GS/s
TDS3044B (4 Ch)	400 MHz	5 GS/s
TDS3052B (2 Ch), TDS3054B (4 Ch)	500 MHz	5 GS/s
TDS3064B (4 Ch)	600 MHz	5 GS/s

Acquisition Features

WaveAlert™ Waveform Anomaly Detection. Automatically detects anomalous waveforms by comparing the current waveform to the previous waveform. Sets how the oscilloscope responds: stop on anomaly, beep on anomaly, and save anomalous waveform to disk. Useful for capturing signal glitches and intermittent waveform errors. See page 3-13.

Separate Digitizers. Ensure accurate timing measurements with separate digitizers for each channel. Each digitizer can sample at up to the maximum sample rate; acquisition on all channels is always concurrent to provide full single-shot bandwidth on each channel.

Normal Acquisition. Acquire 10,000 point waveforms to capture horizontal detail and then use the zoom  function to analyze the detail. See page 3-12.

Fast Trigger Acquisition. Acquire up to 3,600 waveforms per second (300 MHz - 600 MHz models, 500 point mode) to see rapidly changing signals or intermittent signal irregularities. See page 3-12.

Pretrigger. You can capture signals that occur before the trigger point. You can position the trigger point at the beginning of the acquisition, at the end, or at any location in between. See page 3-31.

Delay. You can also delay the acquisition so that it starts after the trigger point. Use delay when you want to acquire the signal at a specific time after the trigger point. See page 3-33.

Peak Detect. See pulses as narrow as 1 ns even at the slower time base settings. Peak Detect helps you see noise and glitches in your signal. See page 3-9.

Signal Processing Features

Average. Apply averaging to your signal to remove uncorrelated noise and improve measurement accuracy. See page 3-10.

Envelope. Use envelope to capture and display the maximum variation of a signal. See page 3-10.

Waveform Math. Use waveform math to add, subtract, multiply, or divide waveforms. For example, you can use math to analyze differential signals or calculate a power waveform. See page 3-84.

Display Features

Color LCD Display. Identify and differentiate waveforms easily with color coding. Waveforms, readouts, and buttons are color matched to increase productivity and reduce operating errors. See page 3-25.

Digital Phosphor. A Digital Phosphor Oscilloscope can clearly display intensity modulation in your signals. The oscilloscope automatically overlays subsequent acquisitions and then decays them to simulate the writing and decay of the phosphor in an analog oscilloscope CRT. This feature results in an intensity-graded waveform display that shows the information contained in the intensity modulation. See page 3-5.

Signal Preview. Use the preview feature to optimize the control settings when setting up a single-shot acquisition. As you adjust the controls, the adjustments modify the current acquisition to show a preview of how the next acquisition should appear. See page 3-8.

Measurement Features

Cursors. Use cursors to take simple voltage, time, and frequency measurements. See page 3-16.

Automatic Measurements. Choose from a list of automatic waveform measurements. You can customize the measurements by changing reference levels or by adding measurement gating. See page 3-39.

XY Waveform Cursors. Use cursors to take measurements on XY waveforms. See page 3-21.

Trigger Features

Dual Triggers. Use the main (A) trigger system alone or add the B trigger to capture more complex events. You can use the A and B triggers together to set up a wait-for-time or wait-for-events trigger. See page 3-59.

Video Trigger. Trigger on video fields or lines to see a stable display of standard video signals. See page 3-69.

Alternating Trigger. Sequentially use each active channel as a trigger source, from the lowest-numbered active channel to the highest-numbered active channel. See page 3-67.

External Triggering on Four-Channel Instruments. All models have an external trigger input. Four-channel models have the external trigger connector on the back of the instrument. Two-channel models have the external trigger connector on the front panel.

Convenience Features

e*Scope™ Web-based Remote Control. Access your TDS3000B through the Internet, from across a room to across the world. See page 3-88.

Built-in Ethernet. Connect your TDS3000B Series oscilloscope to the Internet using the built-in 10BaseT Ethernet port, for e*Scope access or printing screen images to network printers. See page G-1.

Autoset. Use Autoset to quickly set up the vertical, horizontal, and trigger controls for a usable display. See page 3-4.

Scope QuickMenu. Use the built-in Scope QuickMenu for simplified oscilloscope operation. See page 1-29.

Single Sequence. One button sets the trigger parameters to the correct settings for a single-shot acquisition (or single-sequence acquisition). See page 3-3.

Floppy Disk. Use the built-in floppy disk to store and recall waveforms and setups, as well as upgrade the oscilloscope firmware and install new features. See page 3-52.

Probe Support. Use the standard probes or choose an optional probe for a specific application. See page D-1 for information and limitations.

Multilingual User Interface. On-screen menus and messages are in 11 languages. See page 3-71.

Optional Features

Application Modules. Install powerful application modules to add new test and measurement features. See page C-2.

Communication Modules. Install a communication module to add RS-232, GPIB, or VGA ports for remote programmability or displaying the oscilloscope screen on a monitor. See page 1-18.

Battery Power. Install a rechargeable Lithium-Ion battery pack (TDS3BATB) to use the oscilloscope without line power. See page 1-12.

Plug-in Thermal Printer. Install instrument-powered thermal printer TDS3PRT to print monochrome hard copy of your TDS3000B screens. See page C-4.

Transporting the Oscilloscope

When transporting the oscilloscope, wrap the cord around the handle as shown below. Use the supplied cord retainer if the power plug does not have a molded-in retainer. The oscilloscope front cover has a convenient place to store the Reference Manual.

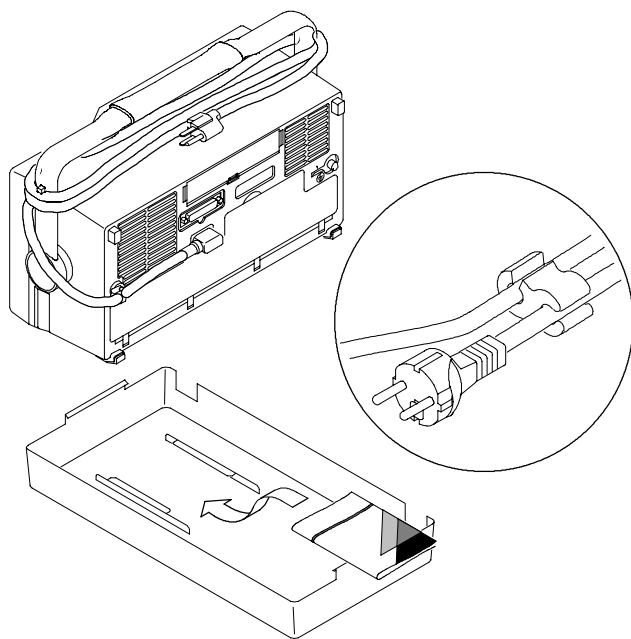

If you are not using a battery, use the accessory tray in the battery compartment to store probes and other accessories.



CAUTION. To avoid damage to the disk drive, do not transport the oscilloscope with a floppy disk in the disk drive.

Operating Positions

Use the handle and feet to place the oscilloscope in a convenient operating position.

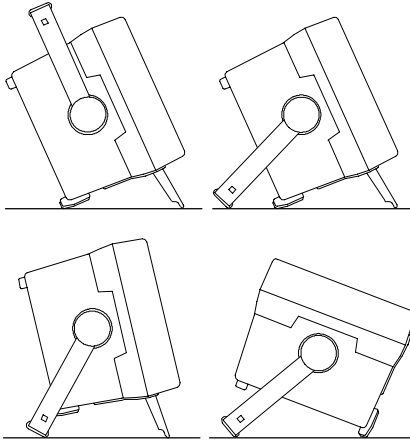

Connecting Power

To connect a power cord, do these steps:

1. Open the strain relief and slip it over the power cord.
2. Snap the strain relief into its hole in the rear panel of the oscilloscope.
3. Connect the power cord to the power input connector.

You can operate the oscilloscope from a grounded mains supply with line voltage between 90 V_{AC} and 250 V_{AC} and frequency between 47 Hz and 440 Hz. The oscilloscope is grounded through the power cord. The line fuse is internal and is not user replaceable.

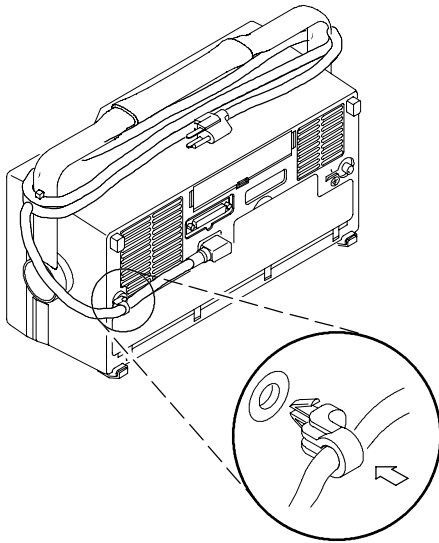

Using Battery Power

You can operate the oscilloscope continuously for approximately three hours from the optional rechargeable TDS3BATB battery pack. A triangle icon in the display (\triangle) shows when the battery is in use, a power-plug icon ($\oplus \sim$) shows when line power is connected, and a gauge icon ($\square \text{ } \oplus$) shows the charge level in the battery. The oscilloscope turns off automatically when the battery runs low; the screen may turn white a few minutes before the automatic shutdown.

Refer to the *General Safety Summary* for information about proper battery disposal.

Operating Safely with Battery Power



WARNING. To avoid electric shock, connect the rear-panel ground terminal to earth ground when operating the instrument from battery power.

For safe operation, the oscilloscope chassis should always remain at earth ground potential. Without a connection between the chassis and earth ground, you can receive a shock from exposed metal on the chassis if you connect an input to a hazardous voltage ($>30 V_{RMS}$, $>42 V_{pk}$). Protection against this condition is provided when you attach the Tektronix-supplied grounding wire from the terminal on the rear panel to earth ground. If you use a different grounding wire, it must be at least 18 gauge.

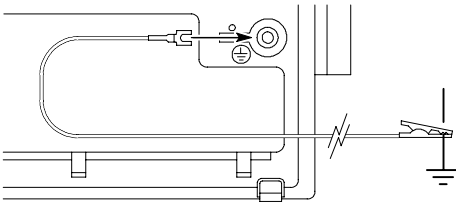

If you choose not to attach the grounding wire, you are not protected against electric shock if you connect the oscilloscope to a hazardous voltage. You can still use the oscilloscope if you do not connect a signal greater than $30 V_{RMS}$ ($42 V_{pk}$) to the probe tip, the BNC connector center, or the common lead. Ensure that all probe common leads are connected to the same voltage. Also, do not connect a grounded device, such as a printer or computer, to the oscilloscope.



WARNING. Hazardous voltages may exist in unexpected places due to faulty circuitry in the device under test.

Installing the Battery

To install the optional battery pack, do these steps:

1. Open the battery compartment door on the rear panel.
2. Remove the accessory tray.

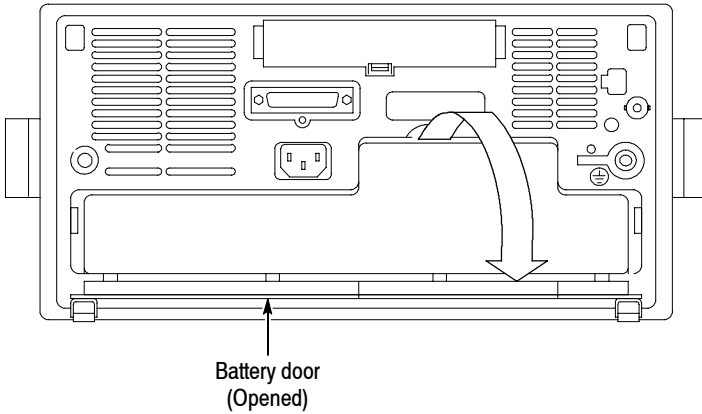

3. Slide the battery into the compartment and press it in from both sides until you hear the latches click.
4. Press on both sides of the battery compartment door to snap it closed.

To remove the battery, do these steps:

1. Open the battery compartment door.
2. Raise the handles on each side of the battery and use them to pull the battery out of the oscilloscope.

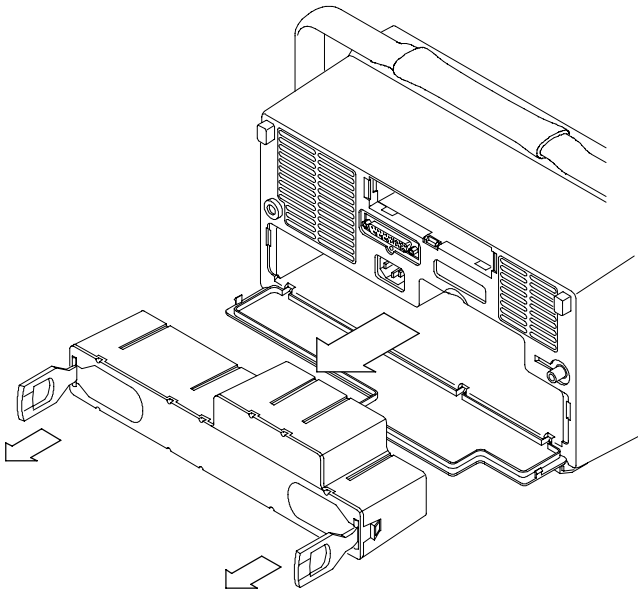

Maximizing Operating Time

To maximize the time that the oscilloscope can operate from a full battery charge, consider doing these things:

- Reduce the display backlight intensity (see page 3-23)
- Disconnect unused active probes
- Only use passive probes

Charging the Battery

The battery charges automatically when the oscilloscope is connected to line power. You can also charge the battery with the optional external charger (TDS3CHG).

Configuration	Typical charging time
Battery charging in oscilloscope with oscilloscope turned on or off	30 hours
Battery charging with TDS3CHG external charger	5 hours

NOTE. Charge the battery before using it for the first time or after prolonged storage.

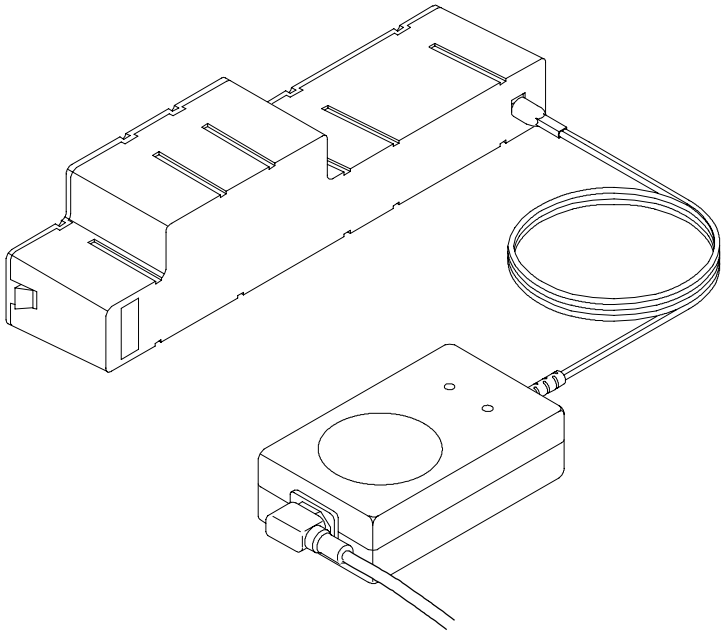

Installing an Application Module



CAUTION. To avoid damage to the oscilloscope or application module, observe the ESD precautions described on page viii.

Optional application packages are available to extend the capability of your oscilloscope. You can install up to four application modules at one time. Application modules can go into the two slots with windows in the upper right corner of the front panel. Two additional slots are directly behind the two you can see.

Refer to the *TDS3000 & TDS3000B Series Application Module Installation Instructions* that came with your application module for instructions on installing and testing an application module.

NOTE. If you remove an application module, the features provided by the application module become unavailable. You can reinstall the module to restore the features.

Installing a Communication Module



CAUTION. To avoid damage to the oscilloscope or communication module, observe the ESD precautions described on page viii.

To install one of the optional communications modules, do these steps:

1. Turn the oscilloscope power off.
2. Press down on the latching tab to remove the blank cover.
3. Slide the communication module into the compartment until the internal connectors are seated and the latching tab locks.
4. Turn power on. The communication module is now ready for your use.

To remove a communication module, do these steps:

1. Turn the oscilloscope power off.
2. Press down on the latching tab and then use a small screwdriver to alternately pry out the sides of the communication module.
3. Slide out the communication module and store it in an ESD-shielded bag. Install the blank cover if no other communication module is to be installed.

Communication module port	For more information, see
GPIB	<i>Hard Copy on page 3-27 of this manual and the TDS3000 & TDS3000B Series Programmer Manual</i>
RS-232	
VGA	Page A-9 in this manual

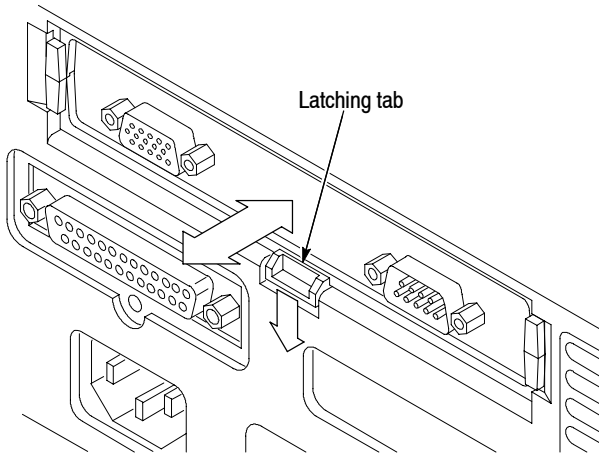

Front-Panel Menus and Controls

The front panel has buttons and controls for the functions you use most often. The front panel has menus to access more specialized functions.

Using the Menu System

To use the menu system, follow the steps shown on the next two pages.

- 1. Push a dark-colored front-panel menu button to display the menu you want to use.

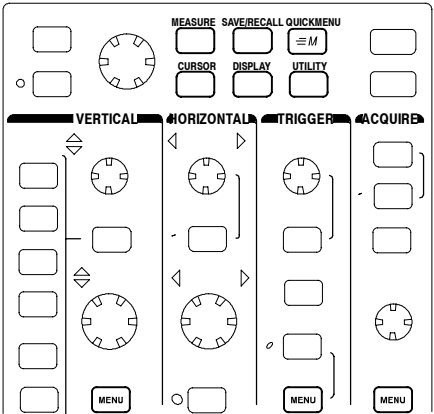

- 2. Push a bottom screen button to select a menu item. If a pop-up menu appears, continue to push the screen button to select an item from the pop-up menu.

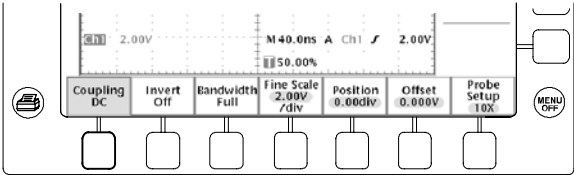

3. Push a side screen button to choose a menu item. If the menu item contains more than one choice, push the side screen button again to make the choice.

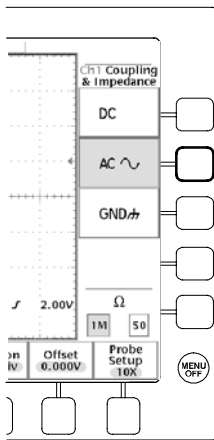

4. Certain menu choices require you to set a numerical value to complete the setup. Use the general purpose knob to adjust the parameter value. Push the COARSE button to make larger adjustments.

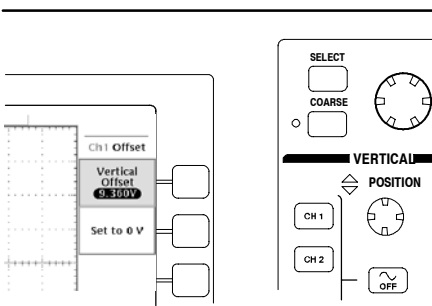

Using the Menu Buttons

You can use the menu buttons to perform many functions in the oscilloscope.

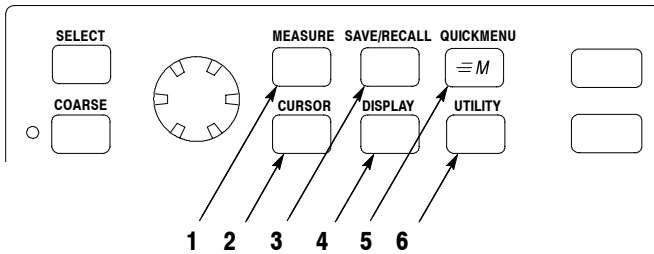

1. **MEASURE.** Performs automated measurements of waveforms.
2. **CURSOR.** Activates the cursors.
3. **SAVE/RECALL.** Saves and recalls setups and waveforms to memory or a floppy disk.
4. **DISPLAY.** Changes the appearance of waveforms and the display screen.
5. **QUICKMENU.** Activates QuickMenus such as the built-in Scope QuickMenu.
6. **UTILITY.** Activates the system utility functions, such as selecting a language.

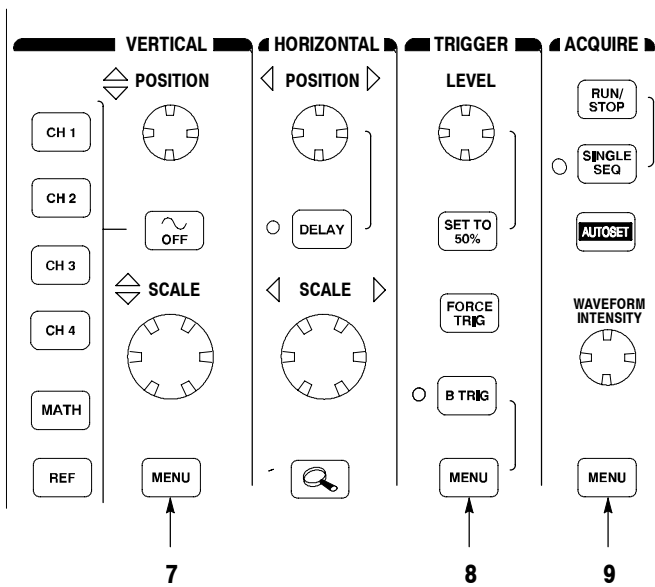

7. Vertical MENU. Adjusts the scale, position, and offset of waveforms. Sets the input parameters.
8. Trigger MENU. Adjusts the trigger functions.
9. Acquire MENU. Sets the acquisition modes and horizontal resolution, and resets the delay time.

Using the Dedicated Controls

These dedicated buttons and controls generally control waveforms and cursors without the use of menus.

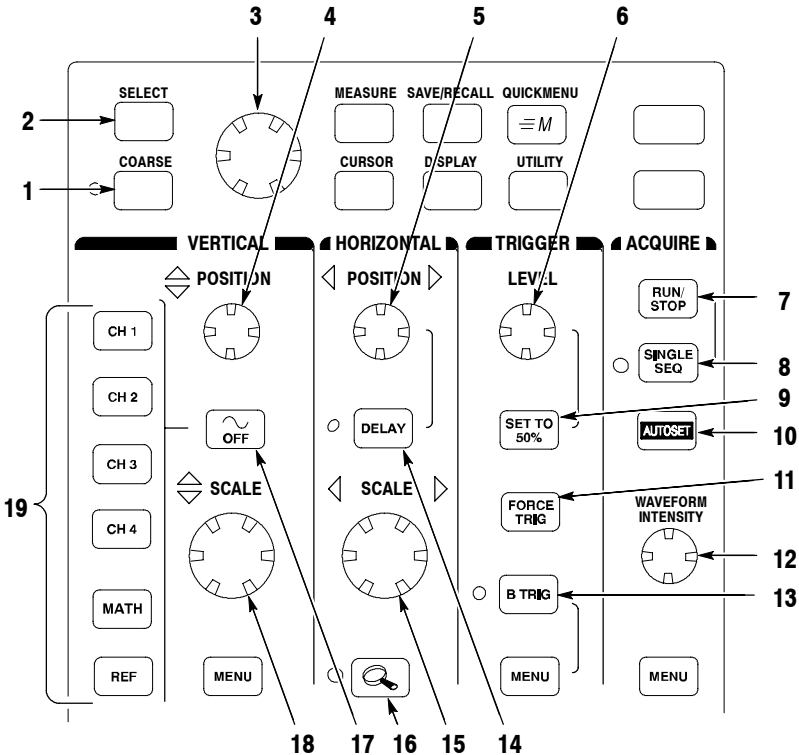

1. **COARSE.** Causes the general purpose knob and position knobs to make adjustments more quickly.
2. **SELECT.** Toggles between the two cursors to select the active cursor.
3. **General purpose knob.** Moves the cursors. Sets numerical parameter values for some menu items. Push **COARSE** to make adjustments quickly.
4. **Vertical POSITION.** Adjusts the vertical position of the selected waveform. Push **COARSE** to make adjustments more quickly.
5. **Horizontal POSITION.** Adjusts the trigger point location relative to the acquired waveforms. Push **COARSE** to make adjustments quickly.
6. **Trigger LEVEL.** Adjusts the trigger level.
7. **RUN/STOP.** Stops and restarts acquisition.
8. **SINGLE SEQ.** Sets acquisition, display, and trigger parameters for a single-shot (single-sequence) acquisition.
9. **SET TO 50%.** Sets the trigger level to the midpoint of the waveform.
10. **AUTOSET.** Automatically sets the vertical, horizontal, and trigger controls for a usable display.
11. **FORCE TRIG.** Forces an immediate trigger event.
12. **WAVEFORM INTENSITY.** Controls waveform intensity.
13. **B TRIG.** Activates the B trigger. Changes the trigger menu to set the B-trigger parameters.
14. **DELAY.** Enables delayed acquisition relative to the trigger event. Use horizontal **POSITION** to set the amount of delay.

- 15. Horizontal SCALE. Adjusts the horizontal scale factor.
- 16. Horizontal zoom. Splits the screen and magnifies the current acquisition horizontally.
- 17. Waveform OFF. Removes selected waveform from the display.
- 18. Vertical SCALE. Adjusts selected waveform vertical scale factor.
- 19. CH1, CH2, (CH3, CH4,) MATH. Displays a waveform and chooses the selected waveform. REF shows the reference waveform menu.

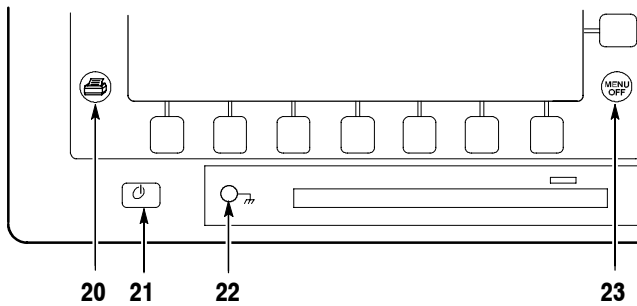

- 20. Hard copy. Initiates a hard copy using the port selected in the Utility menu.
- 21. Power switch. Turns power to on or standby. Power-up time varies from about 15 seconds to 45 seconds, depending on the oscilloscope internal calibration process.
- 22. Wrist-strap ground. Connect a wrist strap when working with ESD-sensitive circuits. This connector is not a safety ground.
- 23. MENU OFF. Clears menu from the display.

Identifying Items in the Display

The following items may appear in the display; not all items are visible at any given time. Some readouts move outside the graticule area when menus are turned off.

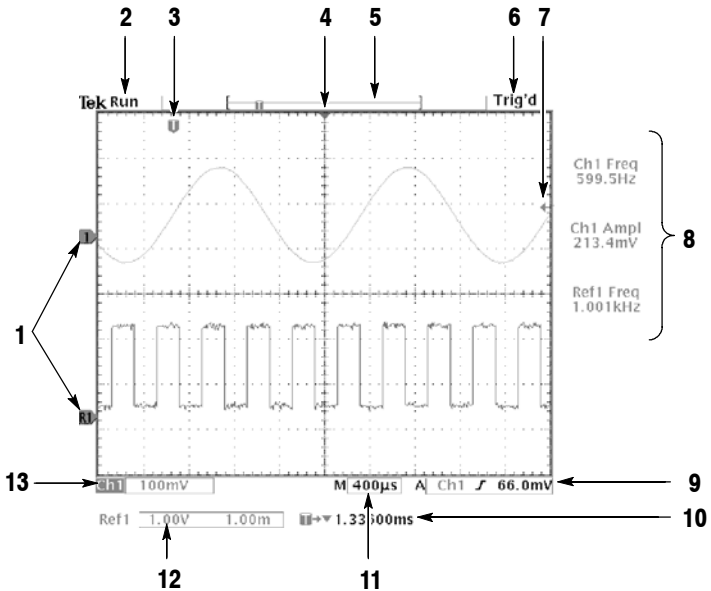

1. Waveform baseline icons show the zero-volt level of the waveforms (ignoring the effect of offset). The icon colors correspond to the waveform colors.
2. Acquisition readout shows when acquisition is running, stopped, or when acquisition preview is in effect.
3. Trigger position icon shows the trigger location in the waveforms.
4. Expansion point icon shows the point that the horizontal scale expands and compresses around.

5. Waveform record icon shows the trigger location relative to the waveform record. The line color corresponds to the selected waveform color.
6. Trigger status readout show trigger status.
7. Trigger level icon shows the trigger level on the waveform. The icon color corresponds to the trigger source channel color.
8. Cursor and measurement readouts show results and messages.
9. Trigger readouts show the trigger sources, slopes, and levels, and position.
10. Readout shows the delay setting or the trigger location within the record.
11. Horizontal readout shows the main or zoom time/division.
12. Auxiliary waveform readouts show the vertical and horizontal scale factors of the math or reference waveforms.
13. Channel readouts show the channel scale factor, coupling, input resistance, bandwidth limit, and invert status.

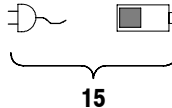
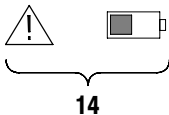

14. Triangle icon with the battery icon indicates a battery is installed and battery power is in use. The battery icon shows the approximate charge level of the battery. See page 1-13 for important safety information.
15. Power-plug icon with the battery icon indicates a battery is installed but line power is in use. The battery may be charging. The battery icon shows the approximate charge level.

Using QuickMenus

The QuickMenu feature simplifies the use of the oscilloscope. When you push the QUICKMENU button, a set of frequently used menu functions show on the display. Then, push the screen buttons around the display to operate the QuickMenu. See page 3-47 for general instructions to operate QuickMenus.

Using the Scope QuickMenu. Scope is one type of QuickMenu that you can use to control the basic oscilloscope functions. You can perform many tasks without using the regular menu system. If you need to use a function that is not contained in the Scope QuickMenu, push the button you would normally push to access that function. For example, if you want to add an automatic measurement, push the MEASURE button to set up the measurement. Then, push the QUICKMENU button to return to the Scope QuickMenu with the measurement also in the display.

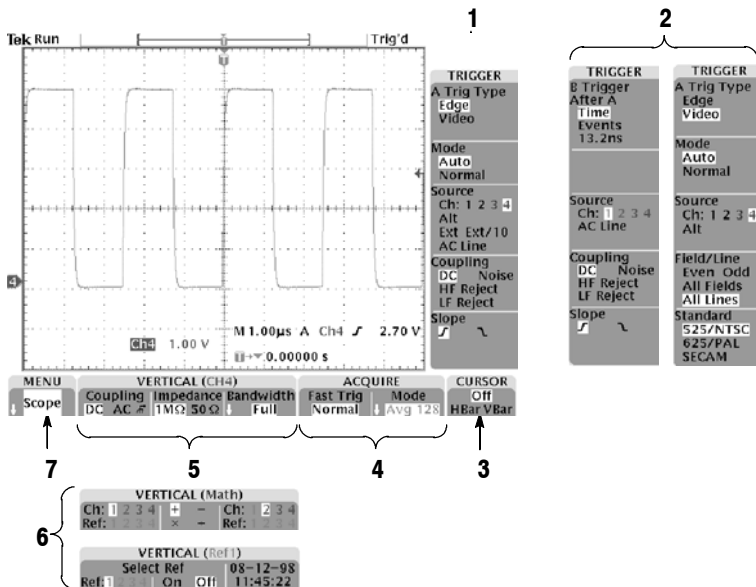

1. Edge Trigger controls. Push these screen buttons to set trigger parameters for edge trigger.
2. Trigger controls if either B trigger or video trigger is selected.
3. Cursor control. Push this screen button to turn on cursors and select the cursor type. Push the SELECT button to toggle between the two cursors to select the active cursor. Use the general purpose knob to move the active cursor.
4. Acquisition controls. Push these screen buttons to set acquisition parameters.
5. Channel vertical controls. Push these screen buttons to set vertical controls for the selected channel. Use the CH1, CH2, CH3, CH4, MATH, and REF buttons to select the channel you want to control.
6. Vertical controls if either the math waveform or a reference waveform is selected.
7. Menu. Push this screen button to select a specific QuickMenu display if more than one is available.

NOTE. Items in the Scope QuickMenu not mentioned above are also contained in the regular display. Those items are described on page 1-27.

Other QuickMenus. Some optional application packages include a custom QuickMenu display. Those QuickMenus contain specific features that are important for the application.

Front-Panel Connectors

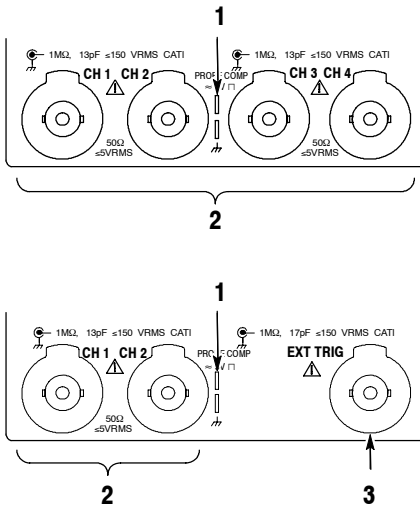

1. PROBE COMP. Square wave signal source to compensate probes.
2. CH 1, CH 2, (CH 3, CH 4). Channel inputs with TekProbe interface.
3. EXT TRIG. External trigger input with TekProbe interface (two-channel models only).

Rear-Panel Connectors

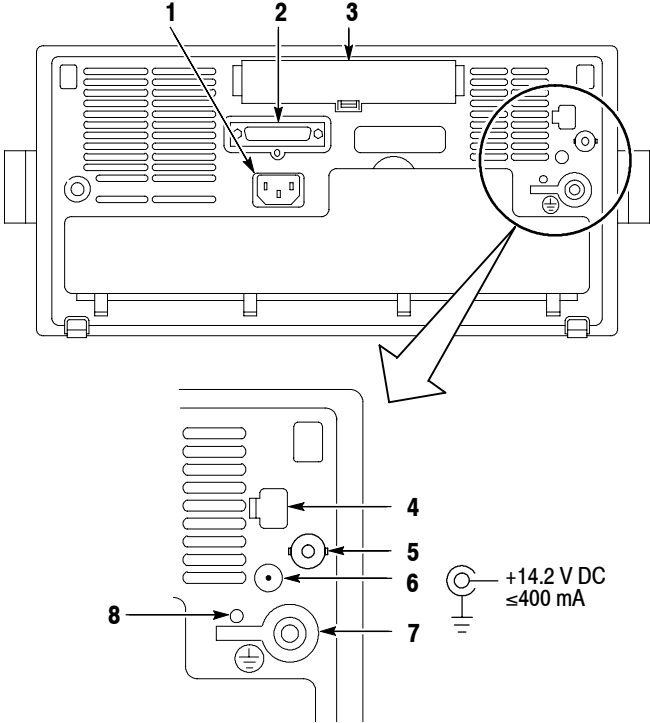

1. Power input. Attach to an AC power line with integral safety ground.
2. Parallel printer port. Connect to a printer to make hard copies.
3. Communication Module compartment. Install optional communication modules or the thermal printer.
4. Ethernet port. Connects the oscilloscope to a 10Base-T local area network. Available on all models.
5. External Trigger input (four-channel models only). See page A-6 for input specifications.
6. DC power output. Provides ~15 V DC power to accessories or to the plug-in TDS3PRT thermal printer.
7. Ground terminal. Connect to earth ground when using battery power. See page 1-13 for important safety information.
8. CAL switch. For use by authorized service personnel only.

Communication Module Connectors

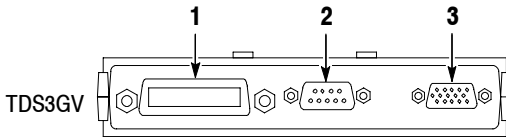

1. GPIB port. Connect to a controller for remote programmability.
2. RS-232 port. Connect to a controller or terminal for remote programmability or printing.
3. VGA port. Connect to a VGA monitor to display the screen image.



Application Examples



Application Examples

This section presents five common oscilloscope applications:

- Taking simple measurements
- Analyzing signal detail
- Triggering on a video signal
- Capturing a single-shot signal
- Using the disk drive

Each application example highlights different features of the oscilloscope and gives you ideas about using the oscilloscope to solve test problems.

Taking Simple Measurements

You need to see a signal in a circuit, but you do not know the signal amplitude or frequency. Connect the oscilloscope to quickly display the signal and then measure its frequency and peak-to-peak amplitude.

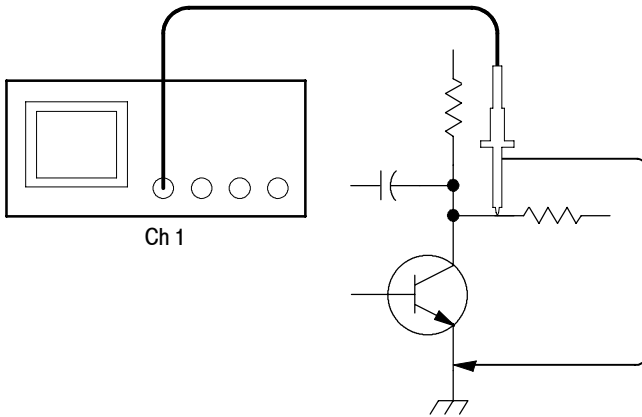

Using Autoset

To quickly display a signal, do these steps:

1. Connect the channel 1 probe to the signal.
2. Push the **AUTOSET** button.

The oscilloscope sets vertical, horizontal, and trigger controls automatically. You can manually adjust any of these controls if you need to optimize the display of the waveform.

When you are using more than one channel, the autoset function sets the vertical controls for each channel and uses the lowest-numbered active channel to set the horizontal and trigger controls.

Selecting Automatic Measurements

The oscilloscope can take automatic measurements of most displayed signals. To measure signal frequency and peak-to-peak amplitude, do these steps:

1. Push the **MEASURE** button to see the measurement menu.
2. Push the **CH 1** button and then push the **Select Measurement for Ch1** screen button.
3. Select the **Frequency** measurement.
4. Push the **more** screen button until you can select the **Pk-Pk** measurement.
5. Push the **MENU OFF** button.

The measurements show on the screen and update as the signal changes.

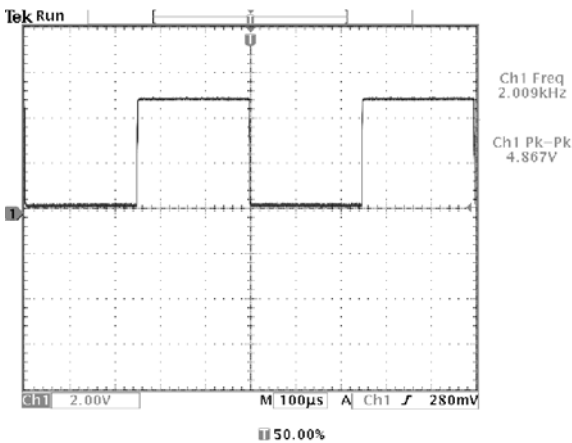

Measuring Two Signals

You are testing a piece of equipment and need to measure the gain of its audio amplifier. You have an audio generator that can inject a test signal at the amplifier input. Connect two oscilloscope channels to the amplifier input and output as shown. Measure both signal levels and use these measurements to calculate the gain.

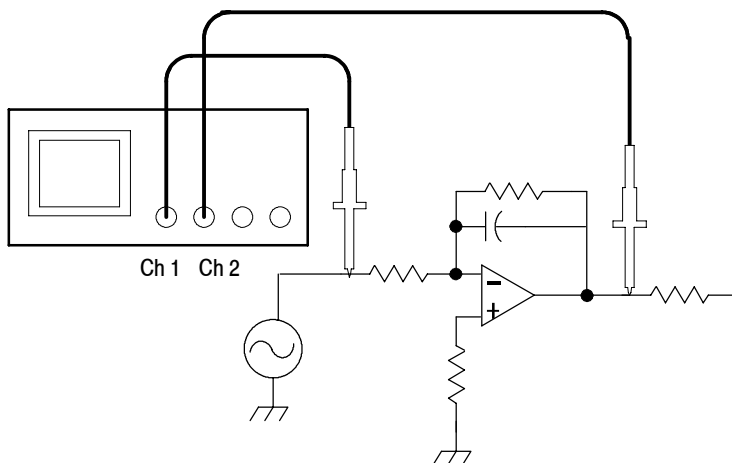

To display the signals connected to channels 1 and 2, do these steps:

1. Push the **CH 1** and **CH 2** buttons to activate both channels.
2. Push the **AUTOSET** button.

To select measurements for the two channels, do these steps:

1. Push the **MEASURE** button to see the measurement menu.
2. Push the **CH 1** button and then push the **Select Measurement for Ch1** screen button.
3. Select the **Amplitude** measurement.
4. Push the **CH 2** button and then push the **Select Measurement for Ch2** screen button.
5. Select the **Amplitude** measurement.

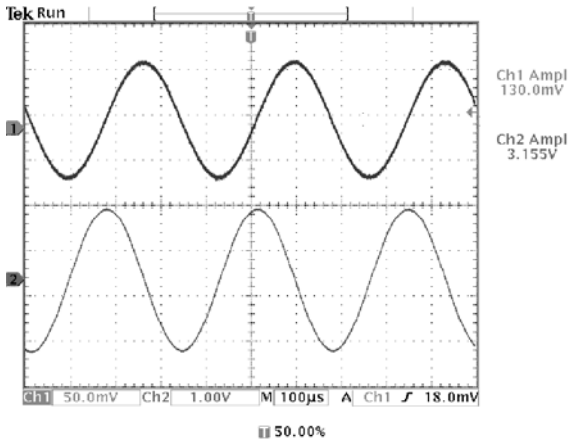

6. Calculate the amplifier gain using the following equations:

$$\text{Gain} = \frac{\text{output amplitude}}{\text{input amplitude}} = \frac{3.155 \text{ V}}{130.0 \text{ mV}} = 24.27$$

$$\text{Gain (dB)} = 20 \times \log(24.27) = 27.7 \text{ dB}$$

Customizing Your Measurements

In this example you want to verify that the incoming signal to a piece of digital equipment meets its specifications. Specifically, the transition time from a low logic level (0.8 V) to a high logic level (2.0 V) must be 10 ns or less.

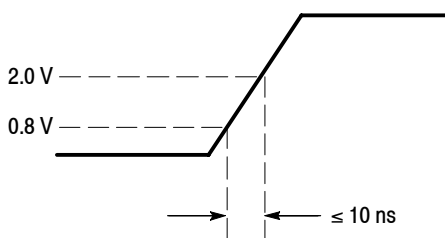

To select the rise time measurement, do these steps:

1. Push the **MEASURE** button to see the measurement menu.
2. Push the **CH 1** button and then the **Select Measurement for Ch1** screen button.
3. Select the **Rise Time** measurement.

Rise time is typically measured between the 10% and 90% amplitude levels of a signal; these are the default reference levels the oscilloscope uses for rise time measurements. However, in this example you need to measure the time the signal takes to pass between the 0.8 V and 2.0 V levels.

You can customize the rise time measurement to measure the signal transition time between any two reference levels. You can set each of those reference levels to a specific percent of the signal amplitude or to a specific level in vertical units (such as volts or amperes).

Setting Reference Levels. To set the reference levels to specific voltages, do these steps:

1. Push the **Reference Levels** screen button.
2. Push the **Set Levels in** screen button to select **units**.
3. Push the **High Ref** screen button.
4. Use the general purpose knob to select **2.0 V**.
5. Push the **Low Ref** screen button.
6. Use the general purpose knob to select **800 mV**.

The measurement verifies that the transition time (3.842 ns) meets the specification (≤ 10 ns).

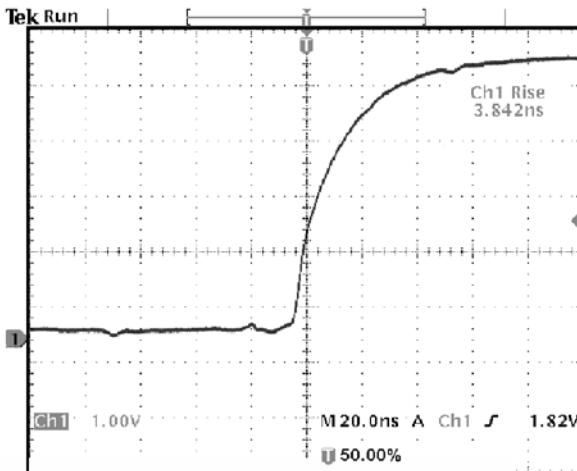

Measuring Specific Events. Next you want to see the pulses in the incoming digital signal, but the pulse widths vary so it is hard to establish a stable trigger. To look at a snapshot of the digital signal, do this step:

1. Push the **SINGLE SEQ** button to capture a single acquisition.

Now you want to measure the width of each displayed pulse. You can use measurement gating to select a specific pulse to measure. To measure the second pulse, for example, do these steps:

1. Push the **MEASURE** button.
2. Push the **CH 1** button and then push the **Select Measurement for Ch1** screen button.
3. Select the **Positive Width** measurement.
4. Push the **Gating** screen button.
5. Select **Gate With V Bar Cursors** to choose measurement gating using cursors.
6. Place one cursor to the left and one cursor to the right of the second pulse.

The oscilloscope shows the width measurement (160 ns) for the second pulse.

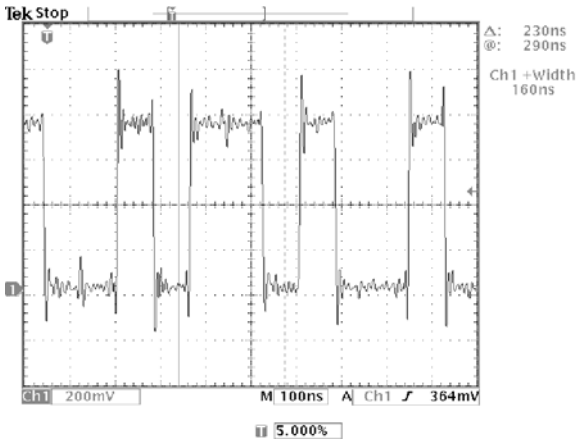

Analyzing Signal Detail

You have a noisy signal displayed on the oscilloscope and you need to know more about it. You suspect that the signal contains much more detail than you can now see in the display.

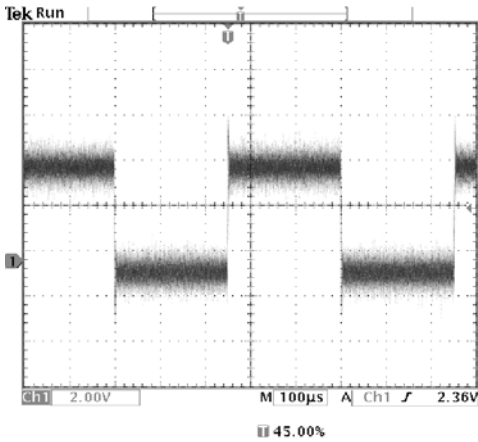

Looking at a Noisy Signal

The signal appears noisy and you suspect that noise is causing problems in your circuit. To better analyze the noise, do these steps:

1. Push the acquire **MENU** button.
2. Select the **Peak Detect** acquisition mode.
3. Increase the **WAVEFORM INTENSITY** control to see the noise more easily.

Peak detect emphasizes noise spikes and glitches in your signal as narrow as 1 ns, even when the time base is set to a slow setting.

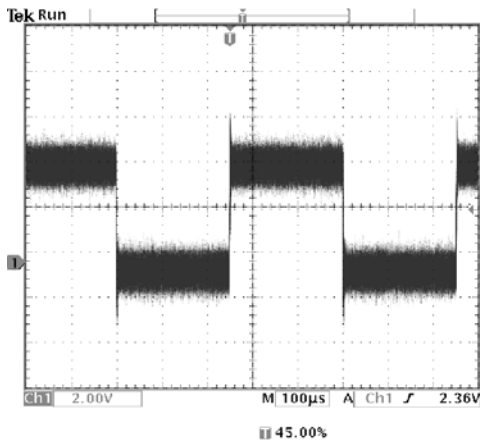

Refer to page 3-9 for more information about peak-detect and the other acquisition modes.

Separating the Signal from Noise

Now you want to analyze the signal shape and ignore the noise. To reduce random noise in the oscilloscope display, do these steps:

1. Push the acquire **MENU** button.
2. Push the **Mode** bottom button.
3. Select the **Average** acquisition mode.

Averaging reduces random noise and makes it easier to see detail in a signal. In the example below, a ring shows on the rising and falling edges of the signal when the noise is removed.

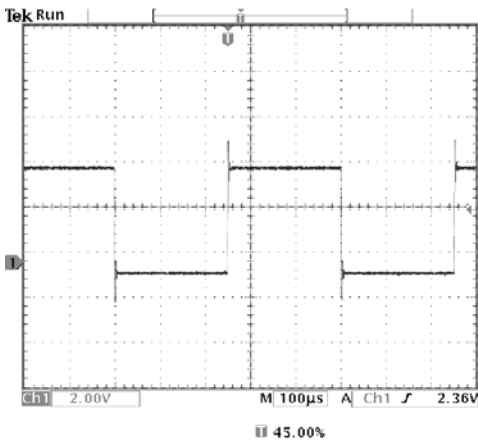

Taking Cursor Measurements

You can use the cursors to take quick measurements on a waveform. To measure the ring frequency at the rising edge of the signal, do these steps:

1. Push the **CURSOR** button.
2. Push the **Function** screen button.
3. Select **V Bars** cursors.
4. Push the **V Bar Units** screen button.
5. Select **1/seconds (Hz)**.
6. Place one cursor on the first peak of the ring using the general purpose knob.
7. Push the **SELECT** button.
8. Place the other cursor on the next peak of the ring.

The cursor Δ readout shows the measured ring frequency is 227 kHz.

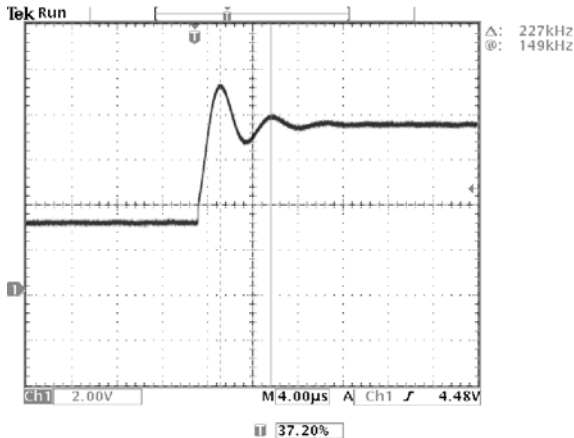

Using Delay

You are analyzing a pulse waveform and use the + Width measurement to measure the waveform pulse width. You notice that the measurement is not stable, which implies that there is jitter in the pulse width.

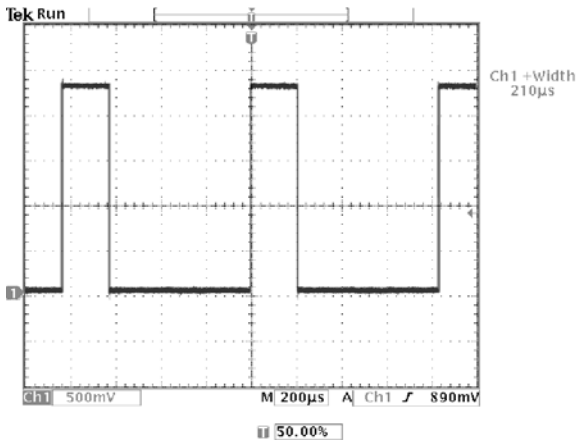

To use delay to see the jitter, do these steps:

1. Push the **DELAY** button.
2. Adjust the horizontal **POSITION** control to set the delay close to the nominal pulse width (210 µs). Push the **COARSE** button to make delay adjustments more quickly. Push **COARSE** again to fine tune the delay time.

The falling edge of the pulse is now near the center of the screen. When delay is on, the horizontal expansion point separates from the trigger point and remains in the center of the screen.

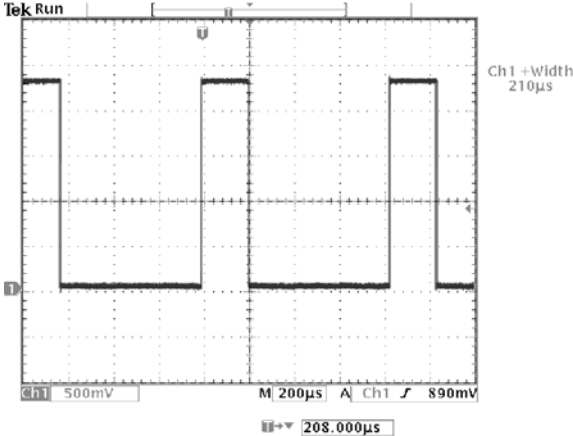

- 3. Adjust the horizontal **SCALE** to a faster time base setting and increase the **WAVEFORM INTENSITY** to see the jitter in the pulse width.

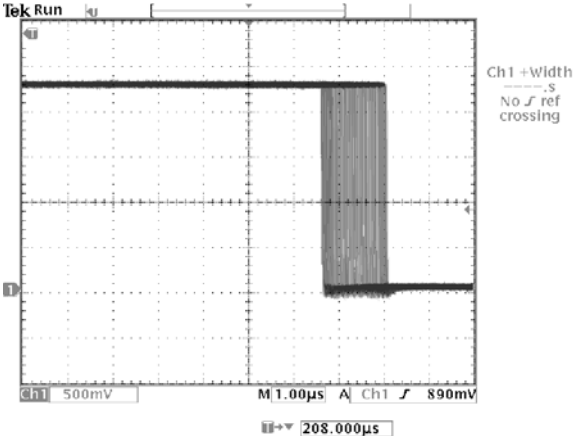

NOTE. You can toggle the delay function on and off to view signal details at two different areas of interest.

Measuring Jitter

To measure the peak-to-peak jitter, do these steps:

1. Push the **CURSOR** button.
2. Push the **Function** screen button.
3. Select the **V Bars** cursors.
4. Push the **Bring Both Cursors On Screen** screen button to quickly locate the cursors.
5. Place one cursor at the first falling edge and place the other cursor at the last falling edge.
6. Read the peak-to-peak jitter in the Δ readout ($1.40 \mu\text{s}$).

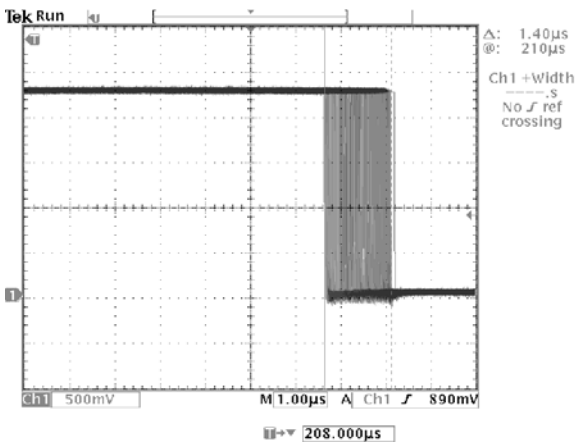

You can also measure the minimum and maximum pulse widths. When you select the first cursor, the $@$ readout displays the minimum pulse width ($210 \mu\text{s}$). When you select the second cursor, the $@$ readout displays the maximum pulse width ($211 \mu\text{s}$).

Triggering on a Video Signal

You are testing the video circuit in a piece of medical equipment and need to display the video output signal. The video output is an NTSC standard signal. Use the video trigger to obtain a stable display.

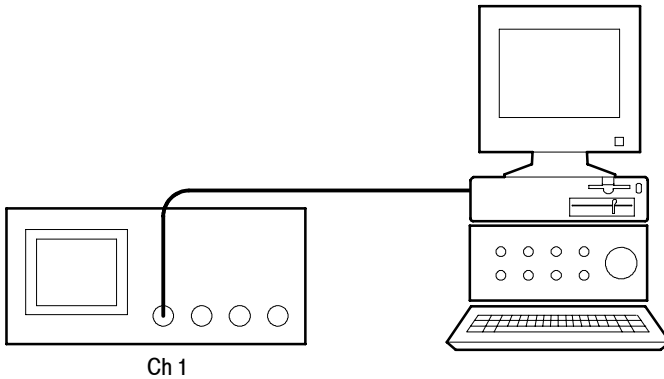

To trigger on the video fields, do these steps:

1. Push the trigger **MENU** button.
2. Push the **Type** screen button to select **Video**.
3. Push the **Standard** screen button to select **525/NTSC**.

4. Push the **Trigger On** screen button.
5. Select **Odd**.
6. Adjust the horizontal **SCALE** to see a complete field across the screen.
7. Push the acquire **MENU** button.
8. Push the **Resolution** screen button.
9. Select **Normal** acquisition resolution.

Normal acquisition resolution is the best choice to acquire a video field signal because the signal contains a great amount of horizontal detail.

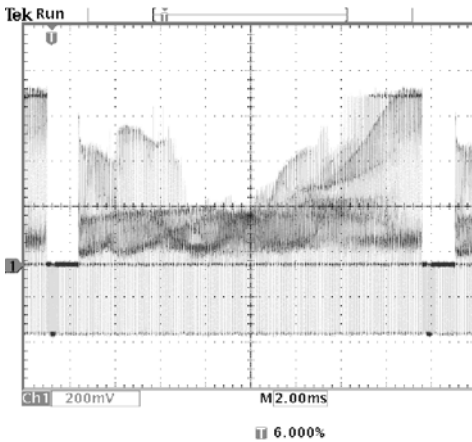

If the signal had been noninterlaced, you could choose to trigger on All Fields.

Triggering on Lines. You can also look at the video lines in the field. To trigger on the lines, do these steps:

1. Push the **Trigger On** screen button.
2. Select **All Lines**.
3. Adjust the horizontal **SCALE** to see a complete video line across the screen.

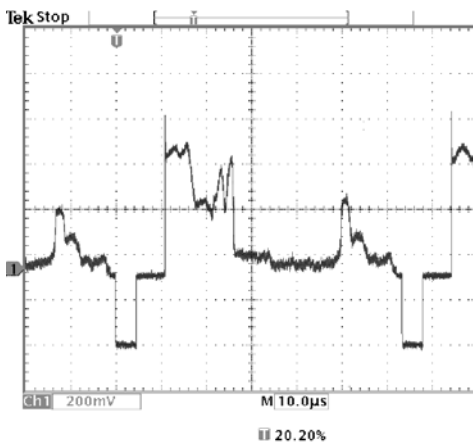

***NOTE.** The optional TDS3VID and TDS3SDI application modules add new video functions such as a video QuickMenu, video Autoset, trigger on custom scan rates, trigger on specific video lines, vectorscope (vectorscope supports component video only), video picture, trigger on analog HDTV signals, and view 601 digital video signals (TSD3SDI only).*

Looking at Modulation. A dedicated video waveform monitor clearly shows the modulation in a video signal. To see a similar modulation display on the oscilloscope screen, do these steps:

1. Start with triggered display of the video lines.
2. Push the acquire **MENU** button.
3. Push the **Resolution** screen button.
4. Select **Fast Trigger** acquisition resolution.
5. Adjust the **WAVEFORM INTENSITY** control for the amount of modulation you want to see.

The oscilloscope now shows signal modulation in shades of intensity and appears similar to the display of a video waveform monitor or an analog oscilloscope. Fast trigger acquisition resolution is the best choice to acquire a video line signal with a rapidly changing shape.

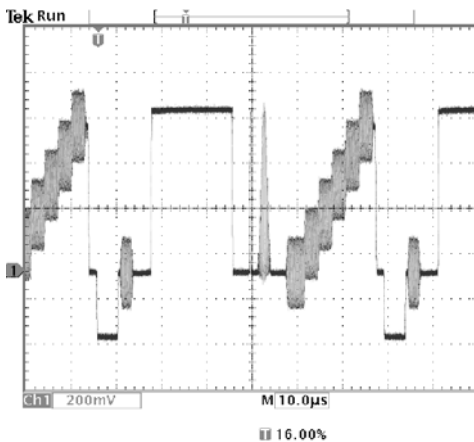

Capturing a Single-Shot Signal

The reliability of a reed relay in a piece of equipment has been poor and you need to investigate the problem. You suspect that the relay contacts arc when the relay opens. The fastest you can open and close the relay is about once per minute so you need to capture the voltage across the relay as a single-shot acquisition.

To set up for a single-shot acquisition, do these steps:

1. Adjust the vertical **SCALE** and horizontal **SCALE** to appropriate ranges for the signal you expect to see.
2. Push the acquire **MENU** button.
3. Push the **Resolution** screen button.
4. Select **Normal** acquisition resolution.
5. Push the **SINGLE SEQ** (single sequence) button.

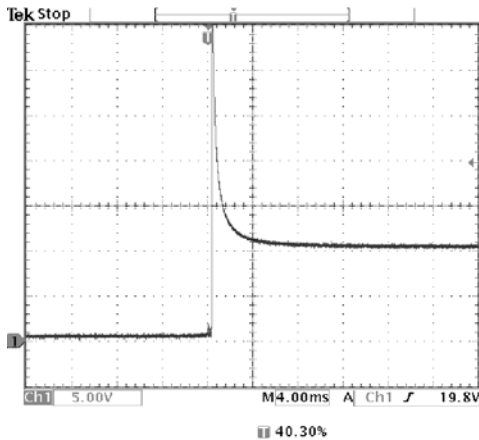

The **SINGLE SEQ** button sets trigger parameters to the correct settings for a single-shot acquisition.

Optimizing the Acquisition

The initial acquisition shows the relay contact beginning to open at the trigger point. This is followed by a large spikes that indicate contact bounce and inductance in the circuit. The inductance can cause contact arcing and premature relay failure.

Before you take the next acquisition, you can adjust the vertical and horizontal controls to give you a preview of how the next acquisition might appear. As you adjust these controls, the current acquisition is repositioned, expanded, or compressed. This preview is useful to optimize the settings before the next single-shot event is captured.

When next acquisition is captured with the new vertical and horizontal settings, you can see more detail about the relay contact opening. You can now see that the contact bounces several times as it opens.

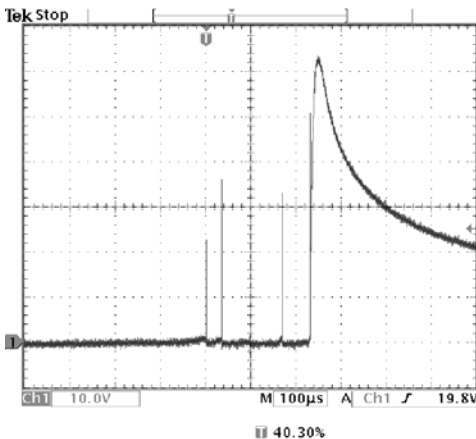

Using the Horizontal Zoom Function

If you want to take a close look at a particular spot on the acquired waveform, use the horizontal zoom function. To look closely at the point where the relay contact first begins to open, do these steps:

1. Push the zoom button  .
2. Use the horizontal **POSITION** to place the expansion point close to where the relay contact begins to open.
3. Adjust the horizontal **SCALE** to magnify the waveform around the expansion point.

The ragged waveform and the inductive load in the circuit suggest that the relay contact may be arcing as it opens.

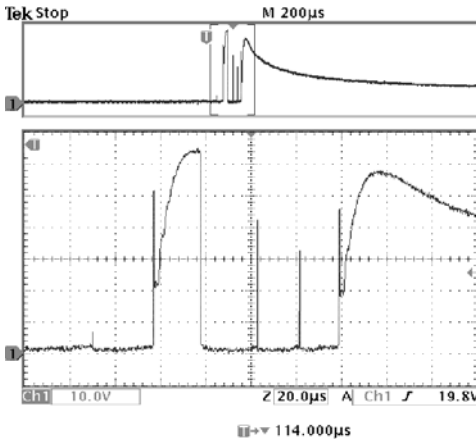

The zoom function works equally well when acquisition is running or is stopped. Horizontal position and scale changes affect only the display, not the next acquisition.

Saving Data to the Floppy Disk Drive

You need to do some work inside a remote site. You expect to use the oscilloscope to look at signal waveforms and then bring waveform information back to the office to complete a report and perform additional analysis. To do this, take along an IBM-compatible floppy disk.

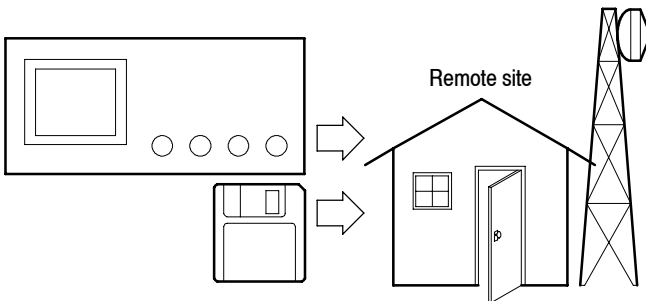

When you need to capture screen images, it may be most convenient to first save them to disk. Once on the disk, you can load the screen images into a PC, print hard copies with a printer attached to the oscilloscope or your PC, or import the screen images into desktop publishing software to produce a report.

You can also save waveform data on the disk. From the disk, you can recall waveforms to the oscilloscope display or you can import the data into spreadsheet and Mathcad software to perform additional analysis.

If you have oscilloscope setups that you want to use again, you also can store them on the disk. See *Save/Recall* on page 3-48 for more information on this capability. For information about remote control and network printing accessories, see *Appendix C: Accessories*.

Saving Screen Images

While working at the remote site you discover a control signal that you want to capture periodically to show its long-term variation. You want to include these waveforms in a report you are preparing back at the office.

Your desktop publishing software can import BMP graphics, so you decide to use this format for the screen images. To setup this configuration, do these steps:

1. Insert a floppy disk into the disk drive.
2. Push the **UTILITY** button.
3. Push the **System** screen button to select **Hard Copy**.
4. Push the **Format** screen button.
5. Select **BMP Windows mono image file format** (you may need to push the **-more-** screen button several times before you see this choice).
6. Push the **Port** screen button.
7. Select **File** to send hard copies to disk.
8. Push the hard copy button  to save the image.

The oscilloscope reads the disk directory and displays its contents.

Naming Files. It is good practice to give disk files descriptive names so you can recognize them when you get back to the office. You will be saving images of the control signal so you decide CNTRL is a logical target file name to use.

The oscilloscope can append an automatic sequence number to the target file name. This feature is convenient because you want to capture a screen image of the same control signal every five minutes. To set up the target file name and automatic sequence, do these steps:

1. Push the **File Utilities** screen button.
2. Use the general purpose knob to highlight the file **TEK?????.BMP**.
3. Select the **Rename** screen button.
4. Use the screen buttons to clear the existing file name and enter the new file name **CNTRL???.BMP**. The question marks are placeholders for an automatic number sequence from 000 to 999.
5. Push the **OK Accept** screen button to setup the target base file name.
6. Push **MENU OFF** to remove the file list from the display.

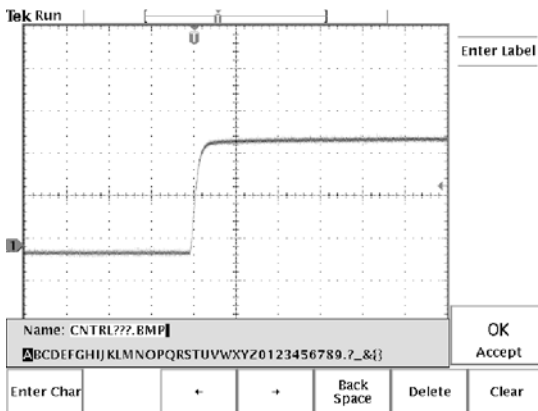

Running the Test. To capture the control signal every few minutes, do these steps:

1. Display the signal, measurements, and menus as you want them to appear in the screen images.
2. Push the hardcopy button  .
3. Repeat step 2 every few minutes until you are finished with the test.
4. When you are finished, push **UTILITY** to see the list of sequential files that have been saved.

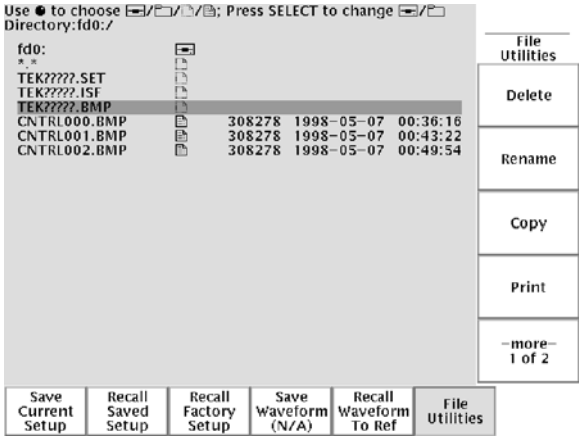

The files are labeled with their sequential names as well as the time and date each was created. You can save up to four BMP images or approximately 35 TIFF images on a single 1.44 MB floppy disk. You can also enable file compression (**UTILITY > System: Hard Copy > Options**) to compress files in zip format so that more files can fit on a floppy disk.

Saving Waveform Data

You find another signal that you want to analyze with a spreadsheet program back at the office. To save the waveform data on a disk, do these steps:

1. Display the signal on the oscilloscope screen.
2. Push the **SAVE/RECALL** button.
3. Push the **Save Wfm** screen button.
4. Select **To File**.
5. Select **Spreadsheet File Format**. The default target file, **TEK?????.CSV**, is now automatically highlighted.
6. Push the **Save To Selected File** screen button to save the waveform.
7. Push the **File Utilities** screen button to see the saved waveform file **TEK00000.CSV** in the disk directory.

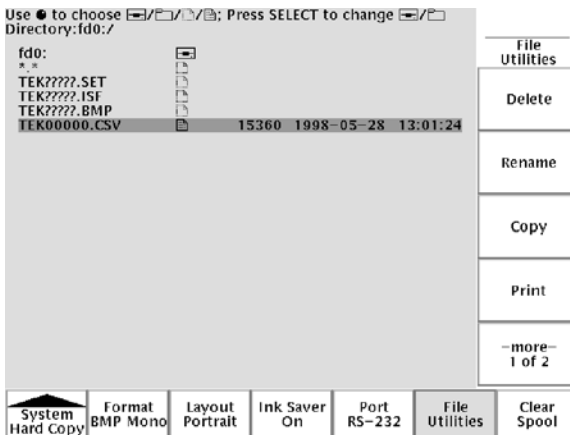



Reference

Introduction to Reference

This chapter contains detailed information about the operation of the oscilloscope. The topics in this chapter are arranged by front-panel button or control group name.

Reference topic	Page
Acquire	3-2
Cursor	3-16
Display	3-23
Hard copy	3-27
Horizontal controls	3-31
Measure	3-39
QuickMenu	3-47
Save/Recall	3-48
Trigger controls	3-58
Utility	3-70
Vertical controls	3-80
e*Scope	3-88

Acquisition Controls





Run/Stop Button

Push the RUN/STOP button to stop and start waveform acquisition. Also push RUN/STOP when you want to resume continuous acquisition after a single-sequence acquisition. Readout in the top left corner of the display shows the status of the acquisition.

Acquisition status readout	Description
Run:	Acquisition is running.
Roll:	A roll-mode acquisition is running.
Stop:	Acquisition is stopped.
PreVu:	Previewing; waiting for trigger.

While acquisition is running or stopped, you can use these controls to examine the waveforms:

- Channel buttons to select a channel
- Zoom button  with horizontal POSITION and SCALE to magnify waveforms (does not affect the actual time base or trigger position settings)
- WAVEFORM INTENSITY to adjust gray-scale level
- CURSOR button to activate cursors to measure waveforms
- MEASURE button to select automatic measurements of waveforms
- Hard copy button  to print a hard copy

While acquisition is stopped, you can change the vertical and horizontal controls to use in the next acquisition. See page 3-8 for more information about this function.

**SINGLE
SEQ**

Single Sequence Button

Push the SINGLE SEQ button to execute a single-shot acquisition. The function of the SINGLE SEQ button depends on the acquisition mode.

Acquisition mode	SINGLE SEQ function
Sample or Peak Detect	One acquisition of each displayed channel is acquired, concurrently
Envelope N or Average N	N acquisitions of each displayed channel are acquired (N is user adjustable with the general purpose knob)

When you push the SINGLE SEQ button, the oscilloscope does the following things:

- The trigger mode is set to Normal
- The trigger system arms and the light next to the SINGLE SEQ button turns on

After the single-sequence acquisition is complete, acquisition stops and the light next to the SINGLE SEQ button turns off.

Push the SINGLE SEQ button again to acquire a new sequence, or push the RUN/STOP button to restart continuous acquisition.



Autoset Button

Push the AUTOSSET button to automatically adjust the vertical, horizontal, and trigger controls for a usable display. You can manually adjust any of these controls if you need to optimize the display.

When you are using more than one channel, the autoset function sets the vertical scale for each channel and positions the channels to prevent overlapping. The autoset function selects the lowest-numbered channel in use and then uses that channel to set the horizontal and trigger controls.

The autoset function also changes the following oscilloscope settings:

- Acquisition mode is set to Sample
- Bandwidth limits are set to Full
- Zoom is turned off
- Trigger is set to Auto mode and minimum holdoff
- Trigger is set to Edge type, DC coupling, and rising slope
- B trigger is turned off
- XY display format is turned off
- Channel 1 is turned on and selected if no active channels are in use

If you push the AUTOSSET button by accident, you can undo it with these steps:

1. Push the Acquire **MENU** button.
2. Push the **Autoset** screen button and then push the **Undo Autoset** screen button.



Waveform Intensity

The WAVEFORM INTENSITY adjusts the intensity of the waveforms in the display.

The term Digital Phosphor represents the way this control simulates the intensity control of an analog oscilloscope. At maximum intensity, all waveform points are displayed at full brightness. As you decrease the intensity, you can see intensity grading in the waveforms. The brightest parts of the waveform are the points most frequently acquired; the dimmer parts represent less frequently acquired points. All points decay in intensity over time unless the display persistence is set to infinite.

Use a medium intensity setting to get an analog-oscilloscope view of time-varying signals and those containing modulation. Use the maximum intensity setting to view the signals the way most digital oscilloscopes display them.

You can turn on display persistence to slow or prevent the decay of the waveform points. With persistence on, you can simulate the function of an analog storage oscilloscope. See page 3-23 for more information about display persistence.

NOTE. *The waveform intensity may change when you change oscilloscope acquisition modes or horizontal scale settings. Use the INTENSITY knob to readjust waveform intensity.*

Acquire Menu

Push the Acquire MENU button to show the acquire menu.

MENU

Bottom	Side	Description
Mode	Sample	Use for normal acquisition.
	Peak Detect	Detects glitches and reduces the possibility of aliasing.
	Envelope N	Captures variations of a signal over a period of time. (Adjust N with the general purpose knob.)
	Average N	Reduces random or uncorrelated noise in the signal display. (Adjust N with the general purpose knob.)
Horizontal Resolution	Fast Trigger (500 points)	Acquires 500 point waveforms at a fast repetition rate.
	Normal (10k points)	Acquires 10,000 point waveforms with more horizontal detail.
Reset Horizontal Delay	Set to 0 s	Resets the horizontal delay time to zero.
Autoset	Normal Autoset	Executes the autoset function. (Optional application modules may add choices to execute specialized autoset functions.)
	Undo Autoset	Reverts to the settings before the last autoset.

Bottom	Side	Description
WaveAlert	Wfm Anomaly Detection On Off	Enables or disables the WaveAlert function. See page 3-13 for an explanation of WaveAlert.
	Sensitivity nn.n%	Sets the WaveAlert sensitivity. Use the general purpose knob to set sensitivity from 0% (least sensitive) to 100% (most sensitive).
	Beep On Anomaly On Off	When On, the oscilloscope beeps when it detects a waveform anomaly on any active channel.
	Stop On Anomaly On Off	When On, the oscilloscope stops waveform acquisition when there is a waveform anomaly on any channel. The input waveforms and anomalies remain displayed on the screen.
	Hard Copy On Anomaly On Off	When On, the oscilloscope sends an image of the screen to the hard copy device or floppy file when there is a waveform anomaly on any channel.
	Wfms to Disk On Anomaly On Off	When On, the oscilloscope saves the anomalous waveform(s) data to a file on the floppy disk drive.
	Highlight Entire Wfm	Highlights the entire anomalous waveform.
	Highlight Anomalies	Highlights just the anomalous data in a waveform.

Key Points

Vertical and Horizontal Preview. The vertical and horizontal preview functions let you change the vertical and horizontal controls while acquisition is stopped or while it is waiting for the next trigger. The oscilloscope rescales and repositions the current acquisition in response to the new control settings, and then uses the new settings for the next acquisition.

Preview helps you optimize these control settings before the next acquisition; this makes it easier to work with signals that are single-shot or have a low repetition rate.

- For more information about vertical preview, see page 3-83.
- For more information about horizontal preview, see page 3-36.

While acquisition is stopped you can make changes to other controls, but those changes will only take effect with the next acquisition. There is no preview for control changes other than the vertical and horizontal controls.

The preview functions also do not affect automatic measurements, cursor measurements, or the Math waveform. This data for these functions is always based on the current acquisition. If you rescale or reposition a channel waveform horizontally, it may not appear time-correlated to the automatic measurements, cursor measurements, or the Math waveform.

Acquisition Modes. You can choose one of four acquisition modes: Sample, Peak Detect, Envelope, or Average. The next two pages describe these acquisition modes in detail.

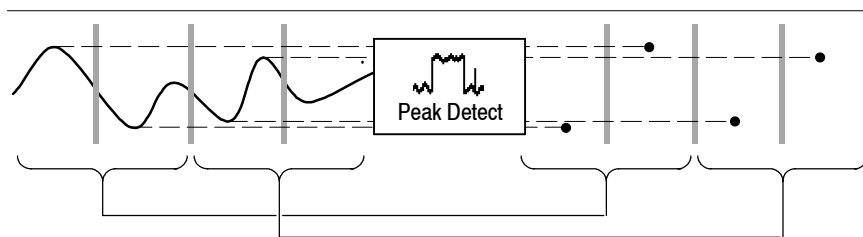
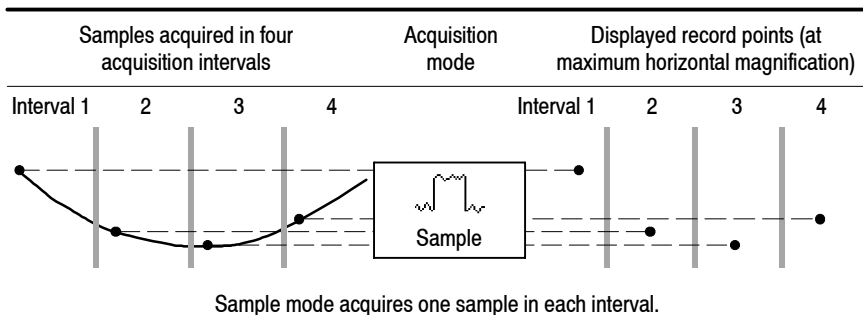

Sample. Use Sample acquisition mode for the fastest acquisition at any SEC/DIV setting. Sample mode is the default mode.

Peak Detect. Use Peak Detect acquisition mode to limit the possibility of aliasing. Also, use Peak Detect for glitch detection. You can see glitches as narrow as 1 ns.

Peak Detect is only functional for sample rates up to 125 MS/s. For 250 MS/s and faster sample rates, the oscilloscope reverts to Sample acquisition mode, where the narrowest detectable pulse width is $1/(\text{sample rate})$.

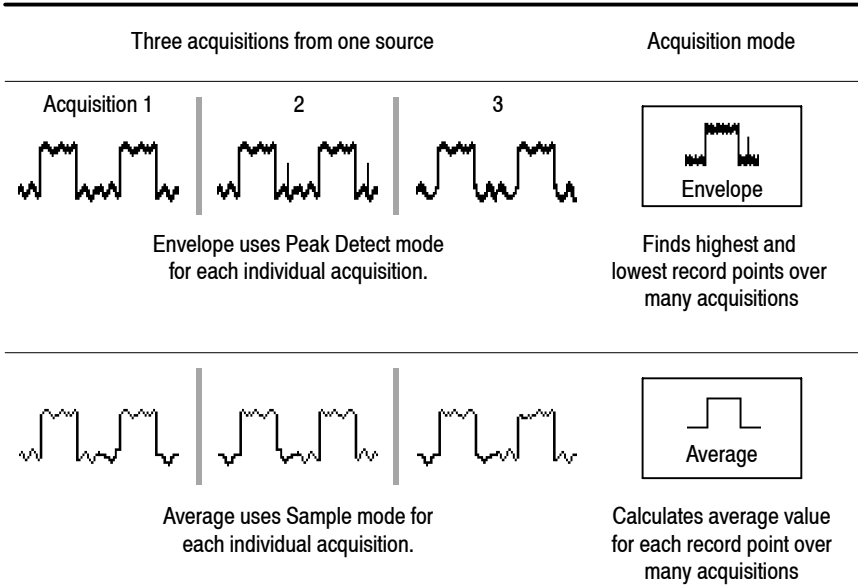

Envelope. Use Envelope acquisition mode to capture the minimum and maximum extremes of a signal over a specified number of acquisitions (N). The enveloped waveform data acquisition clears and then starts over after each N acquisitions. If you push the SINGLE SEQ button, envelope acquisition stops after N acquisitions. Use the general purpose knob to set the number of acquisitions.

Average. Use Average acquisition mode to reduce random or uncorrelated noise in the signal you want to display. The averaged waveform is a running average over a specified number of acquisitions (N). If you push the SINGLE SEQ button, average acquisition stops after N acquisitions. Use the general purpose knob to set the number of acquisitions.

If you probe a noisy square wave signal that contains intermittent, narrow glitches, the waveform displayed will vary depending on the acquisition mode you choose.

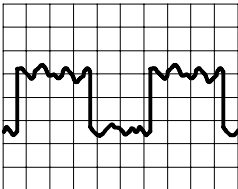

Sample



Peak Detect

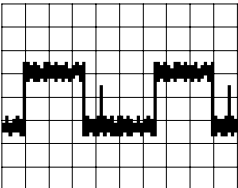

Envelope

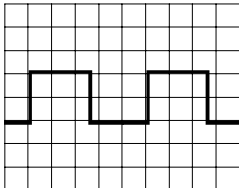

Average

Acquisition Resolution. You can choose either Normal or Fast Trigger acquisition resolution. This setting determines the record length that is acquired and affects the other factors shown in the table below.

Factor	Normal	Fast trigger
Record length	10,000 points	500 points
Maximum acquisition rate: 300 MHz - 600 MHz models 100 MHz - 200 MHz models	700 waveforms/s 400 waveforms/s	3,600 waveforms/s 3,600 waveforms/s
Maximum horizontal zoom factor	200X	10X

Choose Normal or Fast Trigger acquisition resolution based on the characteristics of the signal you want to acquire.

Signal characteristic	Better choice
Large amount of horizontal detail	Normal
Shape is stable or changes relatively slowly	Normal
Single shot	Normal
High trigger repetition rate	Fast Trigger
Shape changes rapidly	Fast Trigger
Contains modulation	Fast Trigger

WaveAlert™ Waveform Anomaly Detection. WaveAlert provides a way to detect when a waveform deviates from a steady-state condition. WaveAlert monitors the current waveform acquisition and compares it to the previous DPO waveform acquisitions, using a sensitivity value to adjust the comparison tolerance. If the current acquisition exceeds the comparison tolerance, the oscilloscope considers the current acquisition as an anomaly.

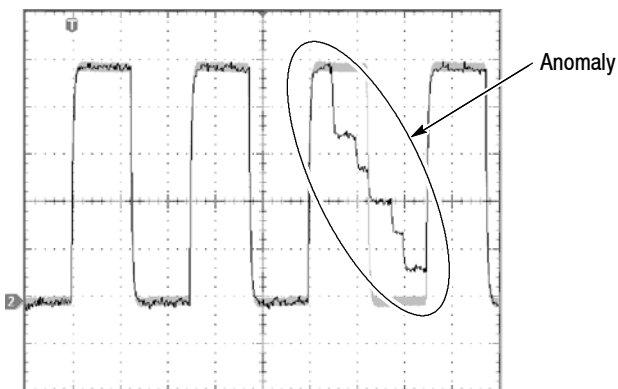

The oscilloscope can respond to an anomalous waveform by stopping acquisitions, emitting a beep, saving the anomalous waveform to a disk file, printing the screen image to a hard copy device, or any combination of the above. You can also select to highlight just the anomalous data in a waveform, or the entire anomalous waveform.

To use WaveAlert, do the following steps:

1. Display the waveform or waveforms on the screen.
2. Push the Acquire **MENU** front-panel button.
3. Push the **WaveAlert** bottom menu button.
4. Push the **Wfm Anomaly Detection** side button to select **On**.
5. Push the **Highlight Anomalies** side button to select **On**.
6. Use the general purpose knob to set the comparison sensitivity value. As signal noise and intensity levels affect the displayed waveform, you will need to experiment with the sensitivity setting to reduce the number of false anomalies due to signal noise.
7. Use the **WAVEFORM INTENSITY** front-panel button to adjust the persistence of the anomaly waveform.
8. Once you have set the sensitivity value to reduce or eliminate false anomalies, push one or more side menu buttons to select the actions to perform when the oscilloscope detects an anomaly.
9. To restart WaveAlert while in **Stop On Anomaly**, push the Acquire **RUN/STOP** front panel button.

WaveAlert Key Points.

- You can use WaveAlert to monitor up to four waveforms or DPO Math waveforms. However, adjacent waveforms can not touch or overlap on the screen.
- To increase your chances of capturing an anomaly by acquiring the maximum number of waveforms per second, set **ACQUIRE > Horizontal Resolution to Fast Trigger** (500 points).
- When WaveAlert is on, the front-panel **WAVEFORM INTENSITY** knob controls the persistence of the anomalous waveform instead of waveform intensity.
- To capture a very random event (minutes to hours), enable the **Wfms to Disk on Anomaly** function to write anomalous waveform data to a disk file in .isf format. The number of files you can save depends on the waveform record length. You can determine when the anomaly occurred by checking the file create date and time.
- You can use WaveAlert on DPO math waveforms.
- Changing the vertical or horizontal oscilloscope settings does not affect the sensitivity setting. The sensitivity is calculated from the new waveform data after changing the oscilloscope settings.

Cursor

Cursors are on-screen markers that you position to take waveform measurements. There are two cursor types: YT cursors and XY cursors. The following section describes the YT cursors. Refer to page 3-21 for information on XY cursors.

YT Cursor Menu

The following YT cursor menu items are available while you are in YT display mode (**DISPLAY > XY Display > Off(YT)**). Push the CURSOR button to show the cursor menu.



Bottom	Side	Description
Function	Off	Turns cursors off.
	H Bars	Use to make vertical measurements.
	V Bars	Use to make both vertical and horizontal measurements.
	Bring Selected Cursor to Center Screen	Moves the active cursor to center screen.
	Bring Both Cursors On Screen	Moves any off-screen cursor onto the screen.
Mode	Independent	Sets cursors to move independently.
	Tracking	Sets cursors to move together when cursor 1 is selected.

Bottom	Side	Description
V Bar Units	Sec (s) / 1/sec (Hz)	Sets horizontal units to seconds or frequency (Hz).
	Ratio (%)	Sets V Bar measurement units to percent.
	Phase (°)	Sets V Bar measurement units to degrees.
	Use Cursor Positions as %/°	Sets the V Bar measurement scale so that 0% or 0° is the current position of the left V Bar cursor and 100% or 360° is the current position of the right V Bar cursor.
	Use 5 divs as %/°	Sets the V Bar measurement scale so that 5 screen major divisions is 100% or 360°, where 0% or 0° is -2.5 divisions and 100% or 360° is +2.5 divisions from center vertical graticule.

Bottom	Side	Description
H Bar Units	Base	Sets the H Bar units to be the same as the selected waveform's vertical measurement units (volts, IRE, dB, and so on).
	Ratio (%)	Sets H Bar units to percent.
	Use Cursor Positions as 100%	Sets the H Bar measurement scale so that 0% is the current position of the lowest H Bar cursor and 100% is the current position of the highest H Bar cursor.
	Use 5 divs as 100%	Sets H Bar measurement scale so that 5 screen major divisions is 100%, where 0% is -2.5 divisions and 100% is +2.5 divisions from the center horizontal graticule.

Key Points

Cursor Movement. Use the general purpose knob to move the active cursor. Push the SELECT button to change which cursor is active. The active cursor is the solid line.

Faster Cursor Movement. Push COARSE to set the general purpose knob to make faster cursor movement.

Finding Cursors. When using zoom, delay, or the fastest time base settings, the cursors can go off screen. If you want to find them, use the Bring Both Cursors On Screen function to move them onto the screen.

Fine Cursor Movement. When you magnify the waveform with the zoom function, you can easily set the cursor to any point on the waveform.

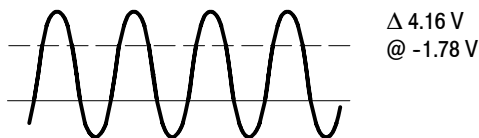

Horizontal Bar cursors

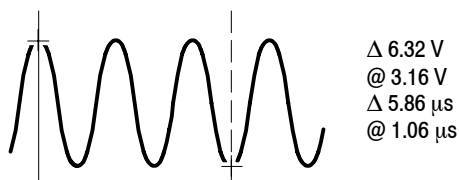

Vertical Bar cursors

Δ Readout. The Δ readouts indicate the difference between the cursor positions.

@ Readout. For H Bar or V Bar cursors, the voltage readout after the @ symbol indicates the location of the active cursor relative to zero volts. For V Bar cursors, the time readout after the @ symbol indicates the location of the active cursor relative to the trigger point.

Cursor Interaction with Preview. If you change a vertical or horizontal control setting while acquisition is stopped or it is waiting for trigger, the cursors move with the waveforms and cursor measurements remain valid.

Taking Gray-Scale Measurements. Using cursors is often the best way to take simple measurements on waveforms that contain significant gray-scale information. The automatic measurements operate only on the latest acquisition, not on the previous acquisitions that are displayed in gray scale. However, you can set the cursors to surround and measure the gray-scale area of the waveform.

Cursors at Same Position. If both cursors are at the same position, and H Bars or V Bars are set to Ratio or Phase, both cursors are set to 0% (or 0°). 100%/360° is set to one pixel width away from the cursor position.

V Bars and FFT. When the selected waveform is an FFT waveform, selecting V Bars and Phase sets the measurement to percent.

Tracking Mode. In cursor tracking mode, both cursors move together when cursor 1 is selected. Enabling tracking mode automatically selects cursor 1 as the active cursor. If cursor 2 is selected while in tracking mode, only cursor 2 will move.

XY Cursor Menu

The following XY cursor menu items are available while you are in XY display mode (**DISPLAY > XY Display > Triggered XY**). Push the **CURSOR** button to show the cursor menu.

CURSOR



	Bottom	Side	Description
Function		Off	Turns cursors off.
		Waveform	Turns waveform cursors on and displays measurements in rectangular format (X and Y values). Use the front-panel SELECT button to select which cursor to move (the active cursor). Use the general purpose knob to move the active cursor.
Mode		Independent	Sets cursors to move independently.
		Tracking	Sets cursors to move together when the reference cursor is selected.

NOTE. The Advanced Analysis application module (TDS3AAM) adds more XY cursor features, including graticule cursors and polar readouts.

Key Points

XY Waveform Cursors.

To turn off the XY waveform cursor measurement, push the front panel **CURSOR** button, then push the Cursor Function **Off** side menu button.

Measurements. The XY waveform cursor measurements show difference (Δ) and absolute (@) values for the X axis, the Y axis, and the time of the active cursor.

ΔX : 1.43V @X: -140mV

ΔY : 2.14V @Y: 480mV

Δt : -660ns @t: 1.61ms

There are two waveform cursors; a reference cursor (\boxplus), and a delta cursor (\oplus). All difference (Δ) measurements are measured from the reference cursor to the delta cursor. A negative ΔX measurement means that the delta cursor is positioned earlier in the waveform record than the reference cursor. A negative ΔY measurement means that the delta cursor is positioned at a lower Y waveform signal level than the reference cursor.

All absolute (@) measurements are referenced to the XY waveform's 0, 0 origin, and show the value of the active cursor.

0, 0 Origin. The XY waveform origin is the 0 volt point of each source waveform. Positioning both source waveform 0 volt points on the vertical center graticule places the origin in the center of the screen.

Switching Between XY and YT. You can switch between XY and YT display mode to see the location of the cursors in the YT waveform. The waveform record icon at the top of the graticule also shows the relative cursor positions in the waveform record.

Waveform Sources. You can use XY cursors on active acquisitions, single sequence acquisitions, and reference waveforms. You need to store both XY source waveforms in order to recreate an XY waveform. The X axis waveform must be stored in Ref1.

Display

Push the DISPLAY button to show the display menu.

DISPLAY



Bottom	Side	Description
Waveform Display	Dots Only	Set to on to see dots only. Set to off to see dots and vectors.
	Persist Time	Sets persist time.
	Set to Auto	Sets the WAVEFORM INTENSITY knob to control the persistence time.
	Clear Persistence	Clears any displayed persistence.
Backlight Intensity	High	Use for bright ambient conditions.
	Medium	Use for dim ambient conditions.
	Low	Use to extend battery-operation time.
Graticule	Full, Grid, Cross Hair, Frame	Sets the graticule type.

Bottom	Side	Description
XY Display	Off (YT)	Turns off an XY display.
	Triggered XY	Turns on triggered XY display.
	Gated XYZ	Turns on gated XY display. Displays XY signals when Z-channel signal is above a set level. Only available on 4-channel instruments.
	Ch1 (X) Versus	Sets Ch2, Ch3, or Ch4 as the Y channel versus Ch1 as X.
	Ref1 (X) Versus or Gated By	Sets Ref2, Ref3, or Ref4 as the Y channel versus Ref1 as X. Sets Ch2, Ch3, or Ch4 as the Z-channel gate source, and sets the gating channel threshold level.
Color Palette	Normal	Selects the color display.
	Monochrome	Sets all waveforms to high-contrast black and white.

Key Points

Waveform Dots and Vectors. With Dots Only set to off, the vectors between samples can be filled; increase the WAVEFORM INTENSITY control to increase the amount of vector fill between samples. The vector fill is most visible on fast signal edges or when horizontal zoom  is turned on.

Turn Dots Only on if you want to see just the actual samples.

Waveform Persistence. Turn on waveform persistence to slow the decay of waveform points. You can set the persistence to a specific time or to infinite. Infinite persistence keeps all waveform points in the display until you change a control setting that erases the display.

Display Colors. The channel buttons, waveforms, icons, and readouts are color-coded to help you identify them easily. The colors are preset and cannot be adjusted. However, you can select the Monochrome Color Palette if you prefer to see all the waveforms in high-contrast black and white.

XY Waveform Triggering. The XY waveform is triggered so you can synchronize periodic input signals to the XY waveform. This feature is useful when only one part of the period contains valid information that you want to see in the XY format. Set the time base and trigger location to acquire just that part of the period.

When you want to see the complete period of the signals regardless of the time base setting, set the trigger source to an unused channel and the trigger mode to Auto.

XY Waveform Scale and Position. If you want to display channel 1 in the horizontal axis versus channel 3 in the vertical axis, for example, use these controls to scale and position the XY waveform:

- Push the CH 1 button and use the vertical SCALE and POSITION controls to set the horizontal scale and position of the XY waveform.
- Push the CH 3 button and use the vertical SCALE and POSITION controls to set the vertical scale and position of the XY waveform.

XY Waveform Restrictions. The math waveform, zoom, and autoset functions do not work in the XY display format. All reference waveforms displayed in XY format must have the same record length (500 or 10,000 points).

Gated XYZ. Displays XY signals only when the Z (gating) channel is true. Gated XYZ is similar to analog oscilloscope modulated XYZ mode except that the displayed XY signal is either on or off; there is no intensity modulation. Gated XYZ is useful for showing constellation diagrams.

Push the Gated By screen button to select the Z (gate) source channel.

The general purpose knob sets the Z-channel threshold level. Z-channel signals above the set threshold are true and open the XY signal gate; Z-channel signals below the set threshold are false and close the XY signal gate. The gating channel is always a high-true logic; to emulate a low-true gating logic, use the vertical menu to invert the Z-channel signal.

XY and XYZ Cursors. Refer to page 3-21 for information on XY and XYZ cursor readouts.

Hard Copy



Push the hard copy button at the left of the display to make a hard copy. You can also store hard-copy images on a floppy disk (in normal or compressed format) and then transfer them later to a PC for printing or use in a report.

Connecting a Printer

Use the rear-panel RS-232 or GPIB (available on optional communication modules), Centronics, or Ethernet port to connect your oscilloscope to a printer.

Setting Up to Print

Follow these steps to set up the oscilloscope to print a hard copy:

1. Push the **UTILITY** menu button.
2. Push the **System** screen button to select **Hard Copy**.
3. Push the **Format** screen button and then choose the printer format appropriate for your application.
4. Push the **Options** screen button to select the image orientation (portrait or landscape) as well as turn on or off hard copy file compression.
5. Push the **Ink Saver** screen button and select **On** for most applications. If you want the hard copy colors to be the same as the screen colors, you can select **Off** (see page 3-29).
6. Push the **Port** screen button and select the port that your printer is connected to, or select **File** to save the hard copy on a floppy disk (see page 3-52).
7. Push the hard copy button .

Key Points

Printer Formats. The oscilloscope supports the following printers and file formats.

Format	Description
TDS3PRT	Tektronix plug-in thermal printer
Thinkjet	HP monochrome ink-jet printer
Deskjet mono	HP monochrome ink-jet printer
Deskjet color	HP color inkjet printer
Laserjet	HP monochrome laser printer
Epson	Epson 9-pin and 24-pin dot matrix printers, C60 and C80 inkjet printers
Interleaf	*.img Interleaf image object file format
TIFF	*.tif Tag image file format
RLE color	Windows color image file format
PCX mono	PC Paintbrush monochrome image file format
PCX color	PC Paintbrush color image file format
BMP mono	Windows monochrome image file format
BMP color	Windows color image file format
EPS mono	Encapsulated PostScript monochrome image
EPS color	Encapsulated PostScript color image
Bubble Jet	Canon BJC-50, BJC-80 color printers
DPU-3445	Seiko DPU-3445 thermal printer
PNG color	Portable Network Graphics color image

Hard Copy File Compression. When compression is set to on, the oscilloscope compresses the hard copy data, using the current printer format, into a gunzip file format, with the extension .gz. Compressing hard copy files lets you store more screen captures on a floppy disk. Centronics output is never compressed. .gz files can be decompressed using PKZIP™ or WinZip™ programs.

Color and Gray-Scale Printing. You can print a color hard copy that uses the display colors. Gray-scale waveform information is printed as shades of color. If you have a Deskjet or Laserjet monochrome printer, gray-scale waveform information is printed as a dithered image.

Ink Saver and Preview. As an alternative to printing the display colors, turn on the Ink Saver function to print a hard copy with a white background. This function saves printer ink while it preserves the color coding of the waveforms and readouts, except for channel 1. Because yellow ink is hard to see on white paper, Ink Saver prints channel 1 using a dark blue ink. Ink saver also works with the monochrome print formats.

Push and hold the Preview screen button to show how the colors will appear on the paper.

Clear Spool. You can push the Clear Spool screen button to empty the print spooler to stop a hard copy operation in progress, if the hard copy port connection is not made due to incompatible settings (such as baud rate), or if you lose the hard copy port connection before the hard copy is complete.

Date and Time Stamp. To print the current date and time on your hard copies, do these steps:

1. Push the **UTILITY** button.
2. Push the **System** screen button to select **Config**.
3. Push the **Set Date & Time** screen button.
4. Set the **Display Date/Time** to **On** to add the current date and time to the display screen.
5. Push the **Menu Off** button.
6. Push the hard copy button  .

Printer Error Message. To avoid printer errors, always power on the printer and allow it to complete its initialization process before powering on the oscilloscope. If you see a 'Hard copy device not responding' error message, power the oscilloscope off and then back on, and then try printing again. If the printer still does not work, check that the printer is online, you have selected the correct printer format on the oscilloscope, there are no paper jams, and that the printer cable is firmly connected to the printer and oscilloscope.

Horizontal Controls

Use the horizontal controls to adjust the time base, adjust the trigger location, and to examine waveform details more closely.



Horizontal Position Control

When delay is off, the horizontal POSITION control moves the trigger point within the acquired waveforms. You can select full pretrigger, full posttrigger, or any point in between.

Use a pretrigger setting (trigger position near 100% of the record) to acquire waveforms leading up to a trigger event. For example, if you can trigger on an error condition, the waveforms leading up to the error condition might tell you why the error occurred.

Use a posttrigger setting (trigger position near 0% of the record) when you want to acquire waveforms that follow a trigger event. Use a mid-screen setting when you are interested in information both before and after the trigger event.

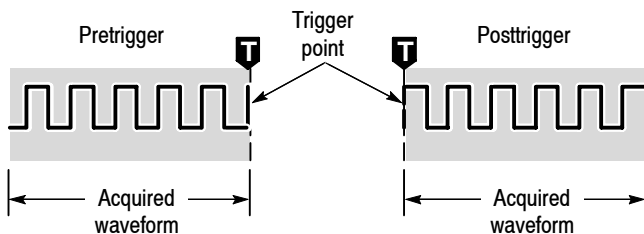

See *Delay Button* on page 3-33 and *Zoom Button* on page 3-35 for information about how the horizontal POSITION control operates when these functions are active.

The trigger position is marked with the letter T at the top of the graticule and also in the waveform record icon at the top of the screen.

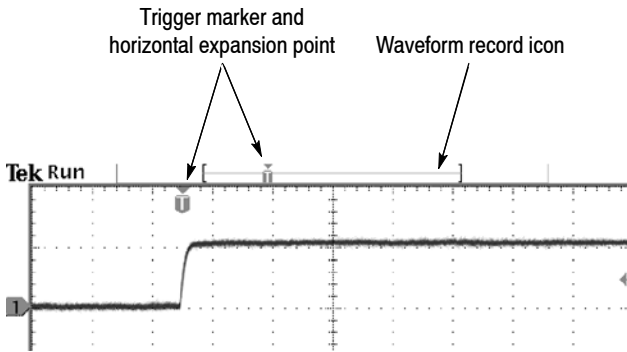

The small inverted triangle is the horizontal expansion point. When you change the horizontal SCALE setting, the waveforms contract or expand about this point. When delay is off, the horizontal expansion point is the same as the trigger point.

DELAY**Delay Button**

Push the DELAY button when you want to delay the acquisition relative to the trigger event. Turn the horizontal POSITION control counterclockwise to increase the delay; the trigger point moves to the left and ultimately outside of the acquired waveform. Then, you can adjust the horizontal SCALE to acquire more detail around the area of interest (center of the screen).

When delay is on, the trigger point separates from the horizontal expansion point. The horizontal expansion point stays at the center of the screen. The trigger point can move off the screen; when this happens, the trigger marker turns to point in the direction of the trigger point.

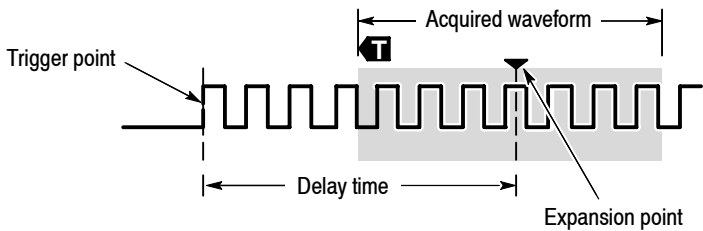

Use the delay feature when you want to acquire waveform detail that is separated from the trigger event by a significant interval of time. For example, you can trigger on a sync pulse that occurs once every 10 ms and then look at high-speed signal characteristics that occur 6 ms after the sync pulse.

In the screen example below, the trigger markers show that the trigger point is before the acquired waveform. The delay time, shown in the readout, is the time from the trigger point to the expansion point (center screen).

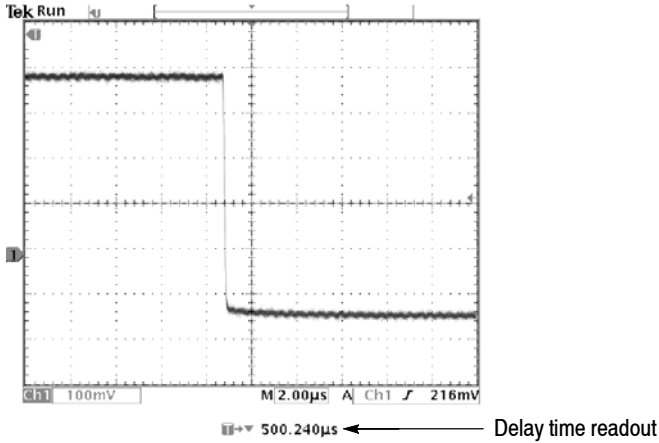

The interaction between delay and other functions is summarized in the table below.

Function	Delay off	Delay on
Trigger point	Any point within the acquired waveform	Can occur prior to the acquired waveform
Expansion point	Same as the trigger point	Always center screen
Horizontal SCALE	Sets time base	Sets time base
Horizontal POSITION	Sets trigger position in the acquired waveform	Sets delay time



Horizontal Scale Control

Use the horizontal SCALE control to adjust the time base. When delay is off, the scale expands or contracts around the trigger point. When delay is on, the scale expands or contracts around the center of the screen (see *Delay Interactions* on page 3-38 for possible exceptions).

When the zoom function is active, use the horizontal SCALE control to adjust the amount of horizontal magnification (the actual time-base setting remains unchanged). The magnified waveforms always expand or contract around the center of the screen.



Zoom Button

Push the zoom button to magnify the current acquisition along the horizontal axis so you can see more detail. Use the horizontal SCALE control to adjust the amount of magnification. Use the horizontal POSITION control to select the portion of the waveform you want to magnify. When zoom is on, changes you make to these controls do not affect the actual time base or trigger position settings.

The split screen shows the entire selected waveform in the upper window to give you a point of reference as you examine the details in the lower window.

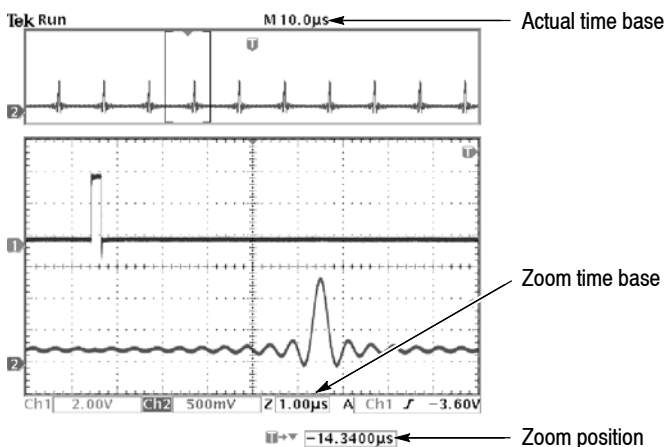

Key Points

Maximum Zoom Magnification Factor. If you are using Normal acquisition resolution, the maximum horizontal magnification factor is 200X; in Fast-trigger the maximum is 10X.

Horizontal Zoom and Preview. There are two ways you can magnify a stopped acquisition, horizontal zoom or preview. The differences in how horizontal zoom and preview interact with other functions are shown below.

Function	Horizontal zoom	Horizontal preview
Horizontal SCALE	Sets magnification factor	Changes time base for the next acquisition
Horizontal POSITION	Selects portion of waveform to magnify	Changes trigger position or delay time for the next acquisition
DELAY button	Turns delay on and off	Turns delay on and off
Math waveform	Remains valid; magnifies and positions with other waveforms	Remains fixed; does not track changes to channel waveforms
Cursors and automatic measurements	Remain functional with valid readouts	Remain locked to channel waveforms
Gray-scale	Gray-scale information may be temporarily reduced	Gray-scale information is lost

Slow Horizontal Settings. At horizontal SCALE settings of 40 ms/div or slower, the oscilloscope may display waveforms in roll mode. As the rolling waveform fills the screen, the waveform intensity and vector fill appears to decrease. The oscilloscope automatically reduces the number of displayed points in order to maintain a high acquisition rate: this does not represent a loss of acquired data.

When you stop the acquisition, the original waveform intensity and vector fill returns to the display.

Using Zoom and Delay Together. You can use both zoom and delay at the same time to magnify a delayed acquisition.

Fast Time-Base Settings. At the fastest time-base settings, only a portion of the waveform shows in the display. The waveform record icon indicates that portion with brackets. Push the zoom  button and then use the horizontal POSITION control to scroll through the entire waveform to see any portion you want. The affected time-base settings are shown below.

Acquisition resolution	Affected time-base settings
Normal	100 ns/div to 1 ns/div
Fast Trigger	4 ns/div to 1 ns/div

At the fastest time-base settings, the maximum zoom magnification factor is also reduced.

Delay Interactions. The maximum delay setting is a function of the time-base setting and acquisition resolution. If you set a large positive or negative delay, that amount of delay might be automatically reduced if you make the following additional control changes:

- Change to a faster time-base setting
- Change from Fast Trigger to Normal acquisition resolution

If the delay reduction occurs, it may cause the waveform horizontal position to shift.

Negative Delay. You can select up to ten divisions of negative delay. At the fastest time base settings, you can use negative delay to see more of the waveform that occurs before the trigger point.

Roll Mode Display. To obtain a rolling display similar to a strip-chart recorder, turn off zoom and delay, select the Auto trigger mode, and set the horizontal SCALE control to 40 ms/div or slower. Subsequent changes to the horizontal SCALE cause the roll-mode display to erase and restart.

Measure

Push the MEASURE button to show the measure menu.

MEASURE



	Bottom	Side	Description
	Select Measurement		See table on page 3-44 for a description of the automatic measurements.
	Remove Measurement	Measurement 1 Measurement 2 Measurement 3 Measurement 4	Removes a specific measurement.
		All Measurements	Removes all measurements.
	Gating	Off	Use to take measurements on the full waveform record.
		Screen	Use to take measurements on the portion of the waveform on screen.
		Cursors	Use to take measurements on the portion of the waveform between the V Bar cursors.
		Bring Selected Cursor to Center Screen	Moves the active cursor to center screen.
		Bring Both Cursors On Screen	Moves any off-screen cursor onto the screen.

Bottom	Side	Description
High-Low Setup	Auto Select	Automatically uses the best measurement method depending on the signal characteristics.
	Histogram	Use to measure pulses.
	Min-Max	Use to measure other wave shapes.
Reference Levels	Set Levels in % or units	Use to choose custom reference levels in relative or absolute units.
	High Reference	Sets custom high reference level.
	Mid Reference	Sets custom mid reference level.
	Mid 2 Ref	Sets the custom mid reference level for the Delay and Phase measurement second waveform.
	Low Reference	Sets custom low reference level.
	Set to Defaults	Sets reference levels to default values.
Indicators	Measurement 1 - Measurement 4	Selects the measurement for which to display markers that show the portion of the waveform used to calculate the measurement value.
	Off	Turns measurement indicators off.

Key Points

Choosing Measurements. You can perform up to four automatic measurements and display them along the right side of the graticule. All four measurements can apply to a single channel or you can spread the measurements over several channels. You can also take measurements on math and reference waveforms.

First push a channel, MATH, or REF button to select the waveform you want to measure and then select a measurement. The table beginning on page 3-44 describes the measurements in detail.

Measurement Interaction with Preview. If you change a vertical or horizontal control setting while acquisition is stopped or is waiting for trigger, measurements track the changes and remain valid.

Taking Gray-Scale Measurements. Using cursors is often the best way to take simple measurements on waveforms that contain significant gray-scale information. The automatic measurements operate only on the latest acquisition, not on the previous acquisitions that are displayed in gray scale. However, you can set the cursors to surround and measure the gray-scale area of the waveform.

High-Low Setup. The oscilloscope determines the 10%, 50%, or 90% levels of the waveform and then uses them to calculate the measurements. You can choose the method used to determine these levels:

- **Histogram** sets the values statistically; it finds the most common value either above or below the midpoint (depending on whether it is defining the high or low reference level). Since this statistical approach ignores short-term aberrations (overshoot, ringing, noise), histogram is the best method for measuring digital waveforms and pulses.
- **Min-max** uses the highest and lowest values of the waveform record. This method is best for measuring waveforms that have no large, flat portions at a common value, such as sine waves and triangle waves.
- **Auto Select** chooses one of the above methods automatically depending on the signal characteristics. Auto Select chooses the histogram method if the histogram contains prominent peaks. If not, Auto Select chooses the min-max method.

Measurement Gating. You can use the gating feature to limit measurements to the portion of the waveform that is on the screen or between the cursors.

When you turn Screen gating on, the oscilloscope only uses the waveform points on screen in its measurements. This function is useful at the fastest time base settings or when you want to take measurements on a magnified waveform (when zoom  is on).

When you turn Cursor gating on, the oscilloscope displays vertical bar cursors. Use the general purpose knob and SELECT button to place the cursors around the area of interest.



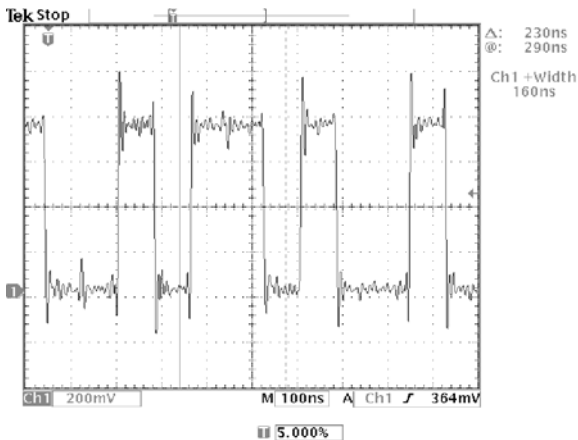





In the example below, the cursors surround the second positive-going pulse so the oscilloscope can measure the width of that pulse.

















When gating is off, the oscilloscope takes measurements over the entire waveform record.

Using Measurement Gating with Cursors. If V Bar cursors are already on when you select Cursor gating, the cursors do both functions at the same time. The cursor readouts are displayed at the same time that the cursors gate the automatic measurements.

If H Bar cursors are on when you select cursor gating, the H Bar cursors are turned off.

Measurement name	Definition
 Amplitude	Measured over the entire waveform. <i>Amplitude = High (100%) - Low (0%)</i>
 Burst Width	The duration of a burst. Measured over the entire waveform.
 Cycle Mean	The arithmetic mean over the first cycle in the waveform.
 Cycle RMS	The true Root Mean Square voltage over the first cycle in the waveform.
 Delay	Timing measurement. The time between the MidRef crossings of two different waveforms or the gated region of the waveforms.
 Fall Time	Time that the falling edge of the first pulse in the waveform takes to fall from 90% to 10% of its amplitude.
 Frequency	Reciprocal of the period of the first cycle in the waveform. Measured in Hertz (Hz).
 High	The value used as 100%. Calculated using either the min/max or the histogram method. Measured over the entire waveform.

Measurement name	Definition
 Low	The value used as 0%. Calculated using either the min/max or the histogram method. Measured over the entire waveform.
 Max	The maximum amplitude. The most positive peak voltage measured over the entire waveform.
 Mean	The arithmetic mean over the entire waveform.
 Min	The minimum amplitude. The most negative peak voltage measured over the entire waveform.
 Negative Duty Cycle	Measurement of the first cycle in the waveform. $\text{Negative Duty Cycle} = \frac{\text{Negative Width}}{\text{Period}} \times 100\%$
 Negative Overshoot	Measured over the entire waveform. $\text{Negative Overshoot} = \frac{\text{Low} - \text{Min}}{\text{Amplitude}} \times 100\%$
 Negative Width	Measurement of the first negative pulse in the waveform. The time between the 50% amplitude points.
 Pk-Pk	Measured over the entire waveform. $\text{Peak-to-peak} = \text{Max} - \text{Min}$
 Period	Time it takes for the first complete signal cycle to complete in the waveform. Measured in seconds.
 Phase	Timing measurement. The amount one waveform leads or lags another in time. Expressed in degrees, where 360° comprise one waveform cycle.

Measurement name	Definition
 Positive Duty Cycle	Measurement of the first cycle in the waveform. $\text{Positive Duty Cycle} = \frac{\text{Positive Width}}{\text{Period}} \times 100\%$
 Positive Overshoot	Measured over the entire waveform. $\text{Positive Overshoot} = \frac{\text{Max-High}}{\text{Amplitude}} \times 100\%$
 Positive Width	Measurement of the first positive pulse in the waveform. The time between the 50% amplitude points.
 Rise Time	Time that the leading edge of the first pulse in the waveform takes to rise from 10% to 90% of its amplitude.
 RMS	The true Root Mean Square voltage over the entire waveform.
Snapshot All Measurements	Displays all measurement values (except two-channel measurements) at the time you pushed the Snapshot All Measurements button, for the selected waveform. Push the Snapshot All Measurements button to update the list values. Push the MENU OFF button to clear the list from the screen.

QuickMenu

QUICKMENU



Push the QUICKMENU button to see a set of frequently used menu functions on the display. QuickMenus simplify oscilloscope operation and can increase your productivity.

Scope is a standard QuickMenu for general purpose oscilloscope use. Some optional application modules also include a custom QuickMenu display. See page 1-29 for an example of the Scope QuickMenu.

Key Points

Using the QuickMenus. To use a QuickMenu, push the screen button that corresponds to the control you need to set. Push the screen button repeatedly to choose one of the settings. The small arrow icon indicates that there are additional settings available that are not shown.

You can use most of the front-panel controls at the same time you are using a QuickMenu. For example, if you push a channel button to select a different channel, the QuickMenu changes to show information about that channel.

Using Other Menus. You can still use the regular menus. For example, if you push the MEASURE button, you can set up and take automatic waveform measurements in the usual way. If you return to the QuickMenu, the measurement is still displayed on the screen.

Selecting Between QuickMenus. You may have optional application modules installed that also have QuickMenu displays. To select the QuickMenu you want to use, push the MENU screen button. This menu item is shown only if application modules that contain a QuickMenu are installed.

Save/Recall

Push the SAVE/RECALL button to show the save/recall menu.

SAVE/RE-
CALL



	Bottom	Side	Description
Save Current Setup		To File	Saves a setup to disk.
		To Setup 1 ... To Setup 10	Saves a setup to nonvolatile memory.
Recall Saved Setup		From File	Recalls a setup from disk.
		Recall Setup 1 ... Recall Setup 10	Recalls a setup from nonvolatile memory.
Recall Factory Setup		OK Confirm Factory Init	Initializes the setup.
Save Wfm		To File	Saves one or more waveforms to a file. Selecting this menu item changes the side menu contents. See page 3-50.
		To Ref1 ... To Ref4	Saves the selected waveform to nonvolatile memory. See page 3-51.
Recall Wfm		From File Recall Ref1 ... Recall Ref4	Recalls a waveform from disk and displays it as a reference waveform.

Bottom	Side	Description
File Utilities		Accesses floppy disk file utilities. Refer to description on page 3-52.
Labels		Lets you assign unique labels to reference waveforms and instrument setups stored in nonvolatile memory. Refer to page 3-54 for a description of how to edit label text.

Key Points

Saving Setups. To save the current setup to nonvolatile memory, push the Save Current Setup screen button and then select one of the ten storage locations. Then, push the OK Overwrite Saved Setup screen button to complete the operation or the MENU OFF button to cancel the operation.

Recalling Setups. To recall a setup from nonvolatile memory, push the Recall Setup screen button and then select one of the ten storage locations.

Recalling the Factory Setup. Recall the factory setup to initialize the oscilloscope to a known setup. *Appendix B* describes the Factory Setup in detail.

To recall the factory setup, push the Recall Factory Setup screen button. Then, push the OK Recall Factory Setup screen button to complete the operation.

Saving a Waveform to File. When you push the **To File** side menu button, the oscilloscope changes the side menu contents. The following table describes these side menu items for saving data to a disk file.

Side menu button	Description
Internal File Format	Sets the oscilloscope to save waveform data to disk in internal waveform save file (.isf) format. This format is the fastest to write and creates the smallest-sized files. Use the internal waveform format if you intend to recall a waveform and store it into reference memory for viewing or measuring.
Spreadsheet File Format	Sets the oscilloscope to save waveform data to disk as a comma-separated data file compatible with most spreadsheet programs.
Mathcad File Format	Sets the oscilloscope to save waveform data to disk in Mathcad format. Use this format if you intend to import the waveform data into Mathcad software.
Save Active Waveforms to Consecutive Files	Immediately saves all active waveforms to consecutively-numbered files in internal save file (.isf) format. This menu item is only available when the Internal File Format is selected.
Save Active Waveforms to Selected File	Immediately saves all active waveforms to a single spreadsheet or Mathcad format file. This menu item is only available when either spreadsheet or Mathcad file format is selected.
Save <wfm> to selected file	Immediately saves the selected active waveform, math waveform, or reference waveform data to disk using the selected file format.

Saving a Waveform to Reference Memory. To save a waveform to nonvolatile memory, first select the waveform you want to save. Push the Save Wfm screen button and then select one of the four reference waveform locations. See page 3-86 for an alternate method you can use to save waveforms.

Saved waveforms contain only the most current acquisition; gray-scale information, if any, is not saved.

Displaying a Reference Waveform. To display a waveform stored in nonvolatile memory, push the REF button and then push the Ref1, Ref2, Ref3, or Ref4 screen button.

When a reference waveform is selected, it appears brighter than other reference waveforms. Reference waveforms do not contain gray-scale information.

Removing a Reference Waveform from the Display. To remove a reference waveform from the display, push the REF button and then the Ref1, Ref2, Ref3, or Ref4 screen button to select a reference waveform. Push the waveform off  button. The reference waveform is still in nonvolatile memory and can be displayed again.

Erasing All Setups and Waveforms. See *Tek Secure* on page 3-73 for instructions on how to erase all setups and waveforms saved in nonvolatile memory.

Using the Floppy Disk Drive

This section describes how to use the disk drive. The File Utilities submenu is shown below.

SAVE/RE-CALL

Bottom	Side	Description
File Utilities	Delete	Deletes a file.
	Rename	Renames a file.
	Copy	Copies a file to another directory.
	Print	Prints a file to a printer connected to one of the hard copy ports.
	Create Directory	Creates a new directory.
	Confirm Delete	Turns On or Off a confirmation message before files are deleted.
	Overwrite Lock	Sets file overwrite protection to On or Off.
	Format	Formats a disk (erases all files).

Key Points

Upgrading Firmware. You can use the disk drive to upgrade the oscilloscope firmware or install new application packages. See the documentation provided with these packages for instructions.

Navigating the File System. When you insert an IBM-formatted disk and push the File Utilities screen button, the oscilloscope shows a list of directories and files on the disk.

Use the general purpose knob to select a directory or file. To change the working directory, select the directory and then push the SELECT button. To move up one directory level, select .. and then push the SELECT button.

Automatic File Numbering. The oscilloscope gives all files created by the oscilloscope the default name TEK?????, where the question marks are placeholders for an automatic number sequence from 00000 to 99999.

You can change the TEK????? file to a new name with up to eight characters. If you use fewer than eight characters and include trailing question marks, the oscilloscope numbers the files sequentially if more than one are saved with the same base name.

For example, if you rename the TEK?????.ISF file to TEST??.ISF for a series of saved waveforms, the oscilloscope saves the first one as TEST00.ISF, the second one as TEST01.ISF, up to the last one as TEST99.ISF.

Editing File, Directory, Reference Waveform, or Instrument Setup Names.

You can edit file names, directory names, reference waveform and instrument setup labels, and Ethernet parameters (TDS3EM only). Use the general purpose knob to select an alphanumeric character. Use the screen buttons described below to edit and enter the new name.

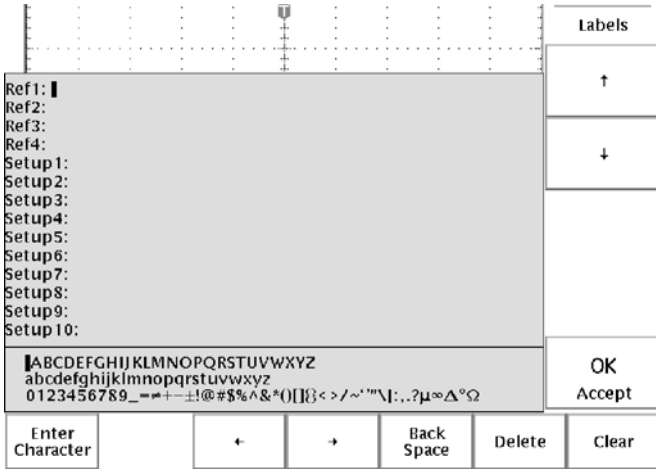

Screen button	Function
Enter Char	Enters the selected character into the field.
← and →	Moves the cursor to a different character in the field.
Back Space	Deletes the character before the cursor location.
Delete	Deletes the character at the cursor location.
Clear	Erases the current field value.
↑ and ↓	Selects the field that you want to edit.
OK Accept	Applies all field values.
MENU OFF	Exits the menu without applying field values.

Deleting Files. To delete a file, select the file with the general purpose knob, push the Delete screen button, and then push the OK Delete screen button when you see the confirmation screen.

If you do not want to see a confirmation screen each time you delete a file, push the Confirm Delete screen button to set it to Off.

Renaming Files. To rename a file, select the file with the general purpose knob, push the Rename screen button, and then follow the instructions on page 3-54.

Once a directory is created, you cannot rename it. However, you can delete the directory and create a new one with a new name.

Copying Files and Directories. To copy a file or directory, select the file or directory with the general purpose knob and push the Copy screen button. Now use the general purpose knob and SELECT button to select a destination directory. Push the copy confirmation screen button to complete the operation.

Printing Files. You can print files through any installed printer port to your printer. This function is especially useful if you want to print hard copy files that you have stored on a disk.

To print a file, select the file with the general purpose knob. Push the Print screen button and then select the port to which your printer is connected. Make sure that the oscilloscope is set to send the correct file format to your printer.

Creating a Directory. To create a directory, use the general purpose knob and SELECT button to select the working directory where you want the new directory to reside. Push the Create Directory screen button and then follow the instructions on page 3-54.

Formatting a Disk. The oscilloscope can format 1.44 MB IBM-compatible disks. To format a disk, insert it into the disk drive. Push the Format screen button and then push the OK Confirm Format screen button to confirm the operation. If you decide not to format the disk, push the MENU OFF button to stop the format operation.



CAUTION. *To avoid loss of data, do not format disks that already contain important data. When you format a disk, all files and directories will be erased and can never be recovered.*

Setting Protections. The oscilloscope provides two protections to help you prevent accidental loss of data:

- Confirm Delete shows a confirmation message each time you try to delete a file. You can turn Confirm Delete off if you do not want to see the message.
- Overwrite Lock prevents the oscilloscope from writing over existing files. You can turn Overwrite Lock off if you want to be able to write over existing files.

File Extensions. Files written by the oscilloscope have the following extensions. The oscilloscope can only read files with the SET, MSK, and ISF extensions.

File extension	File type
*.SET	Saved setup file
*.ISF	Saved waveform file, Internal format
*.CSV	Saved waveform file, Spreadsheet format
*.DAT	Saved waveform file, Mathcad format
*.TJ	Hard copy file, Thinkjet format
*.DJ	Hard copy file, Deskjet format
*.LJ	Hard copy file, Laserjet format
*.IBM	Hard copy file, Epson format
*.IMG	Hard copy file, Interleaf format
*.TIF	Hard copy file, TIFF format
*.RLE	Hard copy file, RLE format
*.PCX	Hard copy file, PCX format
*.BMP	Hard copy file, BMP format
*.EPS	Hard copy file, EPS format
*.BJC	Hard copy file, Bubble Jet format
*.DPU	Hard copy file, Seiko DPU-3445 format
*.GZ	Gnuzip-compressed hard copy file
*.MSK	Mask geometry file (requires TDS3TMT module)
*.PNG	Hard copy file, Portable Network Graphics format
*.PRT	Hard copy file, TDS3PRT thermal printer format
*.C60, *.C80	Hard Copy file, Epson C60 or C80 inkjet format

Trigger Controls

MENU

Push the trigger MENU button to show the trigger menu and then push the Type screen button to select Edge or Video. See pages 3-64 and 3-69 for descriptions of Edge and Video trigger.

See the TDS3TRG Advanced Trigger user manual, or (if installed) the TDS3VID Extended Video application module user manual, for more information.



Trigger Level

Use the trigger LEVEL control to adjust the trigger level. When you change the trigger level, a horizontal line temporarily appears to show you the level on screen. After the line disappears, the trigger level is marked with a small arrow.

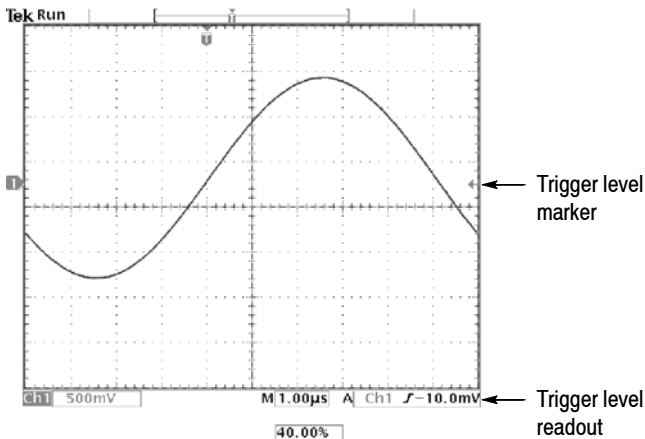

SET TO 50%

Set to 50%

Push the SET TO 50% button to set the trigger level to the 50% amplitude level of the trigger source waveform.

**FORCE
TRIG****Force Trigger**

Push the FORCE TRIG button to force an immediate trigger event, even in the absence of a signal. This function is useful in these situations:

- If you do not see a waveform on the screen when using Normal trigger mode, push FORCE TRIG to acquire the signal baseline to verify that it is on the screen.
- After you push the SINGLE SEQ button to set up for a single shot acquisition, you can push the FORCE TRIG button to do a practice acquisition to verify the control settings.

B TRIG**B Trigger**

To use the B trigger, the A trigger type must be Edge. Push the trigger MENU and B TRIG buttons to show the B-trigger menu and to activate triggering using both the A and B triggers. The light next to the B TRIG button indicates B trigger is active. Push the B TRIG button again to return to the single A trigger.

Bottom	Side	Description
B Trigger After A	B Trigger After A Time	Sets the oscilloscope to trigger on the next B-trigger event that occurs after a specified period of time from the A trigger. Use the general purpose knob to set the time value.
	Set to Delay Time (B→▼) then Set (B→▼) to 0s	Sets the B Trigger After A Time value to the horizontal B→▼ value, then sets B→▼ to zero seconds. B→▼ is the delay time from the B trigger point to the expansion point (center screen).
	Set to Min	Sets B Trigger After A time to 26.4 ns.
	B Events	Sets the oscilloscope to trigger on the <i>n</i> th B-trigger event after the A trigger. Use the general purpose knob to set the event value.
	Set to Min	Sets the B events count to 1.
Source		Sets Source, coupling, slope, and level for the B trigger. These settings are independent of similar settings for the A trigger. See page 3-64 for descriptions of these menu items.
Coupling		
Slope		
Level		

The trigger wait time is the minimum time between the A and B triggers. The trigger wait time is not the same as the horizontal delay time. You can use the horizontal delay function to delay acquisition relative to any trigger event, whether it is from the A trigger alone or from a trigger setup that involves both the A and B triggers.

The following figures show wait-for-time and wait-for-events triggering and how they relate to the horizontal delay time.

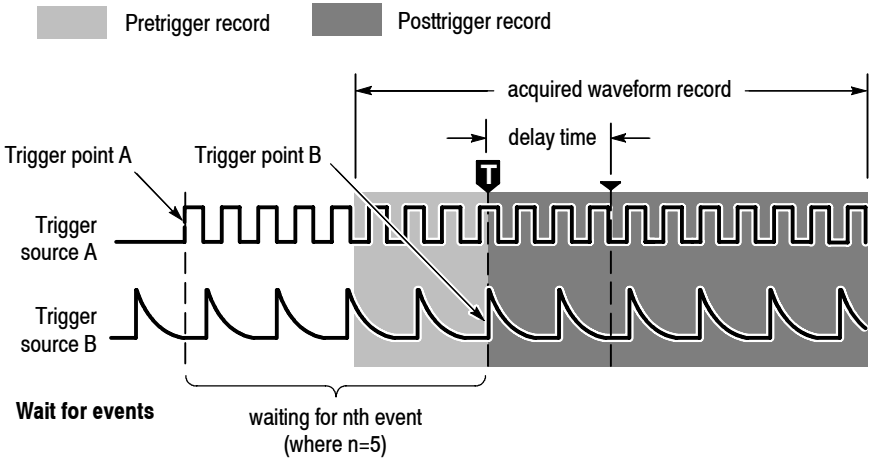
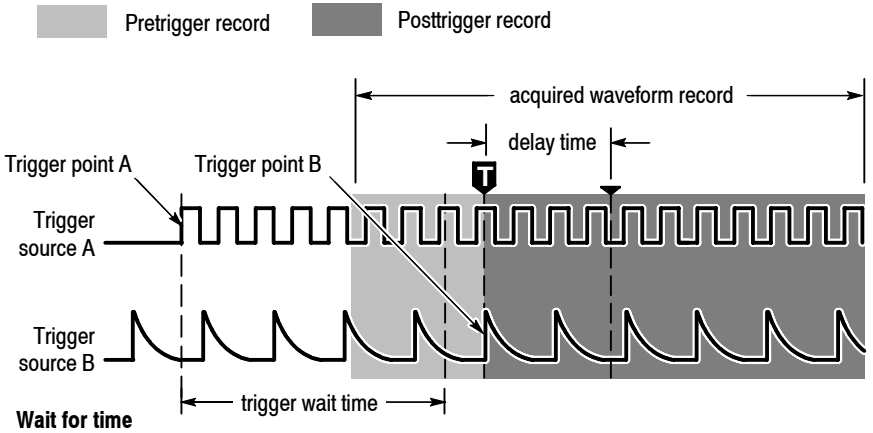

After the A trigger event is recognized, the oscilloscope begins counting B trigger events. However, for the first B event to be counted, that event must consist of both an opposite-polarity edge and the edge that is counted. The opposite-polarity edge must occur ≥ 5 ns after the A trigger arming event. If this condition is not met, the oscilloscope does not count the first event, which results in a trigger on the $n+1^{\text{st}}$ event. Refer to the following figure, where $n=3$ and A and B trigger slopes are set to rising edge.

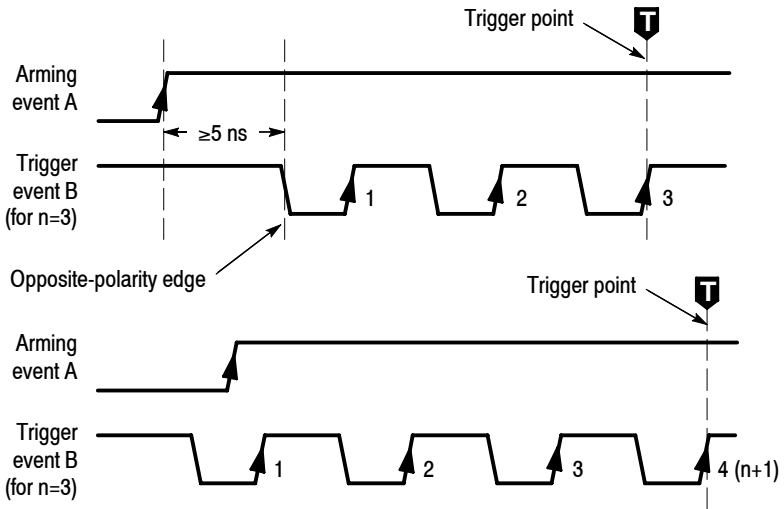

Trigger Status

The readout at the top of the screen shows you the current trigger status. The table below explains the trigger status indicators.

Trigger status	Explanation
Auto	The oscilloscope is acquiring using auto trigger. Valid trigger events, if any, are infrequent.
Trig'd	The oscilloscope is acquiring using valid trigger events that are frequent enough to avoid auto triggering.
PrTrig	The oscilloscope is acquiring the pretrigger part of the waveforms. This status is shown only at the slowest time/division settings.
Trig?	The oscilloscope has acquired the pretrigger part of the waveforms and is waiting for a valid trigger event.
BTrig?	The A trigger event has occurred. The oscilloscope is armed and waiting for a valid B trigger event.

Edge Trigger

Use Edge triggering to trigger on the rising or falling edge of the input signal at the trigger threshold.

MENU

Bottom	Side	Description
Type = Edge		
Source	Ch1 - Ch4	Sets the trigger source to a specific channel.
	AC Line	Sets the trigger source to use the AC line signal (not available when operating with batteries).
	Ext	Sets the oscilloscope to trigger on the external trigger source. Ext/10 attenuates the external trigger signal by a factor of 10. See page 3-67.
	Ext/10	
	Ext Probe nnX Voltage / Current (4-channel only)	Set this value to match the attenuation factor and the type of probe (voltage or current) that is attached to the external trigger connector. Push the menu button to select the probe type. Use the general purpose knob to set the attenuation factor. The default values are 1x and voltage.
Vert	Sets the trigger source to the lowest-numbered active channel in the display.	

Bottom	Side	Description
Source (cont.)	Alternating (all active channels)	Sequentially uses each active channel as a trigger source, from the lowest-numbered active channel to the highest-numbered active channel. See page 3-67.
Coupling	DC	Selects DC coupling.
	HF Reject	Rejects frequencies above 30 kHz in the trigger signal.
	LF Reject	Rejects frequencies below 1 kHz in the trigger signal.
	Noise Reject	DC coupling with low sensitivity to reject noise in the trigger signal.
Slope	/ (rising edge)	Triggers on the rising edge of a signal.
	\ (falling edge)	Triggers on the falling edge of a signal.
Level	Level	Use to set the trigger level with the general purpose knob.
	Set to TTL	Sets the trigger level to +1.4 V for TTL logic.
	Set to ECL	Sets the trigger level to -1.3 V for ECL logic ($V_{ee} = -5.2$ V).
	Set to 50%	Sets the trigger level to the 50% amplitude level of the signal.

Bottom	Side	Description
Mode & Hold-off	Auto (untriggered roll)	Enables free-running and roll-mode acquisitions.
	Normal	Triggers only on valid trigger events.
	Holdoff (time)	Sets holdoff to a specific time.
	Holdoff (% of record)	Sets holdoff to a percent of the record duration.
	Set to Min	Sets holdoff to the minimum value.

Key Points

Displaying the Trigger Source. You do not have to display a channel to use it as a trigger source.

Normal and Auto Mode. Use Normal trigger mode when you want to trigger only on a valid event. Use Auto trigger mode when you want the acquisition to occur, even when there is not a valid trigger event. Also choose Auto when you want a rolling waveform, with no trigger, at the slower time base settings. See page 3-38 for more information about roll mode.

External Trigger. The trigger level range for the EXT setting is -0.8 V to +0.8 V. The trigger level range for the EXT/10 setting is -8 V to +8 V.

For best external trigger performance, apply a square-wave signal with amplitude greater than the specified minimum level range and with well-defined transitions.

Alternating Trigger. Alternating trigger sequentially uses each active channel as a trigger source, from the lowest-numbered active channel to the highest-numbered active channel. Alternating trigger is available in all trigger menus except for logic triggers.

Alternating trigger uses the current trigger settings to trigger on all active channels; there is not a separate trigger setup for each channel. Therefore, the trigger settings must be able to trigger on all active signals in order to produce a stable triggered display. If one or more of the source signals do not meet the trigger settings, the oscilloscope either waits for that source channel to trigger (Normal trigger mode) or autotrigger (Auto trigger mode).

Due to image persistence, all alternating trigger active channels may appear to be synchronized. However, this does not mean that the displayed signals are synchronized. Also, alternating trigger does not use EXT, EXT/10, or Line signals as trigger sources.

Holdoff. You can use holdoff to help stabilize the display of complex waveforms. After you press the Mode & Holdoff screen button, use the general purpose knob to set the holdoff time as an absolute value or as a percent of the record duration.

Holdoff begins when the oscilloscope recognizes a trigger event and disables the trigger system until acquisition is complete. The trigger system remains disabled during the holdoff time.

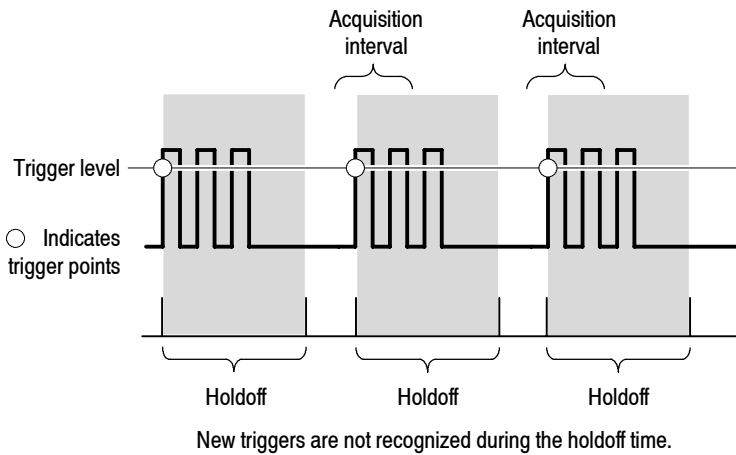

NOTE. For best results, choose Normal trigger mode when using long holdoff settings (10 ms or greater).

Video Trigger

Choose video triggering to trigger on the odd fields, even fields, or on all the lines of an NTSC, PAL, or SECAM video signal. See the TDS3VID Extended Video or TDS3SDI 601 Digital Video application module manual for more information if that module is installed.

MENU

Bottom	Side	Description
Type Video		
Standard	525/NTSC	Triggers on a NTSC signal.
	625/PAL	Triggers on a PAL signal.
	SECAM	Triggers on a SECAM signal.
Source		See page 3-64 for descriptions of these menu items.
Trigger On	Odd	Triggers on odd or even fields in an interlaced signal.
	Even	
	All Fields	Triggers on any field in an interlaced or noninterlaced signal.
	All Lines	Triggers on all lines.
Mode & Holdoff		See page 3-66 for descriptions of these menu items.

Key Points

Displaying the Trigger Source. You do not have to display a channel to use it as a trigger source.

Sync Pulses. When you choose Video, the trigger always occurs on negative-going sync pulses. If your video signal has positive-going sync pulses, invert the signal using the Vertical menu. See page 3-81 for information about inverting a signal.

Utility

The following are examples of what you can do with each of the six branches in the Utility menu:

- Use Config to select a language or set the time and date.
- Use Apps if an installed application module places items in this menu. See the documentation provided with your application packages for more information.
- Use I/O to set up the communication ports.
- Use Hard Copy to set up hard copy parameters. Refer to *Hard Copy* on page 3-27 for information about setting up and printing a hard copy.
- Use Cal to compensate the signal path.
- Use Diags to run internal diagnostic routines.

Push the UTILITY button to show the utility menu. Then, push the System screen button to choose the branch. The remaining items in the utility menu change depending on the branch you choose.

Configure System

Use the System Config branch to access these functions.

UTILITY



Bottom	Side	Description
System Config		
Language	English	Use to choose your native language. Most on-screen text appears in the language you choose.
	Français	
	Deutsch	
	Italiano	
	Español	
	Português	
	(Russian)	
	(Japanese)	
	(Korean)	
	(Simplified Chinese)	
	(Traditional Chinese)	
Set Date & Time	Display Date/Time	Use to turn the date/time display On or Off.
	Hour Min	Use to set the internal clock with the current hour and minute.
	Month Day	Use to set the internal clock with the current month and day.
	Year	Use to set the internal clock with the current year.
	OK Enter Date/Time	Sets the date and time of the internal clock.

Bottom	Side	Description
Battery Time-Outs	Power Off Time-Out	Use to set the time before an automatic shut down.
	Backlight Time-Out	Use to set the time before the backlight automatically turns off.
Tek Secure Erase Memory		Erases all nonvolatile waveform and setup memory.
Version		Use to see the firmware version.

Key Points

Setting the Date and Time. To set the internal clock with the current date and time, push the Set Date & Time screen button. Use the general purpose knob to set the values after you push the screen buttons for the year, day and month, hour and minute. Push the OK Enter Date/Time screen button to complete the operation.

Power Off Time-Out. Use this feature to automatically turn the oscilloscope to standby if it is not being used. Use the general purpose knob to set the power off time-out delay to a fixed time or to ∞ (time-out off). Cycle the power switch to turn the oscilloscope back on after an automatic shut down.

Power off time-out operates only when you use battery power.

Backlight Time-Out. Press this button to adjust the backlight time-out delay. This feature automatically turns the backlight off after a period of time if the oscilloscope is not being used. Use the general purpose knob to set the backlight time-out delay to a fixed time or to ∞ (time-out off). Push any button to turn the backlight back on after an automatic time-out.

Backlight time-out operates only when you use battery power.

Tek Secure. If you have acquired confidential data on your oscilloscope, you may want to execute the Tek Secure function before you return the oscilloscope to general use. The Tek Secure function does the following tasks:

- Replaces all waveforms in all reference memories with null sample values
- Replaces the current front-panel setup and all stored setups with the factory setup
- Calculates the checksums of all waveform memory and setup memory locations to verify successful completion of waveform and setup erasure
- Displays a confirmation or warning message if the checksum calculation is successful or unsuccessful

After you execute the Tek Secure function, you must turn off the oscilloscope power and then turn the power back on to complete the process.

I/O System

Use the System I/O branch to access these functions.



Bottom	Side	Description
System I/O		
GPIB (TDS3GV)	Talk/Listen Address	Sets the GPIB address.
	Hard Copy (Talk Only)	Sets the GPIB port to talk only for making hard copies.
	Off Bus	Disables the GPIB port.
	Debug	Enables and disables a message window to help you debug GPIB problems.
RS-232 (TDS3GV)	Baud Rate	Sets the baud rate in steps from 1200 to 38400.
	Flagging	Use to enable hard flagging (RTS/CTS) or turn flagging off.
	EOL	Selects end-of-line terminator.
	Debug	Enables and disables a message window to help you debug RS-232 problems.
	Set RS-232 Parameters to Default Values	Sets baud rate = 9600, hard flagging = on, and EOL = LF.

Bottom	Side	Description
Ethernet Network Settings	Change Instrument Settings	Displays a list of fields in which you set oscilloscope Ethernet parameters such as address, instrument name, domain name, and so on. See Appendix G, <i>Ethernet Setup</i> , for information on setting the oscilloscope Ethernet network parameters.
	DHCP/BOOTP	
	Debug	Enables and disables a message window to help you debug Ethernet problems.
	Test Connection	Tests the oscilloscope's Ethernet connection.
Ethernet Printer Settings	Add Printer	Adds, renames, or deletes an Ethernet network printer from the oscilloscope printer list. See Appendix G, <i>Ethernet Setup</i> , for information on setting the oscilloscope Ethernet network printer parameters.
	Rename Printer	
	Delete Printer	
	Confirm Delete	Enables or disables displaying a confirmation message before deleting a printer from the oscilloscope printer list.

Key Points

More Information. Refer to the *TDS3000 & TDS3000B Series Digital Phosphor Oscilloscope Programmer Manual* for more information about using the Ethernet, RS-232 and GPIB ports.

RS-232 Troubleshooting. If you are having difficulties with RS-232 communication, try the following remedies:

- Verify that you are using the correct RS-232 cable and adapters. Most computers require a null-modem connection to the oscilloscope. Most printers require a straight-through connection to the oscilloscope.
- Verify that the RS-232 cable is connected to the correct port on your computer or hard copy device.
- Reset the RS-232 parameters to defaults and then set the baud rate to match the computer or hard copy device. The default settings (except baud rate) are standard on most computers and hard copy devices.
- Enable the debug window to see the RS-232 status, errors, data transmitted, and data received.

GPIB Guidelines. Follow these guidelines when you connect your oscilloscope to a GPIB network:

- Turn off the oscilloscope and all external devices before connecting the oscilloscope to the GPIB network.
- Assign a unique device address to the oscilloscope. Two devices cannot share the same device address.
- Turn on at least two-thirds of the GPIB devices while using the network.

Calibration System

Use the System Cal branch to access these functions.



Bottom	Side	Description
System Cal		
Signal Path		Compensates the signal paths to obtain best measurement accuracy.
Factory Cal		Used to calibrate the oscilloscope. This is a service function only.
Cal Due Control	Notify After Hours of Operation	Sets the number of hours of operation before notifying you that a calibration is due.
	Notify After Years of Elapsed Time	Sets the number of years before notifying you that a calibration is due.

Key Points

Signal Path Compensation. For maximum accuracy at any time, run the signal path compensation routine just before taking critical measurements. To meet accuracy specifications, run the routine if the ambient temperature changes by 10° C or more.

Before running the routine, disconnect any probes or cables from the channel inputs. Then, push the Signal Path and OK Compensate Signal Path screen buttons to confirm that you are ready to proceed. The routine takes several minutes to complete.

Factory Cal. Service personnel use these functions to calibrate the oscilloscope internal voltage references using external sources. Refer to your Tektronix field office or representative for assistance with these processes.

Cal Due Control. The calibration due notification occurs only in the power-on screen. Set the controls to ∞ if you do not want to be notified when calibration is due.

Diagnostic System

Use the System Diag branch to access these functions.



Bottom	Side	Description
System Diags		
Execute		Starts diagnostics.
Loop	Once	Executes the diagnostic loop once.
	Always	Executes the diagnostic loop continuously.
	Until Fail	Executes until a failure occurs.
Error Log	Page Up	Use to see the previous error log page.
	Page Down	Use to see the next error log page.

Key Points

Starting Diagnostics. To execute the built-in diagnostic routines, disconnect all cables or probes from the oscilloscope inputs, and then push the OK Run Test screen button.

Stopping Diagnostics. Choose how you want the diagnostic routines to execute:

- **Loop Once** runs all diagnostic routines one time and then stops.
- **Loop Always** runs the diagnostic routines continuously. Push the **RUN/STOP** and then the **MENU OFF** buttons to resume normal operation.
- **Loop Until Fail** runs the diagnostic routines until the oscilloscope fails a test or until you cycle the power.

Error Log. The error log contains summary data gathered over the life of the oscilloscope. The error log lists the last 100 errors encountered. The last error in the list is the most recent.

Under normal circumstances, the error log should be empty. Any entry in the error log may indicate a hardware failure or firmware fault. If you can repeatedly cause an entry to be added to the error log, please contact a Tektronix service representative for assistance.

Vertical Controls

You can use the vertical controls to select waveforms, adjust the waveform vertical position and scale, and set input parameters. All vertical operations affect the selected waveform. Push a channel button (CH 1, CH 2, CH 3, or CH 4), the MATH button, or the REF button to select a waveform.



Vertical Position Control

Use the vertical POSITION control to locate the selected waveform in the display. When you change the vertical position, a horizontal line temporarily appears to show you the ground reference level on the screen. After the line disappears, the ground reference level is marked at the left of the graticule.

If acquisition is stopped you can still reposition waveforms for analysis. The new position setting is used when acquisition resumes.



Waveform Off

Push the waveform OFF button to remove the selected waveform from the display. You can still use the channel as a trigger source.



Vertical Scale Control

Use the vertical SCALE control to set the vertical scale factor of the selected waveform in 1-2-5 increments. If acquisition is stopped you can still rescale waveforms for analysis. The new scale setting is used when acquisition resumes.

You can also make fine adjustments to the vertical scale. See *Channel Buttons* on page 3-81 for more information.

MENU

Vertical Menu

Push the vertical MENU button to show the vertical menu of the selected waveform. See these pages for more information about the specific vertical menus:

- *Channel Buttons* below
- *Math Button* on page 3-84
- *Ref Button* on page 3-86

CH 1

Channel Buttons

Push a channel button (CH 1, CH 2, CH 3, or CH 4) to select a channel. Each channel button also displays the channel if it is not already displayed. Push the vertical MENU button to show the vertical menu of the selected channel. All vertical operations below affect only the selected waveform.

Bottom	Side	Description
Coupling	DC	Sets input coupling to DC.
	AC	Sets input coupling to AC.
	GND	Provides a 0 V signal reference. The preamplifier disconnects from the input BNC. Input termination remains connected to the input BNC.
	Ω	Sets input resistance to 50 Ω or 1 M Ω , for DC or AC coupling.
Invert	Invert Off	Use for normal operation.
	Invert On	Inverts the polarity of the signal in the preamplifier.

Bottom	Side	Description
Bandwidth	Full Bandwidth	Sets bandwidth to the full oscilloscope bandwidth.
	150 MHz	Sets the bandwidth to 150 MHz (not available on some models).
	20 MHz	Sets the bandwidth to 20 MHz.
Fine Scale	Fine Scale	Enables fine scale adjustment with the general purpose knob.
Position	Vertical Position	Enables numerical vertical position adjustment.
	Set to 0 divs	Sets vertical position to center screen.
Offset	Vertical Offset	Enables vertical offset adjustment with the general purpose knob.
	Set to 0 V	Sets vertical offset to 0 V.
Probe Setup	Voltage Probe	Use to set probe gain or attenuation for probes that do not have the TekProbe II interface.
	Current Probe	
	Deskew	Use to adjust the time skew correction for each probe.
	Set to 0	Use to set probe skew correction to zero.

Key Points

Using Probes with the TekProbe II Interface. When you attach a probe with the TekProbe II interface, the oscilloscope sets the channel sensitivity, coupling, and termination resistance automatically to match the probe requirements.

Vertical Preview. When you change the vertical POSITION or SCALE controls while the acquisition is stopped or it is waiting for the next trigger, the oscilloscope rescales and repositions the selected waveform in response to the new vertical control settings. You may see a clipped waveform if the original acquisition went off the screen. The oscilloscope then uses the new settings for the next acquisition.

In contrast to horizontal preview, the math waveform, cursors, and automatic measurements remain active and valid when using vertical preview.

The Difference Between Vertical Position and Offset. Vertical position is a display function. Adjust the vertical position to place the waveforms where you want to see them. The waveform baseline locations track adjustments made to their positions.

When you adjust vertical offset you see a similar effect, but it is actually quite different. Vertical offset is applied before the oscilloscope preamplifier and can be used to increase the effective dynamic range of the inputs. For example, you can use vertical offset to look at small variations in a large DC voltage. Set the vertical offset to match the nominal DC voltage and the signal appears in the center of the screen.

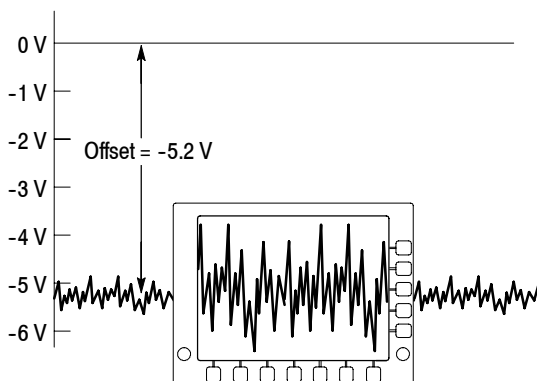

50 Ω Protection. If you select the 50 Ω termination resistance, the maximum vertical scale factor is limited to 1 V/div. If you apply excessive input voltage, the oscilloscope automatically switches to 1 MΩ termination resistance to protect the internal 50 Ω termination.

MATH

Math Button

Push the MATH button to define the math waveform using the math menu. Also push the MATH button to display or select the math waveform. The bottom menu may show other menu items depending on which application module you have installed.

Bottom	Side	Description
Dual Wfm Math	Set 1st Source to	Selects the first source waveform.
	Set Operator to	Selects the math operator: +, -, ×, or ÷
	Set 2nd Source to	Selects the second source waveform.

Key Points

Dual-Waveform Math. For the dual-waveform math operations, the two source waveforms interact with the math operators in the sequence shown below.

Operation	Expression of math waveform
+	Source 1 + Source 2
-	Source 1 - Source 2
×	Source 1 × Source 2
÷	Source 1 ÷ Source 2

Scaling and Positioning the Math Waveform To position or scale a math waveform, select the math waveform and then adjust it with a vertical POSITION or SCALE control. You can do this whether acquisition is running or is stopped.

Math Interaction with Preview. If you select a channel waveform and then adjust the vertical POSITION or SCALE control while the acquisition is stopped, the math waveform remains fixed. It does not track the changes you see to the channel waveform. The same is true if you adjust the horizontal POSITION or SCALE control under these conditions.

Gray-Scale Restriction. Math waveforms are always based on the most current acquisitions and do not contain any gray-scale information.

Source Waveform Screen Position. When displaying dual-waveform math waveforms, make sure that the source waveforms do not extend beyond the top or bottom edge of the screen. If part of the source waveform is positioned outside the screen, the math waveform may not display correctly.



Ref Button

Push the REF button to show the reference menu. Push one of the submenus to display a reference waveform or make it the selected reference waveform.

Bottom	Side	Description
Ref 1	Save Ch1 to Ref1	Saves channel 1 to Ref 1.
	Save Ch2 to Ref1	Saves channel 2 to Ref 1.
	Save Ch3 to Ref1	Saves channel 3 to Ref 1.
	Save Ch4 to Ref1	Saves channel 4 to Ref 1.
	Save Math to Ref1	Saves the math waveform to Ref 1.
Ref 2 Ref 3 Ref 4	Identical settings for the reference waveforms Ref 2, Ref 3, and Ref 4.	

Key Points

Selecting and Displaying Reference Waveforms. You can display all four reference waveforms at the same time. Push the submenu button to select a particular reference waveform. The selected waveform appears brighter than other displayed reference waveforms.

Removing Reference Waveforms from the Display. To remove a reference waveform from the display, select that reference waveform and then push the waveform OFF button .

Scaling and Positioning a Reference Waveform You can position and scale a reference waveform independently from all other displayed waveforms. Select the reference waveform and then adjust it with a vertical or horizontal POSITION or SCALE control. You can do this whether acquisition is running or is stopped.

If a reference waveform is selected, scaling and repositioning of the reference waveform operates the same way whether zoom is turned on or off.

Gray-Scale Restriction. Reference waveforms are always saved from the most current acquisition and do not contain any gray-scale information.

NOTE. The TDS3AAM Advanced Analysis application module adds new math features, including arbitrary math expressions, DPO (grayscale) math waveforms, and FFT analysis.

e*Scope™ Web-based Remote Control

e*Scope introduces the next generation of oscilloscope functionality. With e*Scope you can access any Internet-connected TDS3000B Series oscilloscope from a browser on your work station, PC, or laptop computer. No matter where you are, your TDS3000B is as close as the nearest browser!

There are two levels to e*Scope: basic and advanced. The basic level, which is hosted on the oscilloscope, lets you view a screen image of the current acquisition, save or load waveform and setup files, and send textual control and query commands to the oscilloscope.

The advanced level, which is hosted on your system, provides a graphical user interface to view automatically updated screen images and remotely control the oscilloscope. To obtain the advanced level software, go to the Tektronix TDS3000B website and download the free e*Scope Web-based Remote Control software.

Configuring Your Oscilloscope Ethernet Settings

Before using the e*Scope feature, you must set your oscilloscope Ethernet network settings. Appendix G, *Ethernet Setup*, describes how to enter the Ethernet network parameters for your oscilloscope.

Accessing e*Scope

After your instrument is set up with the correct ethernet settings, you are ready to access that instrument over the internet. To access the oscilloscope e*Scope server, do the following steps:

1. On a PC or work station, open your preferred browser program.
2. In the Location or Address field (where you normally enter a URL), type in the IP address of the TDS3000B instrument to which you want to connect. For example, 188.121.212.107. Do not precede the IP address with any characters. Then press the Return key.
3. The browser program loads the instrument's e*Scope home page, which is an image of the screen contents when your browser accessed the instrument. The e*Scope home page will look something like the following image:

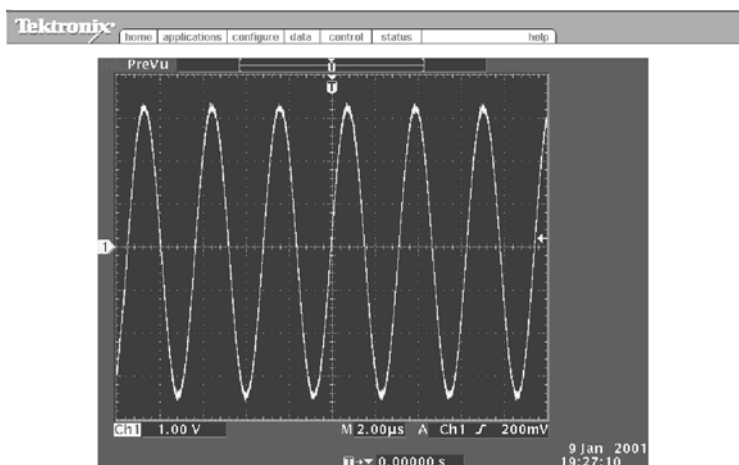

4. If you do not see the e*Scope home page after just a few moments, try the following:
 - a. Verify that the oscilloscope is physically connected to the network.
 - b. Verify that the oscilloscope network settings are correct.
 - c. Push the **Test Connection** side menu button in the Ethernet Network Settings menu to verify that the instrument is electronically connected to the network.

Basic e*Scope Menu Functions

The menu at the top of the page provides the following functions:

Home. Home displays the oscilloscope screen.

Applications. Applications takes you to the application URL specified in the Configure tab.

Configure. Configure lets you specify URLs for the advanced Web-based Control HTML pages (accessed from the Control menu)

Data. Data provides the basic level of e*Scope control. It lets you upload or download waveform data files and oscilloscope settings, as well as remotely control the oscilloscope using oscilloscope programming commands listed in the *TDS3000 & TDS3000B Digital Phosphor Oscilloscope Programmer Manual*.

Status. Status displays the version screen, which shows the firmware version and lists installed application modules.

Control. Control displays the advanced e*Scope Web-based Remote Control screen that lets you remotely control the oscilloscope using a graphical user interface that includes on-screen interactive menus and selectable controls for all front-panel buttons and knobs. You must download the free advanced e*Scope software from the tektronix web site.

Help. Help takes you to the TDS3000B frequently asked questions site at www.tektronix.com.

NOTE. You can create your own local Applications and Help files and access them by changing the Application and Help field in the Configure menu to point to your local web site containing your files.

Application Examples

The following are some possible e*Scope usage examples:

Prototype Development. An engineering lab contains prototype boards that need evaluation. An engineer in the building can use e*Scope to access and remotely control a TDS3000B series oscilloscope to capture and download waveform data to a PC for analysis and inclusion in development reports.

Field Service Support. A company's central engineering department needs to support many field service technicians who maintain and repair installed systems located throughout the world. The field technicians can connect their TDS3000B series oscilloscopes to the systems, and the engineers can then use e*Scope to help the field technicians diagnose difficult problems.

Remote Line Down Troubleshooting. A production line is down in Korea. The chief engineer in the United States can use e*Scope to remotely control a TDS3000B series oscilloscope and view the waveforms to troubleshoot the problem, while having a technician at the production site probe the instrument.

Remote Broadcast Transmitter Monitoring. A television station needs to monitor various voltages and waveforms at a remote transmitter site. An engineer at the transmitter can connect the TDS3000B series oscilloscope to the station's LAN and then connect the oscilloscope to the appropriate test points. The television station engineer can then use e*Scope to remotely monitor the voltages and waveforms.

Remote Development. Several engineers on a project need to access waveform and measurement data from a number of remote sites. Using e*Scope, the engineers can capture screen hard copies and waveform data from these remote sites and store the information in a central database.



Appendices

Appendix A: Specifications

This appendix contains specifications for the TDS3000B Series oscilloscopes. All specifications are guaranteed unless noted as “typical.” Typical specifications are provided for your convenience but are not guaranteed. Specifications that are marked with the ✓ symbol are checked in *Appendix E: Performance Verification*.

All specifications apply to all TDS3000B Series models unless noted otherwise. To meet specifications, two conditions must first be met:

- The oscilloscope must have been operating continuously for twenty minutes within the operating temperature range specified.
- You must perform the Compensate Signal Path operation described on page 1-4. If the operating temperature changes by more than 10° C, you must perform the Compensate Signal Path operation again.

Specifications

Acquisition		
Acquisition modes	Sample (Normal), Peak detect, Envelope, and Average	
Single Sequence	<i>Acquisition mode</i>	<i>Acquisition stops after</i>
	Sample, Peak Detect	One acquisition, all channels simultaneously
	Average, Envelope	N acquisitions, all channels simultaneously, N is settable from 2 to 256 (or ∞ for Envelope)

Specifications (cont.)

Inputs		
Input coupling	DC, AC, or GND Channel input remains terminated when using GND coupling.	
Input impedance, DC coupled	1 M Ω \pm 1% in parallel with 13 pF \pm 2 pF, TekProbe compatible 50 Ω \pm 1%; VSWR \leq 1.5:1 from DC to 500 MHz, typical	
Maximum voltage at input BNC (1 M Ω)	<i>Overvoltage category</i>	<i>Maximum voltage</i>
	CAT I Environment (refer to page A-14)	150 V _{RMS} (400 V _{pk})
	CAT II Environment (refer to page A-14)	100 V _{RMS} (400 V _{pk})
	For steady-state sinusoidal waveforms, derate at 20 dB/decade above 200 kHz to 13 V _{pk} at 3 MHz and above.	
Maximum voltage at input BNC (50 Ω)	5 V _{RMS} with peaks \leq \pm 30 V	
Maximum floating voltage	0 V from chassis (BNC) ground to earth ground, or 30 V _{RMS} (42 V _{pk}) only under these conditions: no signal voltages >30 V _{RMS} (>42 V _{pk}), all common leads connected to the same voltage, no grounded peripherals attached	
Channel-to-channel crosstalk, typical	Measured on one channel, with test signal applied to another channel, and with the same scale and coupling settings on each channel	
	<i>Frequency range</i>	<i>Crosstalk</i>
	\leq 100 MHz	\geq 100:1
	\leq 200 MHz	\geq 50:1
	\leq 300 MHz	\geq 50:1
	\leq 400 MHz	\geq 30:1
	\leq 500 MHz	\geq 30:1
	\leq 600 MHz	\geq 30:1

Specifications (cont.)

Inputs				
Differential delay, typical	100 ps between any two channels with the same scale and coupling settings			
Vertical				
Number of channels	<i>TDS30x2B</i>		<i>TDS30x4B</i>	
	2 plus external trigger input		4 plus external trigger input	
Digitizers	9-bit resolution, separate digitizers for each channel, sampled simultaneously			
SCALE Range (at BNC)	1 M Ω		50 Ω	
	1 mV/div to 10 V/div		1 mV/div to 1 V/div	
Fine SCALE	Adjustable with $\geq 1\%$ resolution			
Polarity	Normal and Invert			
Position range	± 5 divisions			
✓ Analog bandwidth, 50 Ω (also typical at 1 M Ω with standard probe)	Bandwidth limit set to Full, operating ambient ≤ 30 °C, derate 1% / °C above 30 °C			
	<i>Scale range</i>	<i>5 mV/div to 1 V/div</i>	<i>2 mV/div to 4.98 mV/div</i>	<i>1 mV/div to 1.99 mV/div</i>
	TDS301xB	100 MHz	100 MHz	90 MHz
	TDS302xB	200 MHz	200 MHz	150 MHz
	TDS303xB	300 MHz	250 MHz	150 MHz
	TDS304xB	400 MHz	250 MHz	150 MHz
	TDS305xB	500 MHz ¹	300 MHz ¹	175 MHz ¹
	TDS306xB	600 MHz ^{1,2}	300 MHz ¹	175 MHz ¹
	Calculated rise time, typical	TDS301xB, TDS302xB		3.5 ns
TDS303xB, TDS304xB		1.2 ns		
TDS305xB, TDS306xB		0.7 ns		

¹ Values typical for 1 mV/div through 9.98 mV/div.

² 500 MHz at 5 mV/div to 9.98 mV/div; 600 MHz at 10 mV/div and greater.

Specifications (cont.)

Vertical			
Analog bandwidth limit, typical	Selectable between 20 MHz, 150 MHz (not available on TDS3012B or TDS3014B), or Full		
Lower frequency limit, AC coupled, typical	7 Hz for 1 M Ω , reduced by a factor of ten when using a 10X passive probe; 140 kHz for 50 Ω		
Peak detect or Envelope pulse response, typical	Minimum width of pulse with amplitude of ≥ 2 div to capture 50% or greater amplitude		
	<i>Sample rates ≤ 125 MS/s</i>	<i>Sample rates ≥ 250 MS/s</i>	
	1 ns	1/sample rate	
DC gain accuracy	$\pm 2\%$, derated at 0.025%/°C for temperatures below +18° C and above +30° C, in Sample or Average acquisition mode		
DC measurement accuracy	<i>Measurement type</i>	<i>DC Accuracy (in volts)</i>	
	Sample acquisition mode, typical	Absolute measurement of any waveform point	$\pm [0.02^2 \times \text{reading} - (\text{offset} - \text{position}) + \text{offset accuracy} + 0.15 \text{ div} + 0.6 \text{ mV}]$
		Delta voltage between any two points on a waveform	$\pm [0.02^2 \times \text{reading} + 0.15 \text{ div} + 1.2 \text{ mV}]$
✓ Average acquisition mode (≥ 16 averages)		Absolute measurement of any waveform point	$\pm [0.02^2 \times \text{reading} - (\text{offset} - \text{position}) + \text{offset accuracy} + 0.1 \text{ div}]$
		Delta voltage between any two points on a waveform	$\pm [0.02^2 \times \text{reading} + 0.05 \text{ div}]$

² 0.02 term (gain component) derated at 0.00025/°C above 30° C

Specifications (cont.)

Vertical				
Offset range	<i>Scale range</i>		<i>Offset range</i>	
	1 mV/div to 9.95 mV/div		±100 mV	
	10 mV/div to 99.5 mV/div		±1 V	
	100 mV/div to 995 mV/div		±10 V	
	1 V/div to 10 V/div		±100 V	
Offset Accuracy, all ranges	± [0.005 × offset - position +0.1 div] Note: Convert both the constant offset and position terms to volts by multiplying by the volts/div setting.			
Horizontal				
Acquisition (horizontal) resolution	<i>Normal</i> (10,000 point record)		<i>Fast trigger</i> (500 point record)	
	<i>TDS301xB,</i> <i>TDS302xB</i>	<i>TDS303xB-</i> <i>TDS306xB</i>	<i>TDS301xB,</i> <i>TDS302xB</i>	<i>TDS303xB-</i> <i>TDS306xB</i>
Maximum acq rate, typical	400 wfms/s	700 wfms/s	3,600 wfms/s	3,600 wfms/s
Sample rate range	<i>TDS301xB</i>	<i>TDS302xB,</i> <i>TDS303xB</i>	<i>TDS304xB-</i> <i>TDS306xB</i>	
	Normal	100 S/s to 1.25 GS/s	100 S/s to 2.5 GS/s	100 S/s to 5 GS/s
	Fast trigger	5 S/s to 1.25 GS/s	5 S/s to 2.5 GS/s	5 S/s to 5 GS/s
	Seconds/division range	4 ns/div to 10 s/div	2 ns/div to 10 s/div	1 ns/div to 10 s/div

Specifications (cont.)

Horizontal		
✓ Sample rate and delay time accuracy	±20 ppm over any ≥1 ms time interval	
Trigger		
External trigger input, typical	TDS30x2B: 1 MΩ in parallel with 17 pF, TekProbe compatible TDS30x4B: 1 MΩ in parallel with 52 pF, not Tekprobe compatible	
External trigger maximum voltage	<i>Overvoltage category</i>	<i>Maximum voltage</i>
	CAT I Environment (refer to page A-14)	150 V _{RMS} (400 V _{pk})
	CAT II Environment (refer to page A-14)	100 V _{RMS} (400 V _{pk})
	For steady-state sinusoidal waveforms, derate at 20 dB/decade above 200 kHz to 13 V _{pk} at 3 MHz and above.	
External trigger maximum floating voltage	0 V from chassis (BNC) ground to earth ground, or 30 V _{RMS} (42 V _{pk}) only under these conditions: no signal voltages >30 V _{RMS} (>42 V _{pk}), all common leads connected to the same voltage, no grounded peripherals attached	
✓ Edge trigger sensitivity	<i>Source</i>	<i>Sensitivity</i>
	Any channel, DC coupled	≤ 0.6 div from DC to 50 MHz, increasing to 1 div at oscilloscope bandwidth
Edge trigger sensitivity, typical	External trigger	200 mV from DC to 50 MHz, increasing to 750 mV at 300 MHz
	External/10 trigger	500 mV from DC to 50 MHz, increasing to 3 V at 300 MHz
	Any channel, NOISE REJ coupled	3.5 times the DC-coupled limits

Specifications (cont.)

Trigger		
Edge trigger sensitivity, typical	Any channel, HF REJ coupled	1.5 times the DC-coupled limit from DC to 30 kHz, attenuates signals above 30 kHz
	Any channel, LF REJ coupled	1.5 times the DC-coupled limits for frequencies above 80 kHz, attenuates signals below 80 kHz
Trigger level range	<i>Source</i>	<i>Sensitivity</i>
	Any channel	± 8 divisions from center of screen, ± 8 divisions from 0 V if LF REJ trigger coupled
	External trigger	± 800 mV
	External/10 trigger	± 8 V
	Line	Fixed at the midlevel of the AC line
SET LEVEL TO 50%, typical	Operates with input signals ≥ 45 Hz	
Trigger level accuracy, typical	<i>Source</i>	<i>Sensitivity</i>
	Any channel	± 0.2 divisions
	External trigger	± 20 mV
	External/10 trigger	± 200 mV
	Line	N/A
Trigger holdoff range	250.8 ns to 10 s	

Specifications (cont.)

Trigger		
Video trigger sensitivity, typical	Triggers on negative sync of NTSC, PAL, or SECAM signal	
	<i>Source</i>	<i>Sensitivity</i>
	Any channel	0.6 to 2.5 divisions of video sync tip
	External trigger	150 mV to 625 mV of video sync tip
	External/10 trigger	1.5 V to 6.25 V of video sync tip
B Trigger	<i>Trigger After Time</i>	<i>Trigger After B Events</i>
	Range	13.2 ns to 50 s
	Minimum time between arm and trigger, typical	5ns from the end of the time period and the B trigger event
	Minimum Pulse Width, typical	—
	Maximum Frequency, typical	—
		B event width, 2 ns
		B event frequency, 250 MHz

Specifications (cont.)

Display	
Display screen	6.5 in (165 mm) diagonal color liquid crystal
Display resolution	640 horizontal by 480 vertical pixels
Backlight intensity, typical	200 cd/m ²
Display color	Up to 16 colors, fixed palette
External display filter	Scratch-resistant tempered glass
I/O ports	
Ethernet port	10BaseT RJ-45 female connector (all models)
Parallel printer port	Centronics compatible, DB-25 female connector
GPIB interface	Available in optional accessory TDS3GV
RS-232 interface	DB-9 male connector, available in optional accessory TDS3GV
VGA signal output	DB-15 female connector, 31.6 kHz sync rate, EIA RS-343A compliant, available in optional accessory TDS3GV
Probe compensator output, typical	5.0 V into $\geq 1 \text{ M}\Omega$ load, frequency = 1 kHz
Miscellaneous	
Nonvolatile memory	Typical retention time ≥ 5 years for front-panel settings, unlimited for saved waveforms and setups
Floppy disk	3.5 in, DOS format, 720 KB or 1.44 MB compatible
Internal clock	Provides date/time stamp for stored data and the current time and date to the front panel, if enabled.

Specifications (cont.)

Power sources	
AC line power	Operates the oscilloscope and charges the optional internal battery
Source voltage	90 V _{RMS} to 250 V _{RMS} , continuous range
Source frequency	47 Hz to 440 Hz
Power consumption	75 W maximum
Battery power	Optional accessory TDS3BATB, rechargeable Li-Ion battery pack
Operating time, typical	3 hours, depending on operating conditions
Battery charge time, typical	30 hours in the oscilloscope, 5 hours in the optional external charger TDS3CHG
Line fuse	Internal, not user replaceable
Environmental	
Temperature	Operating range (no disk installed): +5 °C to +50 °C Nonoperating range (no disk installed): -20 °C to +60 °C Typical operating range for floppy disks: +10 °C to +50 °C
Humidity	Operating range (no disk installed): 20% to 80% RH below 32 °C, derate upper limit to 21% RH at 50 °C Nonoperating range (no disk installed): 5% to 90% RH below 41 °C, derate upper limit to 30% RH at 60 °C Typical operating range for floppy disks: 20% to 80% RH below 32 °C, derate upper limit to 21% RH at 50 °C
Pollution Degree	Pollution Degree 2: Typical home or office environment

Specifications (cont.)

Environmental	
Altitude	Operating limit: 3000 m Nonoperating limit: 15,000 m
Random vibration	Operating: 0.31 g _{RMS} from 5 Hz to 500 Hz, 10 minutes on each axis Nonoperating: 2.46 g _{RMS} from 5 Hz to 500 Hz, 10 minutes on each axis
Drop resistance, typical	Survives a 152 mm (6 in) drop onto concrete with only cosmetic damage
Mechanical	
Size	Height: 176 mm (6.9 in), 229 mm (9.0 in) including handle Width: 375 mm (14.75 in) Depth: 149 mm (5.9 in)
Weight	Oscilloscope only: 3.2 kg (7.0 lbs) With accessories and carry case: 4.1 kg (9.0 lbs) When packaged for domestic shipment: 5.5 kg (12.0 lbs) Optional TDS3BATB battery pack: 0.85 kg (1.9 lbs)

Specifications (cont.)

EMC certifications and compliances

<p>EMC Compliance: European Union</p>	<p>Meets the intent of Directive 89/336/EEC for Electromagnetic Compatibility. Compliance was demonstrated to the following specifications as listed in the Official Journal of the European Communities:</p> <p>EN 61326 EMC requirements for Class A electrical equipment for measurement, control, and laboratory use ^{1,2}</p> <p>IEC 61000-4-2 Electrostatic discharge immunity (Performance criterion B)</p> <p>IEC 61000-4-3 RF electromagnetic field immunity (Performance criterion B)³</p> <p>IEC 61000-4-4 Electrical fast transient/burst immunity (Performance criterion B)</p> <p>IEC 61000-4-5 Power line surge immunity (Performance criterion B)</p> <p>IEC 61000-4-6 Conducted RF immunity (Performance criterion B)⁴</p> <p>IEC 61000-4-11 Voltage dips and interruptions immunity (Performance criterion B)</p> <p>EN 61000-3-2 AC power line harmonic emissions</p> <p>EN 61000-3-3 Voltage changes, fluctuations and flicker</p>
---	---

Specifications (cont.)

EMC certifications and compliances	
EMC Compliance: Australia/New Zealand	Meets the intent of Australian EMC Framework as demonstrated to the following specification: AS/NZS 2064.1/2
EMC Compliance: Russia	This product was certified by the GOST ministry of Russia to be in compliance with all applicable EMC regulations.
FCC Compliance: U.S.A.	Emissions comply with FCC Code of Federal Regulations 47, Part 15, Subpart B, Class A Limits

- 1 Emissions that exceed the levels required by this standard may occur when this equipment is connected to a test object.
- 2 To ensure compliance to the standards listed above, attach only high quality shielded cables to this instrument. High quality shielded cables typically are braid and foil types that have low impedance connections to shielded connectors at both ends.
- 3 The increase in trace noise while subjected to a test field (3 V/m over the frequency range 80 MHz to 1 GHz, with 80% amplitude modulation at 1 kHz) is not to exceed 8 major divisions peak-to-peak. Ambient conducted fields may induce triggering when the trigger threshold is offset less than 4 major divisions from ground reference.
- 4 The increase in trace noise while subjected to a test field (3 V/m over the frequency range 150 kHz to 80 MHz, with 80% amplitude modulation at 1 kHz) is not to exceed 2 major divisions peak-to-peak. Ambient conducted fields may induce triggering when the trigger threshold is offset less than 1 major divisions from ground reference.

Specifications (cont.)

Safety certifications and compliances

<p>EC Declaration of Conformity - Low Voltage (TDS3000B Series, P3010, and P6139A) (P3010 and P6139A)</p>	<p>Compliance was demonstrated to the following specification as listed in the Official Journal of the European Communities: Low Voltage Directive 73/23/EEC as amended by 93/68/EEC EN 61010-1/A2:1995 Safety requirements for electrical equipment for measurement, control, and laboratory use EN 61010-2-031:1995 Particular requirements for hand-held probe assemblies for electrical measurement and test equipment</p>
<p>Approvals (TDS3000B Series, P3010, and P6139A) (P3010 and P6139A)</p>	<p>UL3111-1 - Standard for electrical measuring and test equipment CAN/CSA C22.2 No. 1010.1 - Safety requirements for electrical equipment for measurement, control and laboratory use EN 61010-2-031:1995 - Particular requirements for hand-held probe assemblies for electrical measurement and test equipment</p>
<p>Installation Category Descriptions</p>	<p>Terminals on this product may have different installation category designations. The installation categories are:</p> <p>CAT III Distribution-level mains (usually permanently connected). Equipment at this level is typically in a fixed industrial location</p> <p>CAT II Local-level mains (wall sockets). Equipment at this level includes appliances, portable tools, and similar products. Equipment is usually cord-connected</p> <p>CAT I Secondary (signal level) or battery operated circuits of electronic equipment</p>

Appendix B: Factory Setup

The table below lists the state of the oscilloscope after you recall the Factory Setup.

Control	Changed by factory setup to
Acquire horizontal resolution	Normal (10,000 points)
Acquire mode	Sample
Acquire number of averages	16
Acquire number of envelopes	16
Acquire run/stop	Run
Acquire single sequence	Off
Acquire WaveAlert actionsall	Off
Acquire WaveAlert sensitivity	50%
Acquire WaveAlert state	Off
Acquire WaveAlert type	Highlight entire waveform
Channel selection	Channel 1 on, all others off
Coarse	No change
Confirm delete	No change
Cursor function	Off
Cursor H Bar 1 position	-3.2 divisions from the center
Cursor H Bar 2 position	+3.2 divisions from the center
Cursor H Bar units	Base

Control	Changed by factory setup to
Cursor V Bar 1 position	10% of record
Cursor V Bar 2 position	90% of record
Cursor V Bar units	Seconds
Cursor tracking	Independent
Delay measure from waveform edge	Rising
Delay measure to edge occurrence	First
Delay measure to waveform	Ch 1
Delay measure to waveform edge	Rising
Display graticule type	Full
Display backlight	High
Display color palette	Normal
Display dots only	Off
Display persist time	Auto
Dual waveform math function	Ch 1 + Ch 2
Edge trigger coupling	DC
Edge trigger level	0.0 V
Edge trigger slope	Rising
Edge trigger source	Channel 1
External trigger probe setup (four-channel models only)	Voltage, 1X
Horizontal delay	On

Control	Changed by factory setup to
Horizontal delay time	0 ns
Horizontal trigger position	10%
Horizontal time/div	400 μ s/div
Horizontal zoom	Off
Horizontal zoom position	50%
Horizontal zoom time/div	400 μ s/div
Math type	Dual waveform
Measure gating	Off (Full Record)
Measure high-low setup	Auto
Measure high reference	90% and 0 V
Measure indicators	Off
Measure low reference	10% and 0 V
Measure mid reference	50% and 0 V
Measure mid2 reference	50% and 0 V
Measure statistics	Off
Overwrite lock	No change
Phase measure to waveform	Ch 1
Reference waveforms	No change
Saved setups	No change
Trigger holdoff	250.8 ns
Trigger mode	Auto
Trigger type	Edge

Control	Changed by factory setup to
Utility language	No change
Utility date/time display	On
Utility I/O	No change
Utility hard copy	No change
Vertical bandwidth	Full
Vertical coupling	DC 1 M Ω
Vertical invert	Off
Vertical offset	0 V
Vertical position	0 div
Vertical probe setup	Voltage, 1 X (unless non-1 X probe attached)
Vertical volts/div	100 mV/div
Video trigger standard	525/NTSC
Video trigger on	All lines
Waveform file format	No change
XY display	Off

Appendix C: Accessories

Standard Accessories

P3010 10X passive probes (TDS301xB)

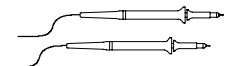

The P3010 10X passive probes have 100 MHz bandwidth and a CAT II voltage rating of 300 V_{RMS}.

P6139A 10X passive probes (TDS302xB - TDS306xB)

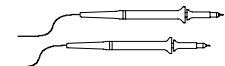

The P6139A 10X passive probes have 300 MHz or 500 MHz bandwidth and a CAT II voltage rating of 300 V_{RMS}.

Front cover

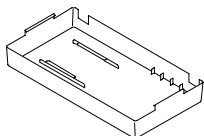

The front cover (200-4416-00) snaps onto the front of the oscilloscope to protect it during transit. The front cover contains a convenient location to store the Reference manual.

Accessory tray

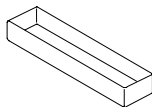

The accessory tray (436-0371-00) fits in the battery compartment when you do not have a battery installed. You can use the tray to store probes and other accessories.

Standard Accessories (cont.)

Manuals

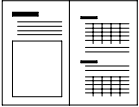

The oscilloscope includes a printed User and Reference manual. All TDS3000B product and optional accessory user manuals, in all supported languages, are available to download from the www.tektronix.com web site.

Optional Accessories

TDS3VID Extended Video application package



The extended video application package adds video trigger, video picture, vectorscope (vectorscope supports component video only), analog HDTV triggering, and measurement capabilities to your oscilloscope. Application packages can be installed by the user.

TDS3TMT Telecom Mask Test application package



The telecom mask test application package adds ITU-T G.703, ANSI T1.102 (up to DS3 data rates), and custom mask testing capabilities to your oscilloscope. Application packages can be installed by the user.

Optional Accessories (cont.)

TDS3SDI 601 Digital Video application package

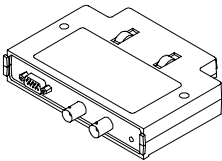

This application package adds 601 serial digital video to analog video conversion, video picture, vectorscope, and analog HDTV triggering capabilities to your oscilloscope. Application packages can be installed by the user.

TDS3AAM Advanced Analysis application package



The Advanced Analysis application package adds advanced math capabilities to your oscilloscope, including DPO math, arbitrary math expression waveforms, new measurements and measurement statistics, and FFT waveform analysis. Application packages can be installed by the user.

TDS3LIM Limit Test application package



The Limit Test application module adds custom waveform limit testing capabilities to your oscilloscope. Application packages can be installed by the user.

TDS3GV GPIB/RS-232/VGA communication module

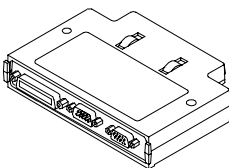

This communication module adds GPIB, RS-232, and VGA video ports to your oscilloscope. You can attach a printer to the GPIB or RS-232 ports, or use the ports for remote programmability. You can attach a monitor to the VGA port to enhance viewing the screen from a distance. Communication modules can be installed by the user and include a programmer manual.

NOTE: This module replaces the TDS3GM and TDS3VM modules, which are no longer manufactured. The TDS3GM and TDS3VM communication modules will operate in the TDS3000B Series oscilloscopes.

Optional Accessories (cont.)

TDS3CHG external battery charger

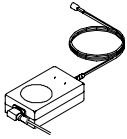

The battery charger recharges the oscilloscope battery pack in approximately 5 hours.

TDS3BATB rechargeable battery pack

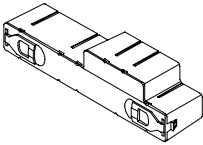

A rechargeable battery pack that provides up to three hours of portable operation.

TDS3PRT Thermal Printer

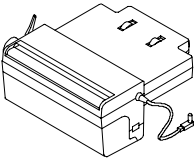

The TDS3PRT Thermal Printer is a plug-in oscilloscope-powered monochrome thermal printer that lets you print screen images.

Optional Accessories (cont.)

AC3000 soft case

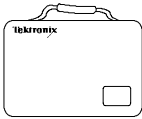

The soft case protects the oscilloscope when not in use. The soft case provides compartments for probes, one spare battery, battery charger, and the User Manual.

RM3000 rack mount kit

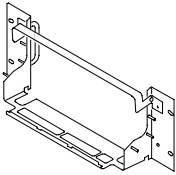

The rack mount kit contains all the hardware necessary to mount your oscilloscope in a standard rack. The kit requires 7 inches of vertical space in the rack.

WSTRO WaveStar Software for Oscilloscopes

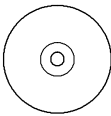

WaveStar is a Microsoft Office 97-compatible application that connects your oscilloscope to your PC. You can upload and download waveforms and setups. You can drag and drop acquired data into spreadsheets for further analysis, into word processors to integrate with your documentation, or to printers and plotters to make hard copies.

TDSPCS1 OpenChoice Solutions Software

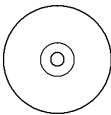

OpenChoice solutions deliver simple, seamless integration between your oscilloscope and your PC to easily capture, transfer, document, and analyze measurement results using popular PC-based applications.

Optional Accessories (cont.)

Manuals



The service manual (071-0972-XX) provides information about maintenance and module-level repair.

The programmer manual (071-0381-XX) provides information and a list of the oscilloscope control and query commands.

Appendix D: Probe Basics

This chapter contains basic information about the P3010 or P6139A probes provided with your oscilloscope. It also contains information about other probes you can use with your oscilloscope and their limitations.

Probe Descriptions

The P3010 and P6139A are high-impedance passive probes with the following general characteristics.

Characteristic	P3010	P6139A
Cable length	2 m	1.3 m
Compatibility	100 MHz oscilloscope models	200 MHz - 600 MHz oscilloscope models
Bandwidth	100 MHz	500 MHz
Attenuation	10X	10X
Nominal input impedance	10 M Ω in parallel with 13.3 pF	10 M Ω in parallel with 8 pF
Maximum working voltage	300 V, CAT II, derated at 20 dB/decade to 50 V above 2.5 MHz	300 V, CAT II, derated at 20 dB/decade to 50 V above 2.5 MHz
Altitude	3,000 m	2,000 m
Temperature Range		
Operating	-15 °C to +55 °C	-15 °C to +65 °C
Non Operating	-62 °C to +85 °C	-62 °C to +85 °C
Pollution Degree	2, Indoor use only	2, Indoor use only

Probe Compensation

You should compensate a probe to an oscilloscope input whenever you attach a probe for the first time to any input channel. See page 1-3 for instructions to compensate probes.

When compensating the P3010, only adjust the trimmer marked L.

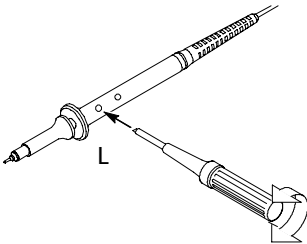

TekProbe Interface

Probes with the TekProbe interface automatically communicate with the oscilloscope to set the probe type and attenuation factor. If you use a probe without the TekProbe interface, you can set these parameters in the Vertical menu for the channel that the probe is connected to.

Probe Guard

A guard around the probe body provides a finger barrier for protection from electric shock.

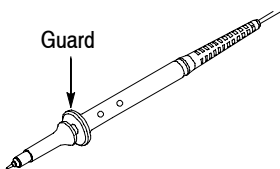

WARNING. To avoid electric shock when using the probe, keep fingers behind the guard on the probe body.

To avoid electric shock when using the probe, do not touch metallic portions of the probe head while connected to a voltage source.

Ground Leads

Always use a ground lead when you probe a circuit to minimize noise pickup and signal aberrations. Connecting the ground lead to a point near the signal source usually provides the best results.

Long ground leads can cause false ringing and aberrations in the acquired waveform that are not in the actual signal. To see the best signal fidelity, use the shortest possible ground lead.

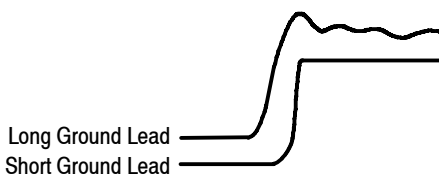

P3010 High-Frequency Compensation

The P3010 high-frequency compensation should seldom require adjustment; however, your probe may require high-frequency adjustment if either of the following are true:

- the probe has high-frequency aberrations
- the probe does not perform at the rated bandwidth

To perform the high-frequency compensation adjustment you will need a signal source that has all of the following characteristics:

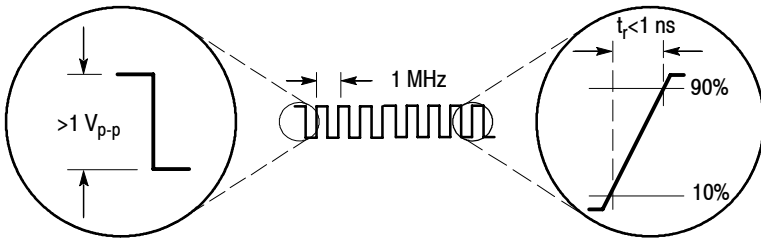

- square-wave output at 1 MHz
- fast rise output with rise time less than 1 ns
- output properly terminated

Connect the P3010 to the signal source to display a 1 MHz test signal on your oscilloscope. Use the BNC-to-probe tip adapter (013-0277-00) to make the connection. (The display should be similar to that shown below).

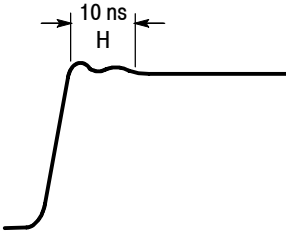

(a) Area Of Waveform Affected By Adjustment

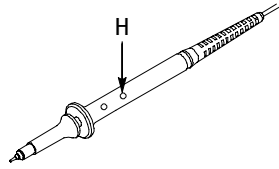

(b) Location of Adjustment

Adjust trimmer H until the waveform is flat on top and has a square leading edge.

P3010 Replaceable Parts and Accessories

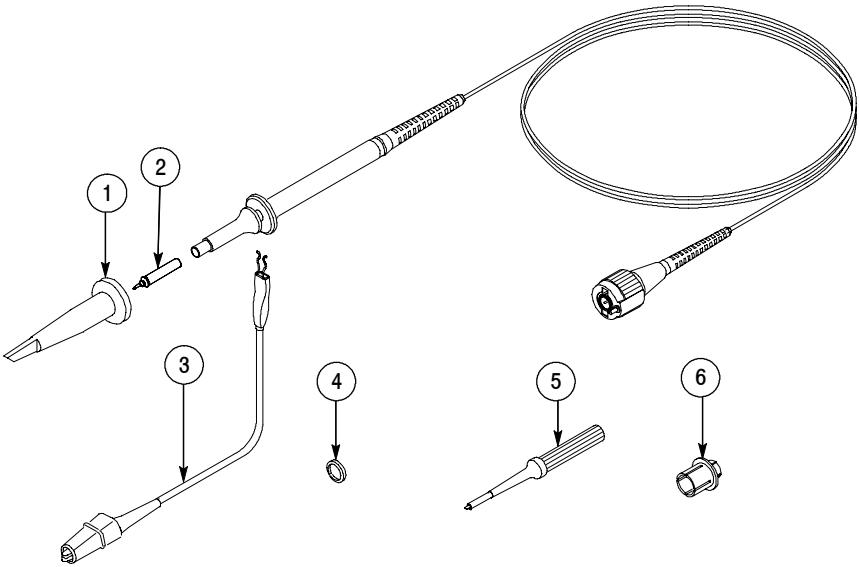

Standard Accessories

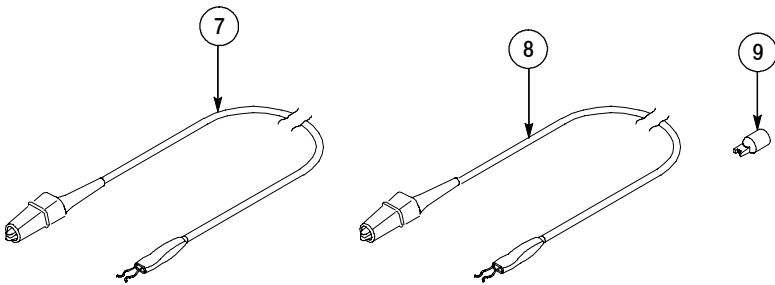

Optional Accessories

P3010 replaceable parts and accessories

Index number	Description	Part number
1	Retractable hook tip	013-0107-08
2	Probe tip	131-4997-01
3	Ground lead, 6 in	196-3120-01
4	Marker set (four colors, two each)	016-0633-00
5	Adjustment tool	003-1433-01
6	BNC-to-probe tip adapter	013-0277-00
7	Ground lead, 28 in	196-3120-21
8	Ground lead, 12 in	196-3121-01
9	IC test tip, package of 10	015-0201-07

P6139A Replaceable Parts and Accessories

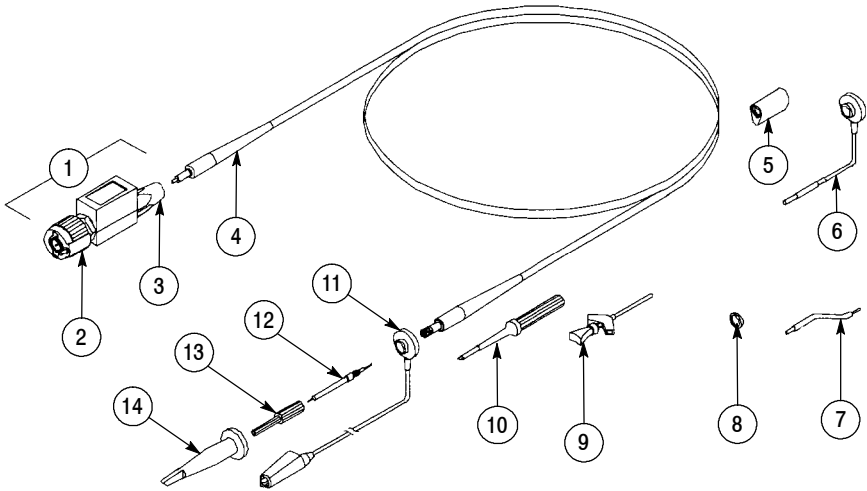

Standard Accessories

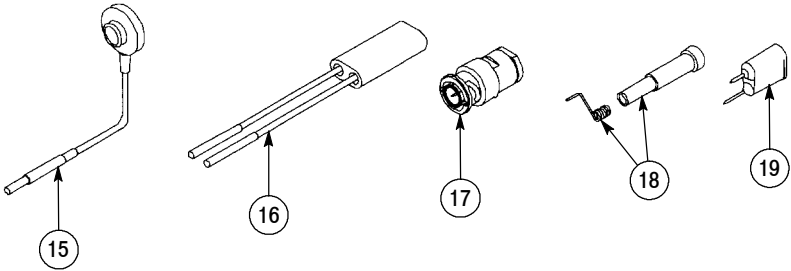

Optional Accessories

P6139A replaceable parts and accessories

Index number	Description	Part number
1	Compensation box assembly	206-0440-00
2	BNC connector	131-3219-00
3	Cable cover nipple	200-3018-00
4	Cable assembly	174-0978-00
5	Ground collar	343-1003-01
6	Ground lead, 6 in	196-3113-02
7	Ground lead, 2.3 in	195-4240-00
8	Marker set (four colors, two each)	016-0633-00
9	IC Klipchip grabber, package of 20	206-0364-00
01	Adjustment tool	003-1433-01
11	Ground lead with clip, 6 in	196-3305-00
12	Probe tip assembly	206-0441-00
13	Probe tip cover	204-1049-00
14	Retractable hook tip	013-0107-06
15	Ground lead, 3 in	196-3113-03
16	Probe to connector pin adapter	015-0325-00
17	50 Ω BNC-to-probe tip termination and adapter	013-0227-00
18	Ground contact kit (two each of five lengths) with cover shell	016-1077-00
19	Grounding probe tip	013-0085-00

Using Other Probes

Optional probes can add capabilities to your oscilloscope that are useful in many applications.

Passive Probes

You can use the following passive probes without any limitations.

Passive probe	Recommended usage
P6561A	SMT probe, 200 MHz, 10X
P6562A	SMT probe, 350 MHz, 10X
P6563A	SMT probe, 500 MHz, 20X
P5100	High-voltage probe, 2500 V _{pk} CAT II, 250 MHz, 100X
P6015A	High-voltage probe, 20 kV DC, 75 MHz, 1000X
P6021	Current probe, 15 A, 120 Hz to 60 MHz
P6022	Current probe, 6 A, 935 Hz to 120 MHz

Supported Active Probes and Adapters

The oscilloscope supplies power to active probes. You can use the following active probes as long as the total power required by the probes does not exceed the capacity of the oscilloscope. To determine the total probe load, add the load factors for all probes you want to use. The oscilloscope can supply power to this combination if the sum of the load factors equals 10 or less. All passive probes have a load factor of zero.

Active probe	Recommended usage	Load factor
P6205	FET probe, 750 MHz, 10X	0
P6243	SMT probe, 1 GHz, 10X	0
P5205	High-voltage differential probe, 1300 V, 100 MHz, 50X or 500X	6
P5210	High-voltage differential probe, 5600 V, 50 MHz, 100X or 1000X	6
ADA400A	Differential preamplifier, 10 μ V sensitivity, DC to 10 kHz	5
AFTDS	Telecom differential 50 Ω adapter	0
AMT75	Telecom 75 Ω adapter	0
TCP202	Current probe, 15 A, DC to 50 MHz	4
013-0278-00	Video display clamp	5



CAUTION. To avoid a measurement error, do not connect active probes with a combined load factor that is greater than 10. The signal distortion caused by such an overload can be subtle (reduced gain, dynamic range, or slew rate).

Unsupported Probes

The TDS3000B Series only supports the probes listed in this section of the manual. The oscilloscope may not display a message when you connect an unsupported probe, so make sure that any probe you connect to the TDS3000B is supported.



Appendix E: Performance Verification

Please refer to the *TDS3000B Digital Phosphor Oscilloscope Service Manual* (Tektronix part number 071-0972-XX) for performance verification procedures. You can download this manual from the Tektronix web site, www.tektronix.com.

Appendix F: General Care and Cleaning

General Care

Protect the oscilloscope from adverse weather conditions. The oscilloscope is not water resistant.

Do not store or leave the oscilloscope where the LCD display will be exposed to direct sunlight for long periods of time.



CAUTION. To avoid damage to the oscilloscope, do not expose it to sprays, liquids, or solvents.

Cleaning

Inspect the oscilloscope as often as operating conditions require. To clean the oscilloscope exterior, perform the following steps:

1. Remove loose dust on the outside of the oscilloscope with a lint-free cloth. Use care to avoid scratching the glass display filter.
2. Use a soft cloth or paper towel dampened with water to clean the oscilloscope. You can use a 75% isopropyl alcohol solution for more efficient cleaning.



CAUTION. To avoid damage to the surface of the oscilloscope, do not use any abrasive or chemical cleaning agents.

Appendix G: Ethernet Setup

The following sections describe how to set up the TDS3000B Series oscilloscope for network hard copy printing and remote programmability or access. The TDS3000B requires a straight-through 10BaseT cable with RJ-45 connector to connect to a LAN, or a crossover cable to connect to a PC equipped with an Ethernet card.

Your Ethernet Network Information

To connect the oscilloscope to the network, you must first obtain information from your network administrator. For your convenience, use the form on page G-15.

Make two photocopies of the form and send them to your network administrator to fill in. If you require remote access to the oscilloscope for programming or e*Scope access, then have the network administrator fill in section 1. If you require your oscilloscope to print screen hard copies to a network printer, then have the network administrator fill in sections 1 and 2. The administrator can then return one copy to you and keep the other copy.

NOTE. If the DHCP/BOOTP server assigns a dynamic IP address, then the value in the Instrument IP Address field may be different each time you power on the oscilloscope. This is not a problem if you are mostly sending hard copy to a network printer.

However, if you intend to remotely control or access the oscilloscope, have the system administrator assign a static IP address so that the oscilloscope IP address does not change. A static IP address makes it easier for remote devices to access a specific oscilloscope.

Entering the Ethernet Network Settings

The procedure for entering the oscilloscope Ethernet network parameters depends on your network configuration. If your network supports DHCP or BOOTP, then use the following procedure. If your network does not support DHCP or BOOTP, then use the procedure on page G-3.

Networks That Support DHCP and BOOTP

If your network supports DHCP/BOOTP, do these steps:

1. Push the **UTILITY** front panel button.
2. Push the **System** menu button to select **I/O**.
3. Push the **Ethernet Network Settings** screen button.
4. Push the **DHCP/BOOTP** side button to select **On**. The screen displays the clock icon while it is talking with the network to obtain an IP address for the oscilloscope. This step should only take a few moments, but the actual time will vary depending on your network. The clock icon disappears when the task is finished.

5. To verify that the network assigned an IP address to the oscilloscope, push the **Change Instrument Settings** side button to display the oscilloscope ethernet settings. The instrument IP address field should now be filled in.

If the instrument IP address field is blank, then the oscilloscope was not able to obtain an IP address from the network. Contact your network administrator for help, or use the procedure on page G-3 to manually enter the Ethernet settings.

Networks That Do Not Support DHCP and BOOTP

If your network does not support DHCP or BOOTP protocols, you will need to manually enter the oscilloscope network settings. To enter the Ethernet network settings information from section 1 of the form, do the following steps:

1. Push the **UTILITY** front panel button.
2. Push the **System** bottom button to select **I/O**.
3. Push the **Ethernet Network Settings** bottom button.
4. Push the **Change Instrument Settings** side button. The oscilloscope displays the Instrument Setup screen.
5. Use the Instrument Setup screen menu items and controls to enter the network settings information from section 1 of the form. See page G-8 for a description of the Instrument Setup screen.
6. If the form shows that DHCP or BOOTP are supported on your network, push the **DCHP/BOOTP** side button to select **On**.
7. When you are done entering the Ethernet network settings, push the **OK Accept** side button to store the settings in your instrument.

Entering the Network Printer Settings

To enter the Ethernet printer settings information from section 2 of the form into your oscilloscope, do the following steps:

1. Push the **UTILITY** front panel button.
2. Push the **System** bottom button to select **I/O**.
3. Push the **Ethernet Printer Settings** bottom button. The oscilloscope displays the Printer Configuration screen, which lists all network printers loaded into the oscilloscope.
4. Push the **Add Printer** side button. The oscilloscope displays the Add Printer screen.
5. Use the Add Printer screen menu items and controls to enter the network printer information from section 2 of the form. See page G-11 for a description of the Add Printer screen.

NOTE. If you have set the domain name and DNS IP address in the Ethernet Network Settings menu, then all you need to enter is the network printer's server name or the printer's server IP address in the Add Printer screen. The DNS server will look up the missing information.

6. When you are done entering the Ethernet printer settings, push the **OK Accept** side button to store the settings in your instrument. The oscilloscope returns you to the Printer Configuration screen, which lists the printer information you just entered. You can enter and store multiple network printer parameters.

Testing Your Ethernet Connection

The following text describes how to test the Ethernet connection, network printing, and the e*Scope feature. You must already have entered the oscilloscope Ethernet network and printer settings before doing these tests.

Testing the Oscilloscope Connection

To test your oscilloscope's Ethernet connection, do the following steps:

1. Push the **UTILITY** front panel button.
2. Push the **System** bottom button to select **I/O**.
3. Push the **Ethernet Network Settings** bottom button to display the Network Configuration side menu.
4. Push the **Test Connection** side button. If the connection is good, the side menu displays **OK**. If you do not see **OK**, go to page G-7 for troubleshooting suggestions.

Testing Network Printing

To test sending screen hard copy images to an Ethernet network printer, do the following steps:

1. On the oscilloscope, push **UTILITY > System : I/O > Ethernet Printer Settings**.
2. Select a network printer from the list.
3. Push the **System** bottom button to select **Hardcopy**.

4. Push the appropriate bottom and side menu buttons to select the correct settings for your network printer.
5. Push **MENU OFF** to clear the screen.
6. Push the **Hard Copy** button. The oscilloscope sends a hard copy screen image to the selected network printer. If the printer does not print the oscilloscope screen, go to page G-7 for troubleshooting suggestions.

Testing e*Scope

To use the e*Scope feature to test your oscilloscope's Ethernet connection, do the following steps:

1. On a PC or work station, open your preferred browser program.
2. In the Location or Address field (where you normally enter a URL), type in the IP address of the TDS3000B Series instrument to which you want to connect. For example, <http://188.121.212.107>. Do not precede the IP address with any characters (such as www).
3. Press the Return key. The browser program loads the instrument's e*Scope home page. If the e*Scope home page does not display, refer to page G-7 for troubleshooting suggestions.

Troubleshooting Your Ethernet Connection

If you are not able to remotely access the oscilloscope using e*Scope or programming commands, work with your system administrator to verify that:

- Your oscilloscope is physically connected to the network.
- Your oscilloscope network settings are correct.
- Your system administrator can “ping” the oscilloscope to verify that the instrument is electronically connected to the network.

If you are not able to send a hard copy to a network printer, work with your system administrator to verify that:

- You have set the oscilloscope to send hard copy output to the Ethernet port.
- You have set the hard copy file format to the correct format for your network printer.
- You have selected the correct printer in the Printer Configuration screen.
- The selected network printer is connected to the network and is online.
- The selected network printer server is running.

The Instrument Setup Screen

The following figure shows the Instrument Setup screen. The text that follows describes the screen menu items and controls for entering Ethernet network settings.

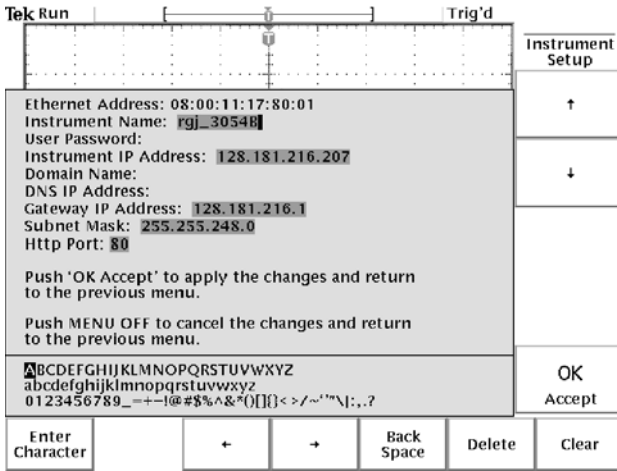

HTTP Port

The HTTP Port field sets the network http socket value for the oscilloscope. This field lets you set up the oscilloscope as an e*Scope web server on a port other than the default port 80. This is useful for avoiding conflicts with existing web servers that use the same IP address through a router. The default value is 80.

Instrument Setup Control	Description
General purpose knob	Selects (highlights) an alphanumeric character in the list.
Enter Character	Adds the selected alphanumeric character to the current network parameter field. You can also use the front panel SELECT button. The list of available characters changes depending on which field is selected.
← and →	Moves the cursor left or right in the current field.
Back Space	Erases the character to the left of the cursor.
Delete	Erases the character at the cursor position.
Clear	Clears (erases) the current field.
↑ and ↓	Selects a field to edit.
OK Accept	Closes the Instrument Setup screen and applies the network settings.
MENU OFF	Closes the Instrument Setup screen and returns you to the previous screen without applying changes.

The Printer Configuration Screen

The following figure shows the Printer Configuration screen.

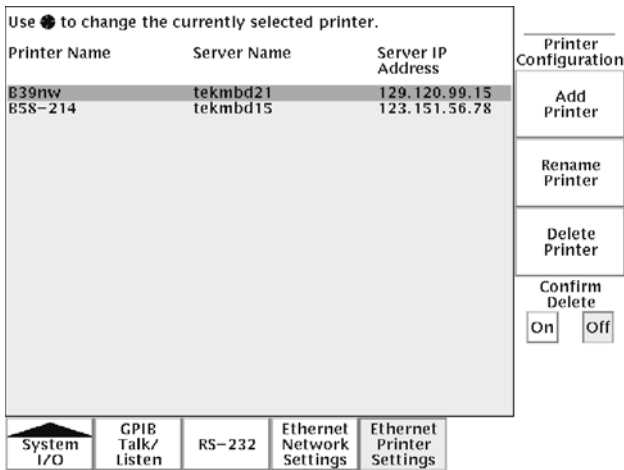

To select a network printer to which to send hard copy, use the general purpose knob to select (highlight) a printer. The oscilloscope uses the selected printer until you select a different printer.

To add a new printer, push the **Add Printer** side button. The oscilloscope displays the Add Printer screen, which is described on page G-11.

To rename an existing printer, select a printer and push the **Rename Printer** side button.

To delete a printer, select a printer and push the **Delete Printer** side button. If the **Confirm Delete** button is On, the oscilloscope asks you for confirmation before deleting the printer.

The Add Printer Screen

The following figure shows the Add Printer screen. The text that follows describes the screen menu items and controls for entering printer configuration settings.

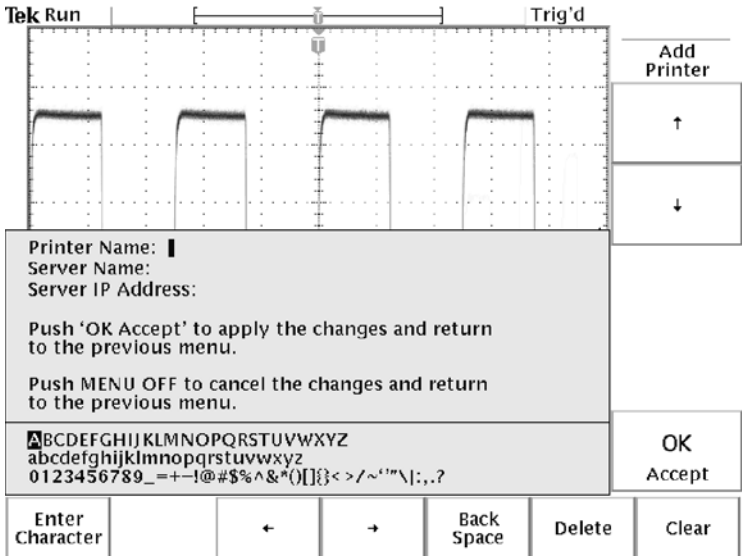

Add Printer Control	Description
General purpose knob	Selects (highlights) an alphanumeric character in the list.
Enter Character	Adds the selected alphanumeric character to the current printer setting field. You can also use the front panel SELECT button. The list of available characters changes depending on which field is selected.
← and →	Moves the cursor left or right in the current field.
Back Space	Erases the character to the left of the cursor.
Delete	Erases the character at the cursor position.
Clear	Clears (erases) the current field.
↑ and ↓	Selects a field to edit.
OK Accept	Closes the Add Printer screen and applies the printer settings. You can use the new printer immediately.
MENU OFF	Closes the Add Printer screen and returns you to the previous screen without applying changes.

Other Network Printer Settings

To verify that your oscilloscope is set to print to a network printer, do the following steps.

1. Select a network printer in the Ethernet printer list. You select a printer by using the general purpose knob to highlight a printer name in the list.
2. Push the **MENU OFF** button to exit from the System I/O menus.
3. Push **UTILITY > System** to select **Hard Copy**.
4. Push the **Format** bottom button and select the side button that is correct for your network printer.
5. Push the **Port** bottom button and select the **Ethernet** side button.
6. Set Inksaver to **ON** to print the oscilloscope screen as a black on white background image.
7. Push the **MENU OFF** button to exit from the System Hard Copy menus.

Testing Network Printers

To test that your oscilloscope is set to print to a network printer, push the Hard copy button. The printer should print the current screen to the selected network printer. If the printer does not print the screen, refer to page to page G-7 for troubleshooting suggestions.

Ethernet Error Messages

The following error messages can occur when you are having network problems. Read the text that follows to help rectify the problem.

Print Server Not Responding. This notifier displays when the oscilloscope attempts to send data to the selected network printer but the network refuses the connection to the network printer. This usually means that the network printer server is offline or the print server IP address is incorrect.

If DNS is available then you can verify the network print server data by entering the printer name and either (but not both) the print server name or the IP address. The DNS protocol will fill in the missing data if the user-supplied data is correct.

If DNS is not available, then contact your network administrator for help.

Printer Not Responding. This notifier displays when the oscilloscope attempts to send data to the selected network printer but the print server is unable to forward the data to the network printer. This usually means that the network printer is offline or the printer name is incorrect. Contact your network administrator to obtain the correct printer queue name.

DNS Server Not responding. This notifier displays when either the Domain information (Domain name or IP address) is not correct, or the print server name or printer server IP address is not validated (via the Domain Name Server).

Ethernet Settings Form

TDS3000B Ethernet Setup Form for _____

TDS3000B Ethernet Hardware address : : : : :
 (User: copy this address from the **UTILITY > System: I/O > Ethernet Network Settings > Change Instrument Setup** screen before sending this form to the network administrator)

Type of IP address requested: **Dynamic (DHCP/BOOTP)** **Static**
 (User: See page G-1 for information on dynamic and static IP addresses)

1

IP address settings (from network admin.):

Instrument Name _____
 Instrument (IP) Address _____
 Domain Name: _____
 DNS IP Address: _____
 Gateway IP Address: _____
 Subnet mask _____
 HTTP Port: _____

(User: Enter these values on the **UTILITY > I/O > Ethernet Network Settings > Change Instrument Settings** screen)

2

Network Administrator: Please provide network information about the following printer:

Printer Location: _____
 Printer Make: _____ Model: _____
 (User: fill in above printer information before sending form)

Printer Network Name: _____
 Printer Server Name: _____
 Print Server IP Address: _____

(User: Enter above information on the **UTILITY > I/O > Ethernet Printer Settings > Add Printer** screen.)



Glossary

Glossary

AC Coupling

A mode that blocks the DC component of a signal but passes the dynamic (AC) component of the signal. Useful for observing an AC signal that is normally riding on a DC signal.

Acquisition

The process of sampling signals from input channels, digitizing the samples, processing the results into data points, and assembling the data points into a waveform record. The waveform record is stored in memory.

Active Cursor

The cursor that moves when you adjust the general purpose knob. The @ readout on the display shows the position of the active cursor.

Aliasing

A false representation of a signal due to insufficient sampling of high frequencies or fast transitions. A condition that occurs when an oscilloscope digitizes at an effective sampling rate that is too slow to reproduce the input signal. The waveform displayed on the oscilloscope may have a lower frequency than the actual input signal.

Application Module

A small module that you plug in to the front panel to add capabilities to your oscilloscope. You can use up to four application modules at one time.

Application Package

An optional package that may include an application module, a firmware upgrade, and manuals that add capabilities to your oscilloscope.

Attenuation

The degree the amplitude of a signal is reduced when it passes through an attenuating device such as a probe or attenuator (the ratio of the input measure to the output measure). For example, a 10X probe attenuates, or reduces, the input voltage of a signal by a factor of 10.

Auto Trigger Mode

A trigger mode that causes the oscilloscope to automatically acquire if it does not detect a valid trigger event.

Autoset

A feature that automatically sets the vertical, horizontal, and trigger controls to provide a usable display.

Average Acquisition Mode

A mode in which the oscilloscope acquires and displays a waveform that is the averaged result of several acquisitions. The oscilloscope acquires data as in the sample mode and then averages it according to a specified number of averages. Averaging reduces uncorrelated noise in the displayed signal.

Backlight

The illumination behind the liquid-crystal display.

B Trigger

A second trigger system that works with the main (A) trigger to capture more complex events. You can use the dual A and B triggers to trigger after a given wait time or number of events.

Cursors

Paired markers that you can use to make measurements between two waveform locations. The oscilloscope displays the values (expressed in volts, time, or frequency) of the position of the active cursor and the distance between the two cursors.

DC Coupling

A mode that passes both AC and DC signal components to the circuit. Available for both the trigger system and the vertical system.

Communication Module

An optional module that adds I/O ports to the oscilloscope.

Delay

A means to delay the acquisition to start long after the trigger event has occurred. The trigger point does not have to be within the waveform record when delay is on.

Digital Phosphor

A term that describes the way the digitizing oscilloscope can simulate the acquisition behavior of an analog oscilloscope. Displayed points vary in intensity depending on the frequency of their acquisition and then decay as if the oscilloscope had an analog CRT (cathode ray tube).

Digital Real Time Digitizing

A digitizing technique that samples the input signal with a sample frequency of four to five times the oscilloscope bandwidth. Combined with $(\sin x)/x$ interpolation, all frequency components of the input up to the bandwidth are accurately displayed.

Digitizing

The process of converting a continuous analog signal such as a waveform to a set of discrete numbers representing the amplitude of the signal at specific points in time.

e*Scope™ Web-based Remote Control

A feature that lets you remotely access and control a TDS3000B Series oscilloscope over the Internet.

Edge Trigger

Triggering that occurs when the oscilloscope detects the source passing through a specified voltage level in a specified direction (the trigger slope).

Envelope Acquisition Mode

A mode in which the oscilloscope acquires and displays a waveform that shows the variation extremes of several acquisitions.

External Trigger

Triggering that occurs when the oscilloscope detects the external input signal passing through a specified voltage level in a specified direction (the trigger slope).

Floating Measurements

Voltage measurements where the reference voltage is not earth ground.

General Purpose Knob

A knob on the front panel that you can use to set parameters, for example, cursor position. The specific parameter assigned to the general purpose knob depends on other selections.

Gray Scale

The waveform display capable of showing points at different intensities, depending on the frequency of their occurrence. Color “gray scale” consists of light and dark shades of the color.

Ground (GND) Coupling

Coupling option that disconnects the input signal from the vertical system.

Ground Lead

The reference lead for an oscilloscope probe.

Ground Wire

A wire that must be connected between the ground terminal and earth ground when using the oscilloscope with battery power.

Hard Copy

An electronic copy of the display in a format useable by a printer or plotter.

Holdoff

A specified amount of time that must elapse after a trigger signal before the trigger circuit will accept another trigger signal. Holdoff helps ensure a stable display.

Horizontal Bar Cursors

The two horizontal bars that you position to measure the voltage parameters of a waveform. The oscilloscope displays the value of the active (moveable) cursor with respect to ground and the voltage value between the bars.

Menu

A set of labels shown in the display to identify the functions of the bezel buttons. The specific menu contents depend on the menu button you press.

Normal Trigger Mode

A mode where the oscilloscope does not acquire a waveform record unless a valid trigger event occurs. It waits for a valid trigger event before acquiring waveform data.

Peak Detect

An acquisition mode that captures spikes and glitches that may occur between normal sample points.

Persistence

The decay of waveform points. With persistence turned off, the points decay quickly. With persistence on, the points decay more slowly or not at all, depending on the setting.

Pixel

A visible point on the display. The display is 640 pixels wide by 480 pixels high.

Pretrigger

The specified portion of the waveform record that contains data acquired before the trigger event.

Preview

The oscilloscope capability to show you what the next acquisition might look like if you change control settings while acquisition is stopped or waiting for the next trigger. The new control settings take effect for the next acquisition. Both horizontal and vertical preview are available.

QuickMenu

An alternate display presentation that lets you control the most commonly used functions with the screen buttons. Optional application packages may have an available QuickMenu display.

Record Length

The specified number of samples in a waveform.

Reference Waveform

A saved waveform selected for display. You can save and display up to four reference waveforms.

Roll Mode

An acquisition mode useful at slow horizontal scale settings. Roll mode allows you to view the waveform as it is acquired point-by-point. The waveform appears to roll across the display.

RS-232

The serial communication port used to connect to a hard-copy device, computer, controller, or terminal.

Sample Acquisition Mode

A mode in which the oscilloscope creates a record point by saving the first sample during each acquisition interval. This is the default mode of the acquisition system.

Sample Interval

The time interval between successive samples in a time base. For real-time digitizers, the sample interval is the reciprocal of the sample rate.

Sampling

The process of capturing an analog input, such as a voltage, at a discrete point in time and holding it constant so that it can be quantized.

Scope QuickMenu

A built-in QuickMenu that places the most commonly used oscilloscope controls around the screen. With the Scope QuickMenu, you may not need to use the main menu system to operate the oscilloscope.

Screen Buttons

The rows of buttons below and to the right of the display that select items in the menus.

Selected Waveform

The waveform on which all measurements are performed and which is affected by vertical position and scale adjustments.

Signal Path Compensation (SPC)

The ability of the oscilloscope to minimize the electrical offsets in the vertical, horizontal, and trigger amplifiers caused by ambient temperature changes and component aging. You should run SPC when the ambient temperature varies more than 5° C from the last SPC or before performing critical measurements.

Single Sequence

A single shot acquisition if Sample or Peak-detect acquisition mode is selected. A series of N acquisitions if Average or Envelope acquisition mode is selected (N is the number of averages or envelopes).

Standby (STBY)

The off-like state when the instrument is not in use. Some circuits are active even while the instrument is in the standby state.

TekProbe Interface

An interface that communicates information between a probe and the oscilloscope, such as the probe type and its attenuation factor. The interface also supplies power to active probes.

Tek Secure

A feature that erases all waveform and setup memory locations (setup memories are replaced with the factory setup). Then it checks each location to verify erasure. This feature is useful where the oscilloscope is used to gather security-sensitive data.

Time Base

The set of parameters that let you define the time and horizontal axis attributes of a waveform record. The time base determines when and how long to acquire record points.

Vertical Bar Cursors

The two vertical bars you position to measure the time parameter of a waveform record. The oscilloscope displays the value of the active (moveable) cursor with respect to trigger and the time value between the bars.

Video Trigger

Triggering on the sync pulse of a composite video signal.

WaveAlert™ Waveform Anomaly Detection

A feature that lets you monitor steady-state waveforms and notify you when the oscilloscope detects a waveform anomaly. An anomaly is any waveform that differs significantly from the previously-acquired waveform.

XY Format

A display format that compares the voltage level of two waveform records point by point. It is useful for studying phase relationships between two waveforms.

YT Format

The conventional oscilloscope display format. It shows the voltage of a waveform record (on the vertical axis) as it varies over time (on the horizontal axis).

Zoom

The horizontal magnification capability of the oscilloscope. Zoom is a display function; adjusting zoom does not affect the acquired waveform.



Index

Index

A

- accessories, C-1
- acquisition
 - menu, 3-6
 - modes, 3-8
 - overview, 1-5
 - rate, 3-12
 - resolution, 3-12
 - single shot, 2-20, 3-3
 - status, 3-2
 - stopped, 3-2
 - waiting for trigger, 3-2
- active cursor, 3-18
- Address, Tektronix, xi
- adjusting probes, 1-3
- advanced analysis application
 - module, C-3
- alternating trigger, 3-67
- amplitude measurement, 3-44
- application modules
 - descriptions, C-2, C-3
 - installing, 1-17
- applications
 - autoset, 2-2
 - averaging, 2-11
 - cursors, 2-12
 - custom measurements, 2-6
 - delay, 2-13
 - examples, 2-1
 - gray scale, 2-19
 - measurements, 2-3, 2-5
 - measuring jitter, 2-15
 - peak detect, 2-10
 - video, 2-16
 - zoom, 2-22

AUTOSET

- button, 3-4
- undo, 3-4
- averaging, 3-8

B

- B TRIG button, 3-59
- B trigger, how to use, 3-59
- backlight
 - intensity, 3-23
 - timeout, 3-73
- bandwidth selection, 3-82
- battery
 - charging, 1-16, C-4
 - installation, 1-14
 - power, 1-12
 - recycling, viii
 - safety, 1-13
- burst width measurement, 3-44

C

- calibration, 1-4, 3-77
- cleaning, F-1
- clear spool, 3-29
- COARSE button, 3-18
- color
 - display, 3-25
 - printing, 3-29
- communication modules
 - description, C-2, C-3
 - installing, 1-19
- compressing hard copy files, 3-29
- constellation diagram, 3-26
- Contacting Tektronix, xi

cursors

- application example, 2-12
 - gating, 2-8, 3-42
 - interactions, 3-43
 - locating, 3-18, 3-22
 - measurements, 2-12
 - measurements when cursors at same position, 3-20
 - readouts, 3-19
 - tracking mode, 3-20
 - V Bars and FFT measurements, 3-20
 - XY cursor menu, 3-21
 - YT cursor menu, 3-16
- cycle mean measurement, 3-44
- cycle RMS measurement, 3-44

D

- date, setting, 1-4
- date/time, how to use, 3-72
- delay
- example application, 2-13
 - how to use, 3-33
 - interactions, 3-34, 3-37, 3-38
- DELAY button, 3-33
- delay measurement, 3-44
- deskew, probe, 3-82
- diagnostics, 3-78
- digital phosphor, 3-5
- disk drive
- application example, 2-23
 - how to use, 3-52

display

- colors, 3-25
- identifying items in, 1-27
- menu, 3-23
- overview, 1-7
- persistence, 3-25
- roll mode, 3-38
- slow horiz. settings, 3-37

E

- e*Scope, 3-88
- edge trigger, 3-64
- envelope, 3-8
- error log, 3-79
- ESD handling precautions, viii
- Ethernet, setup, *G-1*
- external trigger, 3-67

F

- factory calibration, 3-78
- factory setup, detailed description, B-1
- fall time measurement, 3-44
- fast trigger, 3-12
- file compression, hard copy, 3-29
- file system
- application example, 2-23
 - extensions, 3-57
 - formatting a disk, 3-56
 - how to use, 3-52
 - protections, 3-56
 - waveform data formats, 3-50
- firmware upgrade, 3-53
- FORCE TRIG button, 3-59
- frequency measurement, 3-44

front panel
 identifying connectors, 1-31
 identifying controls, 1-22
functional check, 1-2

G

gated xyz, 3-26
GPIB, 3-76
 communication module, C-2,
 C-3
gray scale
 application example, 2-19
 controlling, 3-5
 losing information, 3-36
 measurements, 3-19
 restrictions, 3-85, 3-87

H

hard copy. *See* printing
hard copy file compression, 3-29
high level measurement, 3-44
holdoff, 3-68
horizontal
 expansion marker, 3-32
 position, 3-31
 resolution, 3-12
 scale, 3-35
horizontal preview
 application example, 2-21
 interactions, 3-36
horizontal zoom
 application example, 2-22
 how to use, 3-35
 interactions, 3-36
 maximum, 3-36

I

I/O ports, 3-74
initial setup, 1-1
ink saver, 3-29

L

language, how to select, 3-71
limit test application module, C-3

M

magnify. *See* zoom
math
 preview, 3-85
 source waveform screen position,
 3-85
math waveform, 3-84
max measurement, 3-45
mean measurement, 3-45
measurements
 cursor, 2-12
 gating, 2-8, 3-42
 interactions, 3-41
 menu, 3-39
 reference levels, 2-7
 V Bars and FFT, 3-20
menus, how to use, 1-19
min measurement, 3-45

N

- negative measurement
 - duty cycle, 3-45
 - overshoot, 3-45
 - width, 3-45

P

- peak detect, 3-8
- peak-to-peak measurement, 3-45
- performance verification, E-1
- period measurement, 3-45
- persistence, 3-25
- phase measurement, 3-45
- Phone number, Tektronix, xi
- positive duty cycle measurement, 3-46
- positive overshoot measurement, 3-46
- positive width measurement, 3-46
- power
 - AC line, 1-11
 - battery, 1-12
 - probe, D-11
- power cord, 1-11
- power off timeout, 3-72
- pretrigger, 3-31
- preview
 - application example, 2-21
 - horizontal, 3-36
 - vertical, 3-83
- printing
 - color, 3-29
 - connections, 3-27
 - date/time stamp, 3-30
 - error message, 3-30
 - hard copy file compression, 3-29

- ink saver, 3-29
- preview, 3-29
- printer compatibility, 3-28
- spooler, 3-29
- probe compensation, 1-3
- probe deskew, 3-82
- probes
 - compensating, 1-3
 - general information, D-1
 - power limitations, D-11
 - safety information, D-3
- product description
 - accessories, C-1
 - models, 1-5
 - overview, 1-5
 - probes, D-10
- Product support, contact information, xi

Q

- QuickMenu, 1-29
 - how to use, 3-47
 - identifying menu items, 1-29

R

- readouts, cursors, 3-19
- rear panel, identifying connectors, 1-32
- record length, 3-12
- reference
 - scale and position, 3-85, 3-87
 - waveforms, 3-86
- remote control, e*Scope, 3-88
- removing waveforms, 3-80

rise time measurement, 3-46
RMS measurement, 3-46
roll mode, 3-38
RS-232
 communication module, C-2,
 C-3
 troubleshooting, 3-76
RUN/STOP button, 3-2

S

safety, battery operation, 1-13
sample, 3-8
save/recall
 menu, 3-48
 setups, 3-49
 waveforms, 3-86
 waveforms to file, 3-50
 waveforms to ref memory, 3-51
saved waveforms
 naming, 3-53
 printing, 3-55
SELECT button, 3-18
self test, 3-78
Service support, contact information, xi
SET TO 50% button, 3-58
signal path compensation, 1-4,
 3-77
signal processing, overview, 1-6
SINGLE SEQ button, 3-3
single shot, 3-3
 application example, 2-20
slow roll mode, 3-37
snapshot all measurements, 3-46
specifications, A-1
status
 acquisition, 3-2
 trigger, 3-63
stopped acquisition, 3-2

T

Technical support, contact information, xi
Tek Secure, how to use, 3-73
TekProbe interface, 3-82, D-2
Tektronix, contacting, xi
time base
 controlling, 3-35
 fast settings, 3-37
time, setting, 1-4
time-out, 3-72
trigger
 alternating, 3-67
 auto, 3-66
 edge, 3-64
 external, 3-67
 holdoff, 3-68
 level, 3-58
 menu, 3-58
 normal, 3-66
 position marker, 3-32
 status, 3-63
 video, 3-69
 XY waveforms, 3-25

U

undo autoset, 3-4
URL, Tektronix, xi
utility menus, 3-70

V

vertical

- menu, 3-81, 3-84, 3-86
- offset, 3-83
- position, 3-80
- preview, 3-83
- scale, 3-80

video modulation, application

- example, 2-19

video trigger, 3-69

- application example, 2-16
- sync pulse, 3-69

W

WaveAlert, 3-13

waveform, record icon, 1-28

WAVEFORM INTENSITY, 3-5

waveform off, 3-80

waveforms

- file formats, 3-57
- saving to file, 3-50
- saving to reference memory, 3-50

Web site address, Tektronix, xi

web-based remote control, 3-88

X

XY waveform

- controlling, 3-25
- gated xyz, 3-26
- restrictions, 3-26
- triggering, 3-25

XY, XYZ cursors, 3-21

Y

YT cursors, 3-16

Z

zoom

- application example, 2-22
- how to use, 3-35
- interactions, 3-36
- maximum, 3-36