

PROJECT MANUAL FOR:

# Campus Elevator Communications Installation

MONTANA STATE UNIVERSITY  
BOZEMAN, MONTANA

**October 31, 2022**

**PPA No. 21-0104**

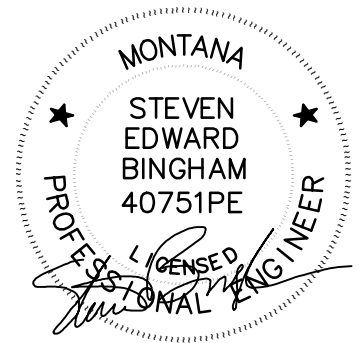

**MONTANA  
STATE UNIVERSITY**

UNIVERSITY FACILITIES MANAGEMENT  
BOZEMAN, MONTANA  
PHONE: (406) 994-5413 FAX: (406) 994-5665

**Cushing  
Terrell®**

316 N. Last Chance Gulch  
Helena, MT 59601  
P: 406.495.9400  
[www.cushingterrell.com](http://www.cushingterrell.com)

# TABLE OF CONTENTS

---

---

## BIDDING REQUIREMENTS

Permit Notice	
Invitation To Bid	
Instructions to Bidders	
Bid Proposal, Form 098 .....	

## CONTRACT DOCUMENTS

### **Included in this Project Manual:**

State of Montana General Conditions	MSU Supplemental Conditions
-------------------------------------	-----------------------------

The following documents to be used for construction are not included in the printed project manual.

These MSU Forms can be downloaded from our website:

<http://www.montana.edu/pdc/docs/index.html> – or will be provided upon request.

Substitution Request, Form 99	Certificate of Substantial Completion, Form 107
Schedule of Values for Payment, Form 100	Construction Change Directive, Form 109
Periodic Estimate for Partial Payment, Form 101	Request for Information, Form 111
Acknowledgement of Subcontractors, Form 102	Performance Bond, Form 112
Consent of Surety to Final Payment, Form 103	Labor and Material Payment Bond, Form 113
Contract Change Order, Form 104	Certificate of Final Acceptance, Form 118
Contractor's Affidavit, Form 106	Buy Safe Montana Form

**For most current Montana Prevailing Wage Rates applicable to this project download from this site:** <http://erd.dli.mt.gov/labor-standards/state-prevailing-wage-rates>

## TECHNICAL SPECIFICATIONS

Division 1 - General Requirements	
Summary .....	011000
Price and Payment Procedures .....	012000
Substitution Procedures .....	012500
Submittals .....	013000
Project Coordination .....	013100
Quality Requirements .....	014000
Temporary Facilities .....	015000
Product Requirements .....	016000
Executions .....	017300
Warranties Bonds .....	017400
Waste Management .....	017419
Project Closeout .....	017700
Operations & Maintenance Manuals .....	017823
Project Record Documents .....	017839
Demonstrations & Training .....	017900

## CONSTRUCTION DRAWINGS

Project Design Manual (Scope of Work)	
CS-1	COVER SHEET
DET-1	SCENARIO 1 CONNECTION DETAIL
DET-2	SCENARIO 2 CONNECTION DETAIL
DET-3	SCENARIO 3 CONNECTION DETAIL

DET-4	SCENARIO 4 CONNECTION DETAIL
DET-5	ONE-LINE CONNECTION DETAIL
DET-6	ONE-LINE CONNECTION DETAIL



## PERMIT NOTICE

At the time of Bidding, the City of Bozeman, Building Inspection Division, has determined that this project does not require building permits as the work is considered Repair and Maintenance. However, an **Electrical Permit is required**. Should the scope of the project change in the future, building permits may be required.

Bidders are encouraged to contact the City of Bozeman, Building Inspection Division, for further information regarding permits.

**CITY OF BOZEMAN  
BUILDING INSPECTION DIVISION  
20 EAST OLIVE STREET  
SUITE 208  
BOZEMAN, MONTANA 59715  
(406) 582-2375**

## INVITATION TO BID

Sealed bids will be received until **2:00 PM on Tuesday, November 22, 2022**, and will be publicly opened and read aloud in the offices of **MSU University Facilities Management, Plew Building, 6<sup>th</sup> & Grant, Bozeman, Montana**, for: **Campus Elevator Communications Installation, PPA No. 21-0104**.

Bids shall be submitted on the form provided within the Contract Documents. Contract documents may be obtained at the offices of:

**Montana State University**  
**UNIVERSITY FACILITIES MANAGEMENT**  
**Plew Building, 6<sup>th</sup> & Grant**  
**PO Box 172760**  
**Bozeman, Montana 59717-2760**

**On the web at:**  
<http://www.montana.edu/pdc/bids.html>

***A PRE-BID WALK-THROUGH CAN BE SCHEDULED UPON REQUEST. CONTACT MIKE REICH AT 406/994-6377.***

Bids must be accompanied by a bid security meeting the requirements of the State of Montana in the amount of 10% of the total bid. After award, the successful bidder must furnish an approved Performance Security and a Labor & Material Payment Security each in the amount of 100% of the contract for contracts equal to or greater than \$50,000.

No bidder may withdraw his bid for at least thirty (30) calendar days after the scheduled time for receipt of bids except as noted in the Instructions to Bidders.

The Owner reserves the right to reject any or all bids and to waive any and all irregularities or informalities and the right to determine what constitutes any and all irregularities or informalities.

### Time of Completion

Bidder agrees to commence work immediately upon receipt of the Notice to Proceed and to substantially complete the project **within One hundred twenty (120) consecutive days**.

*The State of Montana makes reasonable accommodations for any known disability that may interfere with an applicant's ability to compete in the bidding and/or selection process. In order for the state to make such accommodations, applicants must make known any needed accommodation to the individual project managers or agency contacts listed in the contract documents.*

State of Montana - Montana State University

## INSTRUCTIONS TO BIDDERS

1. Table of Contents

***Provided in the Printed Project Manual:***

Invitation to Bid  
 Instruction to Bidders  
 Bid Proposal, Form 098  
 Sample Standard Form of Contract  
 State of Montana General Conditions  
 MSU Supplementary Conditions  
 Specifications  
 Design Manual

Periodic Estimate for Partial Payment, Form 101  
 Acknowledgement of Subcontractors, Form 102  
 Consent of Surety to Final Payment, Form 103  
 Contract Change Order, Form 104  
 Contractor's Affidavit, Form 106  
 Certificate of Substantial Completion, Form 107  
 Construction Change Directive, Form 109  
 Request for Information, Form 111  
 Performance Bond, Form 112  
 Labor and Material Payment Bond, Form 113  
 Certificate of Final Acceptance, Form 118  
 Buy-Safe Montana Form

**These additional forms can be found on our website or will be provided upon request:**

<http://www.montana.edu/pdc/docs/index.html>

Substitution Request, Form 99  
 Schedule of Values, Form 100

**For most current Montana Prevailing Wage Rates applicable to this project download from this site: <http://erd.dli.mt.gov/labor-standards/state-prevailing-wage-rates>**

2. Viewing of Contract Documents

2.1. The Contract Documents may be viewed at the following locations:

Builders Exchange of Billings  
 2050 Broadwater STE A  
 Billings MT 59102  
 406/652-1311  
[bx@billingsplanroom.com](mailto:bx@billingsplanroom.com)

NW MT - Flathead Builders Exchange  
 2303 Hwy 2 E  
 Kalispell, MT 59901  
 406/755-5888  
[planex@kalcoply.com](mailto:planex@kalcoply.com)

Helena Plans Exchange  
 1530 Cedar Street Suite C  
 Helena MT 59601  
 406/457-2679  
[helenaplanex@helenacopycenter.com](mailto:helenaplanex@helenacopycenter.com)

Bozeman Builders Exchange  
 1105 Reeves RD W STE 800  
 Bozeman MT 59718  
 406/586-7653  
[exchange@bozemanplanroom.com](mailto:exchange@bozemanplanroom.com)

Great Falls Builders Exchange  
 202 2ND Avenue S  
 Great Falls MT 59401  
 406/453-2513  
[gfbe@greatfallsplans.com](mailto:gfbe@greatfallsplans.com)

Missoula Plans Exchange  
 201 N Russell ST  
 Missoula MT 59801  
 406/549-5002  
[mpe@vemcoinc.com](mailto:mpe@vemcoinc.com)

Butte Builders Exchange  
 4801 Hope Road  
 Butte MT 59701  
 406/782-5433  
[butteplans@gmail.com](mailto:butteplans@gmail.com)

3. Borrowing of Documents: Up to two hard copy sets may be obtained for General Contractors. Additionally, Contract Documents will be available electronically. If shipping of hard copies is required, it will be at the contractor's expense.

3.1. Contract Documents may be obtained at the office of:

**MONTANA STATE UNIVERSITY  
 UNIVERSITY FACILITIES MANAGEMENT  
 PLEW BUILDING 1st FLOOR  
 6TH AND GRANT  
 BOZEMAN, MONTANA 59717-2760  
 406/994-5413**

3.2. All borrowed Contract Documents shall be returned to University Facilities Management within ten (10) calendar days after the bid opening for the deposit refund (if deposit was required). However, if the Contract Documents are not in a condition where they can be reused by the Owner to construct the project, the Owner may at its sole discretion may retain the deposit or levy costs to contractor in order to

reproduce a replacement set.

4. Visits to Site

4.1. Prospective bidders are requested to contact the following for inspection of the site:

**Mike Reich, Project Manager  
Montana State University  
University Facilities Management  
6<sup>th</sup> and Grant, PO Box 172760  
Bozeman, Montana 59717-2760 Ph:  
406/994-6377; Fax: 406/994-5665**

4.2. Failure to visit site will not relieve the Contractor of the conditions of the contract.

5. Requests for Substitution

5.1 Any requests for product substitutions must be submitted on the "Substitution Request" Form 099, to the Architect/Engineer at least ten (10) days prior to the date of the bid opening for consideration by the Architect/Engineer. Any request for substitution made after this time restriction, including those made after award during project construction may be rejected without consideration by either the Architect/Engineer or the Owner.

6. Bids/Proposals

6.1. The bidder shall submit his bid on the Bid Proposal Form furnished with the Contract Documents.

6.2. DO NOT send the Contract Documents with the Proposal. The Contract Documents shall be returned as noted in Article 3.2 of the Instructions to Bidders.

6.3. If the project is funded by any portion of federal funds, the following may apply: on Federally-funded projects, a "Certification Regarding Debarment, Suspension, Ineligibility and Voluntary Exclusion" form must be submitted with the bid proposal. If the debarment form is not included within the Construction Documents, federal funds (if included) do not require the form or are not included in the project and the debarment form is not required.

6.4. Proposals shall be in a sealed envelope and addressed to:

**STATE OF MONTANA, MONTANA STATE UNIVERSITY  
UNIVERSITY FACILITIES MANAGEMENT  
PLEW BUILDING 1ST FLOOR  
6TH AND GRANT  
PO BOX 172760, BOZEMAN, MONTANA 59717-2760**

6.5. The envelope shall state that it contains a "BID PROPOSAL" and indicate the following information:

Name of Project:	<b>Campus Elevator Communications Installation</b>
Location:	<b>Montana State University Bozeman Campus</b>
MSU PPA Project Number:	<b>21-0104</b>
Name of Bidder:	_____
Acknowledge Addendum Number:	__, __, __, __

6.6. It is the bidder's responsibility to deliver or ensure delivery of the bid proposal to Montana State University, University Services. Proposals received after the scheduled closing time for bids by either the bidder, a delivery service (e.g. Federal Express, U.S. Postal Service, United Parcel Service, etc.), or the state's own mail delivery system, will be rejected. Proposals entitled for consideration must be time-stamped in the Owner's office prior to the closing time for receipt of bids. The official time clock for receipt of bids and fax modifications is the Owner's time and date stamp clock located in the reception area of the Owner's office. No other clocks, calendars or timepieces are recognized. All bidders are responsible to ensure all bids and fax modifications are received in the Owner's office prior to the scheduled closing time.

6.7. If requested on the Bid Proposal, any person making a bid to perform the Work shall, as a requirement of a responsible bid, set forth the name of each subcontractor specified in the "List of Subcontractors" which is part of the bid proposal. The bidder shall list only one subcontractor for each such portion or work listed. The bidder whose bid is accepted shall not:

- 6.7.1. Substitute any other subcontractor in place of the subcontractor listed in the original bid, except by specific consent of the Owner. The Owner, at its sole discretion, may grant substitution with consent of the originally listed subcontractor, or in consideration of other factor(s) involved if deemed relevant to the successful performance of the Contract.
- 6.7.2. Permit any such subcontract to be voluntarily assigned, transferred or allow it to be performed by any party other than the subcontractor listed in the original bid without the consent of the Owner.
- 6.8. Bid Proposals entitled to consideration shall be made in accordance with the following instructions:
  - 6.8.1. Made upon form provided;
  - 6.8.2. All blank spaces properly filled;
  - 6.8.3. All numbers stated in both writing and in figures;
  - 6.8.4. Shall contain no additions, conditional or alternate bids, erasures or other irregularities;
  - 6.8.5. Shall acknowledge receipt of all addenda issued.
- 6.9. Bid Proposals entitled to consideration shall be signed by the proper representative of the firm submitting the proposal as follows:
  - 6.9.1. The principal of a single owner firm;
  - 6.9.2. A principal of a partnership firm;
  - 6.9.3. An officer of an incorporated firm, or an agent whose signature is accompanied by a certified copy of the resolution of the Board of Directors authorizing that agent to sign; or,
  - 6.9.4. Other persons signing for a single-owner firm or a partnership shall attach a power-of-attorney evidencing his authority to sign for that firm.
- 6.10. Unit Prices: When a Bid Proposal Form contains unit prices, any errors discovered in the extension of those unit prices will be corrected by the Owner using the unit price figures. The adjusted extended amount will then be used to determine the correct total bid. Only after the amounts have been checked and adjusted, if necessary, will the valid low bid be determined.
- 6.11. Estimated Quantities: All estimated quantities stipulated in the Bid Proposal and other Contract Documents are approximate and are to be used only as a basis for estimating the probable cost of the work and for the purpose of comparing proposals submitted for the work. It is understood and agreed that the actual amounts of work done, and materials furnished under unit price items may vary from such estimated quantities. The actual quantities will depend on the conditions encountered at the time the work is performed.
- 6.12. Any bidder may modify his bid by fax communication only.
  - 6.12.1 It is the bidder's responsibility to ensure that the entire modification is received at the bid opening location prior to the scheduled closing time for receipt of bids. The modification shall not reveal the bid price but shall only provide the ADDITION or SUBTRACTION from the original proposal.
  - 6.12.2 The Owner is not responsible for the performance of the facsimile/printer machine, maintaining adequate paper levels, toner levels, the telephone connection, quality of the facsimile, or any other factors affecting receipt of the fax. Unreadable or difficult-to-read facsimiles may be rejected at the sole discretion of the Owner.
  - 6.12.3 Changes in the listed subcontractors, if any, shall also be provided.
  - 6.12.4 Bid modifications must be verified by hard copy provided to the Owner within two (2) business days after the bid opening.
  - 6.12.5 Bid modifications shall be directed to fax phone (406) 994-5665.
  - 6.12.6 All facsimiles shall be date and time stamped on the same time-stamp clock in the Owner's office that is used for receipt of bids in order to be considered valid. The Owner may also use the date and time on the automatically-generated email notification of facsimile receipt as generated by the State's system. Any date and time indicated at the top of the facsimile on either the bidder's or the Owner's facsimile/printer machine will not be used in determining time of arrival of the modification.
- 6.13. The Owner reserves the sole right to reject any or all bids and to waive any irregularities or informalities. The Owner also reserves the sole right to determine what constitutes irregularities or informalities and/or what is material and/or immaterial to the bids received.



7. Bid Security

- 7.1. IF THE PROJECT COST IS LESS THAN \$25,000, AT ITS SOLE DISCRETION THE STATE OF MONTANA MAY OR MAY NOT REQUIRE BID SECURITY (18-2-302 MCA).
- 7.2. All proposals shall be accompanied by a bid security in the amount of 10% of the bid price, as evidence of good faith (18-2-302 MCA). (**MSU does not waive bid security.**)
- 7.3. Bid security shall be in the form of lawful moneys of the United States, cashier's check, certified check, bank money order or bank draft, bid bond or bonds payable to the State of Montana (18-2-302 MCA).
- 7.4. If the bidder, to whom a contract is awarded, fails to enter into and execute the proposed contract within fifteen (15) calendar days of award, the bidder shall forfeit the bid security (18-1-204 MCA).
- 7.5. The bid security of unsuccessful bidders will be returned when the contract has been awarded to the successful bidder or when all bids have been rejected (18-1-205 MCA).
- 7.6. Execution of and entering into a contract includes providing all necessary insurance certificates, bonds, signed contract and current copy of the construction contractor registration certificate.
- 7.7. **NOTE: PER STATE POLICY, IF CASH, CHECK, MONEY ORDER, OR BANK DRAFT ARE PROVIDED AS BID SECURITY, IT WILL BE DEPOSITED IN THE TREASURY. UNSUCCESSFUL BIDDERS WILL HAVE THEIR SECURITY RETURNED UPON CONTRACT AWARD. THE SUCCESSFUL BIDDER'S SECURITY MAY BE RETURNED UPON ISSUANCE OF NOTICE TO PROCEED.**

8. Withdrawal of Bids

- 8.1. Any bidder may withdraw his bid proposal at any time prior to the scheduled closing time for the receipt of bids.
- 8.2. Once the closing time for the receipt of bids is reached, a bid may not be withdrawn for a period of thirty (30) calendar days.

9. Interpretation of Contract Documents

- 9.1. Bidders shall promptly notify the Architect/Engineer of any ambiguity, inconsistency, or error which they may discover upon examination of the Contract Documents or of the site and local conditions.
- 9.2. Bidders requiring clarification or interpretation of the Contract Documents shall request, in writing, clarification from the Architect/Engineer at least ten (10) calendar days prior to the date set for receipt of bids.
- 9.3. Any interpretations, corrections, or change in the Contract Documents prior to the bid opening will be made by written addendum issued by the Architect/Engineer. The Architect/Engineer will endeavor to notify all plan holders of any addenda issued but it shall be the responsibility of the individual bidders to insure they have received all addenda prior to the submission of their bid.
- 9.4. All written addenda issued by the Architect/Engineer will become part of the Contract Documents and all bidders shall be bound by such addenda whether or not received and/or acknowledged by the bidder. No oral or telephone modifications of the Contract Documents will be considered or allowed.

10. Award of Bids

- 10.1. All bids received by the stated hour will be opened and publicly read aloud.
- 10.2. The Owner reserves the right to reject any and all bids and to waive any informality or irregularity in any bid received. Owner reserves the right to determine what constitutes material and/or immaterial informalities and/or irregularities.
- 10.3. The low bid shall be determined on the basis of the lowest Base Bid or the lowest combination of Base Bid and Alternate Bids, accepted in consecutive order.
- 10.4. The Owner shall award such contract to the lowest responsible bidder (18-1-102 MCA).

- 10.4.1. The Owner may make such investigations as it deems necessary to determine whether or not any or all bidders are responsible.
  - 10.4.2. The term “responsible” does not refer to pecuniary ability only, nor the ability to tender sufficient performance and payment bonds.
  - 10.4.3. The term “responsible” includes, but is not limited to:
    - 10.4.3.1. Having adequate financial resources to perform the contract or the ability to obtain them;
    - 10.4.3.2. Being able to comply with the required delivery, duration, and performance schedule;
    - 10.4.3.3. Having a satisfactory record of integrity and business ethics;
    - 10.4.3.4. Having the necessary organization, experience, accounting, and operational controls;
    - 10.4.3.5. Having the necessary production, construction, technical equipment, and facilities; and,
    - 10.4.3.6. Having the technical skill, ability, capacity, integrity, performance, experience, lack of claims and disputes, lack of actions on bonds, lack of mediations, arbitrations and/or lawsuits related to construction work or performance, and such like.
  - 10.4.4. Bidders shall furnish to the Owner all information and data for this purpose as the Owner may request.
  - 10.4.5. The Owner reserves the right to reject any bid if the investigation or evidence of any Bidder fails to satisfy the Owner that such Bidder is properly and adequately qualified to suitably perform and satisfactorily execute the obligations of the Contract and Work defined in the Contract Documents.
- 10.5. The Owner shall award such contract to the lowest responsible bidder without regard to residency except on a reciprocal basis: a resident bidder will be allowed a preference on a contract against the bid of any non-resident bidder from any state or country that enforces a preference for resident bidders. The preference given to resident bidders of the State of Montana must be equal to the preference given in the other state or country (18-1-102, MCA). This does not apply when prohibited by Federal requirements.
- 10.6. The State of Montana may negotiate deductive changes, not to exceed 7% of the total cost of the project, with the lowest responsible bidder when the lowest responsible bids causes the project cost to exceed the appropriation; or with the lowest responsible bidders if multiple contracts will be awarded on the projects when the total of the lowest responsible bids causes the project cost to exceed the appropriation. A bidder is not required to negotiate his bid but is required to honor his bid for the time specified in the bidding documents. The Owner may terminate negotiations at any time (18-2-105(7) MCA).
11. Contract
- 11.1. The sample Standard Form of Contract between Contractor and Owner, as issued by the Owner, will be used as the contracting instrument and is bound within the Contract Documents.
  - 11.2. The form shall be signed by a proper representative of the bidder as defined above in these instructions.
  - 11.3. The contractor shall also complete and return a federal form W-9 with the Contract.
12. Performance, Labor and Material Payment Security
- 12.1. IF THE PROJECT COST IS LESS THAN \$25,000, AT ITS SOLE DISCRETION THE STATE OF MONTANA MAY OR MAY NOT REQUIRE A PERFORMANCE OR LABOR AND MATERIAL PAYMENT SECURITY (18-2-201 MCA). **(MSU REQUIRES BONDS ON ALL PROJECTS ABOVE \$50,000.)**
  - 12.2. THE CONTRACTOR SHALL PROVIDE BOTH SECURITIES FOR THIS PROJECT AS SPECIFIED BELOW, UNLESS SPECIFICALLY DIRECTED THAT THIS REQUIREMENT HAS BEEN WAIVED ELSEWHERE IN THESE DOCUMENTS.
  - 12.3. The Owner shall require the successful bidder to furnish a Performance Bond in the amount of 100% of the contract price as security for the faithful performance of his contract (18-2-201, MCA).
  - 12.4. The Owner shall require the successful bidder to furnish a Labor and Material Payment Bond in the amount of 100% of the contract price as security for the payment of all persons performing labor and furnishing materials in connection therewith (18-2-201 MCA).

- 12.5. The bonds shall be executed on forms furnished by the Owner. No other forms will be acceptable.
- 12.6. The bonds shall be signed in compliance with State statutes (33-17-111 MCA).
- 12.7. Bonds shall be secured from a State licensed bonding company.
- 12.8. Power of Attorney
  - 12.8.1. Attorneys-in-fact who sign contract bonds must file with each bond a certified and effectively dated copy of their power of attorney;
  - 12.8.2. One original copy shall be furnished with each set of bonds.
  - 12.8.3. Others furnished with a set of bonds may be copies of that original.
13. Notice To Proceed
  - 13.1. The successful bidder who is awarded the contract for construction will not be issued a Notice to Proceed until there is a signed Contract, the specified insurance certificates and a copy of the bidder's current Construction Contractor Registration Certificate in the Owner's possession. All items are required within fifteen (15) calendar days of contract award made by the Owner.
14. Laws and Regulations
  - 14.1. The bidders' attention is directed to the fact that all applicable federal and state laws, municipal ordinances, and the rules and regulations of all authorities having jurisdiction over the project shall apply to the contract throughout and will be deemed to be included in this contract as if bound herein in full.
15. Payments
  - 15.1. NOTICE OF APPROVAL OF PAYMENT REQUEST PROVISION. Per Title 28, Chapter 2, Part 21, this contract allows the Owner to change the number of days to approve a Contractor's payment request. This contract allows the Owner to approve the Contractor's payment request within thirty-five (35) calendar days after it is received by the Owner without being subject to the accrual of interest.
16. Buy Safe Montana Provisions
  - 16.1. The successful bidder who is awarded the contract for construction shall provide their incident rate, experience modification ratio (EMR) and loss ratio via the Buy-Safe Montana form with the Award documents.
17. Time of Completion
  - 17.1. Bidder agrees to commence work immediately upon receipt of the Notice to Proceed and to substantially complete the project **within one hundred twenty (120) consecutive days**.
  - 17.2. Actual damages may be assessed pursuant to the General Conditions. The Contractor acknowledges and understands that the Owner may suffer loss for every day of delay Final Acceptance is not achieved. Nothing contained in this waiver of liquidated damages shall be deemed to preclude an award of actual damages in accordance with Paragraphs 4.3 through 4.6 of the General Conditions of the Contract for Construction.

~END OF INSTRUCTIONS~



UNIVERSITY FACILITIES MANAGEMENT

Sixth Avenue and Grant Street • P.O. Box 172760 • Bozeman, Montana 59717-2760
Phone: (406) 994-5413 • Fax: (406) 994-5665

BID PROPOSAL

Elevator Communications Upgrades
PPA No. 21-0104

TO:
State of Montana, Montana State University
University Facilities Management
Attn: Contract Administrator
Plew Building, 6th & Grant, PO Box 172760
Bozeman, Montana 59717-2760

Prospective Bidders:

The undersigned, having familiarized themselves with the Contract Documents, site, location, and conditions of the Work as prepared by CUSHING TERRELL, 316 N Last Chance Gulch, Helena, MT, 59601, 406/495-9400, or UNIVERSITY FACILITIES MANAGEMENT by submission of this Bid Proposal, hereby agrees to provide all materials, systems, equipment and labor necessary to complete the Work for the total sum as follows:

BASE BID:

\_\_\_\_\_ and \_\_\_\_ /100 DOLLARS.
(ALPHA notation) \$ \_\_\_\_\_ (NUMERIC notation)

This bidder acknowledges receipt of the following addenda:

ADDENDUM No.: \_\_\_\_\_ Dated: \_\_\_\_\_
ADDENDUM No.: \_\_\_\_\_ Dated: \_\_\_\_\_
ADDENDUM No.: \_\_\_\_\_ Dated: \_\_\_\_\_

By signing below, the bidder agrees to all terms specified and AGREES TO fulfill the requirements of the CONTRACT in strict accordance with the bidding documents.

Company Name: \_\_\_\_\_

Signature\*\*: \_\_\_\_\_

Print Name: \_\_\_\_\_

Title: \_\_\_\_\_

Business Address: \_\_\_\_\_

Construction Contractor
Registration No.: \_\_\_\_\_

Phone No.: \_\_\_\_\_

Fax No.: \_\_\_\_\_

Email: \_\_\_\_\_

Date: \_\_\_\_\_

\*\* Must meet the requirements of paragraph 6.9 of the Project Manual.

MONTANA  
PREVAILING WAGE RATES FOR BUILDING CONSTRUCTION SERVICES 2022

**Effective: January 1, 2022**

*Greg Gianforte, Governor  
State of Montana*

*Laurie Esau, Commissioner  
Department of Labor & Industry*

To obtain copies of prevailing wage rate schedules, or for information relating to public works projects and payment of prevailing wage rates, visit ERD at [erd.dli.mt.gov/labor-standards](http://erd.dli.mt.gov/labor-standards) or contact:

Employment Relations Division  
Montana Department of Labor and Industry  
P. O. Box 8011  
Helena, MT 59620-1503  
Phone 406-444-6543

**The department welcomes questions, comments, and suggestions from the public. In addition, we'll do our best to provide information in an accessible format, upon request, in compliance with the Americans with Disabilities Act.**

#### **MONTANA PREVAILING WAGE REQUIREMENTS**

The Commissioner of the Department of Labor and Industry, in accordance with Sections 18-2-401 and 18-2-402 of the Montana Code Annotated (MCA), has determined the standard prevailing rate of wages for the occupations listed in this publication.

The wages specified herein control the prevailing rate of wages for the purposes of Section 18-2-401, et seq., MCA. It is required each employer pay (as a minimum) the rate of wages, including fringe benefits, travel allowance, zone pay and per diem applicable to the district in which the work is being performed as provided in the attached wage determinations.

All Montana Prevailing Wage Rates are available on the internet at [erd.dli.mt.gov/labor-standards](http://erd.dli.mt.gov/labor-standards) or by contacting the department at (406) 444-6543.

In addition, this publication provides general information concerning compliance with Montana's Prevailing Wage Law and the payment of prevailing wages. For detailed compliance information relating to public works contracts and payment of prevailing wage rates, please consult the regulations on the internet at [erd.dli.mt.gov/labor-standards](http://erd.dli.mt.gov/labor-standards) or contact the department at (406) 444-6543.

LAURIE ESAU  
Commissioner  
Department of Labor and Industry  
State of Montana

## TABLE OF CONTENTS

### MONTANA PREVAILING WAGE REQUIREMENTS:

A. Date of Publication .....	3
B. Definition of Building Construction .....	3
C. Definition of Public Works Contract .....	3
D. Prevailing Wage Schedule .....	3
E. Rates to Use for Projects .....	3
F. Wage Rate Adjustments for Multiyear Contracts .....	3
G. Fringe Benefits .....	4
H. Prevailing Wage Districts .....	4
I. Dispatch City .....	5
J. Zone Pay .....	5
K. Computing Travel Benefits .....	5
L. Per Diem .....	5
M. Apprentices .....	5
N. Posting Notice of Prevailing Wages .....	5
O. Employment Preference .....	5
P. Projects of a Mixed Nature .....	6
Q. Occupations Definitions Website .....	6
R. Welder Rates .....	6
S. Foreman Rates .....	6

### WAGE RATES:

BOILERMAKERS .....	7
BRICK, BLOCK, AND STONE MASONS .....	7
CARPENTERS .....	7
CARPET INTALLERS .....	8
CEMENT MASONS AND CONCRETE FINISHERS .....	8
CONSTRUCTION EQUIPMENT OPERATORS .....	8
OPERATORS GROUP 1 .....	9
OPERATORS GROUP 2 .....	9
OPERATORS GROUP 3 .....	10
OPERATORS GROUP 4 .....	10
OPERATORS GROUP 5 .....	10
OPERATORS GROUP 6 .....	10
OPERATORS GROUP 7 .....	11
CONSTRUCTION LABORERS .....	11
LABORERS GROUP 1 .....	11
LABORERS GROUP 2 .....	12
LABORERS GROUP 3 .....	12
LABORERS GROUP 4 .....	12
DRYWALL APPLICATORS .....	12
ELECTRICIANS: INCLUDING BUILDING AUTOMATION CONTROL .....	13
ELEVATOR CONSTRUCTORS .....	13
FLOOR LAYERS .....	14
GLAZIERS .....	14
HEATING AND AIR CONDITIONING .....	14
INSULATION WORKERS - MECHANICAL (HEAT AND FROST) .....	15
IRONWORKERS - STRUCTURAL STEEL AND REBAR PLACERS .....	15
MILLWRIGHTS .....	15
PAINTERS: INCLUDING PAPERHANGERS .....	16
PILE BUCKS .....	16
PLASTERERS .....	16
PLUMBERS, PIPEFITTERS, AND STEAMFITTERS .....	17
ROOFERS .....	18
SHEET METAL WORKERS .....	18
SOLAR PHOTOVOLTAIC INSTALLERS .....	19
SPRINKLER FITTERS .....	20
TAPERS .....	20
TELECOMMUNICATIONS EQUIPMENT INSTALLERS .....	20
TERRAZZO WORKERS AND FINISHERS .....	21
TILE AND STONE SETTERS .....	21
TRUCK DRIVERS .....	21

## **A. Date of Publication January 1 2022**

## **B. Definition of Building Construction**

For the purposes of Prevailing Wage, the Commissioner of Labor and Industry has determined that building construction occupations are defined to be those performed by a person engaged in a recognized trade or craft, or any skilled, semi-skilled, or unskilled manual labor related to the construction, alteration, or repair of a public building or facility, and does not include engineering, superintendence, management, office or clerical work.

The Administrative Rules of Montana (ARM), 24.17.501(2) – 2(a), states *“Building construction projects generally are the constructions of sheltered enclosures with walk-in access for housing persons, machinery, equipment, or supplies. It includes all construction of such structures, incidental installation of utilities and equipment, both above and below grade level, as well as incidental grading, utilities and paving.”*

*Examples of building construction include, but are not limited to, alterations and additions to buildings, apartment buildings (5 stories and above), arenas (closed), auditoriums, automobile parking garages, banks and financial buildings, barracks, churches, city halls, civic centers, commercial buildings, court houses, detention facilities, dormitories, farm buildings, fire stations, hospitals, hotels, industrial buildings, institutional buildings, libraries, mausoleums, motels, museums, nursing and convalescent facilities, office buildings, out-patient clinics, passenger and freight terminal buildings, police stations, post offices, power plants, prefabricated buildings, remodeling buildings, renovating buildings, repairing buildings, restaurants, schools, service stations, shopping centers, stores, subway stations, theaters, warehouses, water and sewage treatment plants (buildings only), etc.”*

## **C. Definition of Public Works Contract**

Section 18-2-401(11)(a), MCA defines “public works contract” as *“...a contract for construction services let by the state, county, municipality, school district, or political subdivision or for nonconstruction services let by the state, county, municipality, or political subdivision in which the total cost of the contract is in excess of \$25,000...”*.

## **D. Prevailing Wage Schedule**

This publication covers only Building Construction occupations and rates. These rates will remain in effect until superseded by a more current publication. Current prevailing wage rate schedules for Heavy Construction, Highway Construction, and Nonconstruction Services occupations can be found on the internet at <https://erd.dli.mt.gov/labor-standards/> or by contacting the department at (406) 444-6543.

## **E. Rates to Use for Projects**

ARM, 24.17.127(1)(c), states *“The wage rates applicable to a particular public works project are those in effect at the time the bid specifications are advertised.”*

## **F. Wage Rate Adjustments for Multiyear Contracts**

Section 18-2-417, MCA states:

*“(1) Any public works contract that by the terms of the original contract calls for more than 30 months to fully perform must include a provision to adjust, as provided in subsection (2), the standard prevailing rate of wages to be paid to the workers performing the contract.*

*(2) The standard prevailing rate of wages paid to workers under a contract subject to this section must be adjusted 12 months after the date of the award of the public works contract. The amount of the adjustment must be a 3% increase. The adjustment must be made and applied every 12 months for the term of the contract.*

*(3) Any increase in the standard rate of prevailing wages for workers under this section is the sole responsibility of the contractor and any subcontractors and not the contracting agency.”*

## G. Fringe Benefits

Section 18-2-412, MCA states:

*“(1) To fulfill the obligation...a contractor or subcontractor may:*

*(a) pay the amount of fringe benefits and the basic hourly rate of pay that is part of the standard prevailing rate of wages directly to the worker or employee in cash;*

*(b) make an irrevocable contribution to a trustee or a third person pursuant to a fringe benefit fund, plan, or program that meets the requirements of the Employee Retirement Income Security Act of 1974 or that is a bona fide program approved by the U. S. department of labor; or*

*(c) make payments using any combination of methods set forth in subsections (1)(a) and (1)(b) so that the aggregate of payments and contributions is not less than the standard prevailing rate of wages, including fringe benefits and travel allowances, applicable to the district for the particular type of work being performed.*

*(2) The fringe benefit fund, plan, or program described in subsection (1)(b) must provide benefits to workers or employees for health care, pensions on retirement or death, life insurance, disability and sickness insurance, or bona fide programs that meet the requirements of the Employee Retirement Income Security Act of 1974 or that are approved by the U. S. department of labor.”*

Fringe benefits are paid for all hours worked (straight time and overtime hours). However, fringe benefits are not to be considered a part of the hourly rate of pay for calculating overtime, unless there is a collectively bargained agreement in effect that specifies otherwise.

## H. Prevailing Wage Districts

Montana counties are aggregated into 4 districts for the purpose of prevailing wage. The prevailing wage districts are composed of the following counties:

### Montana Prevailing Wage Districts

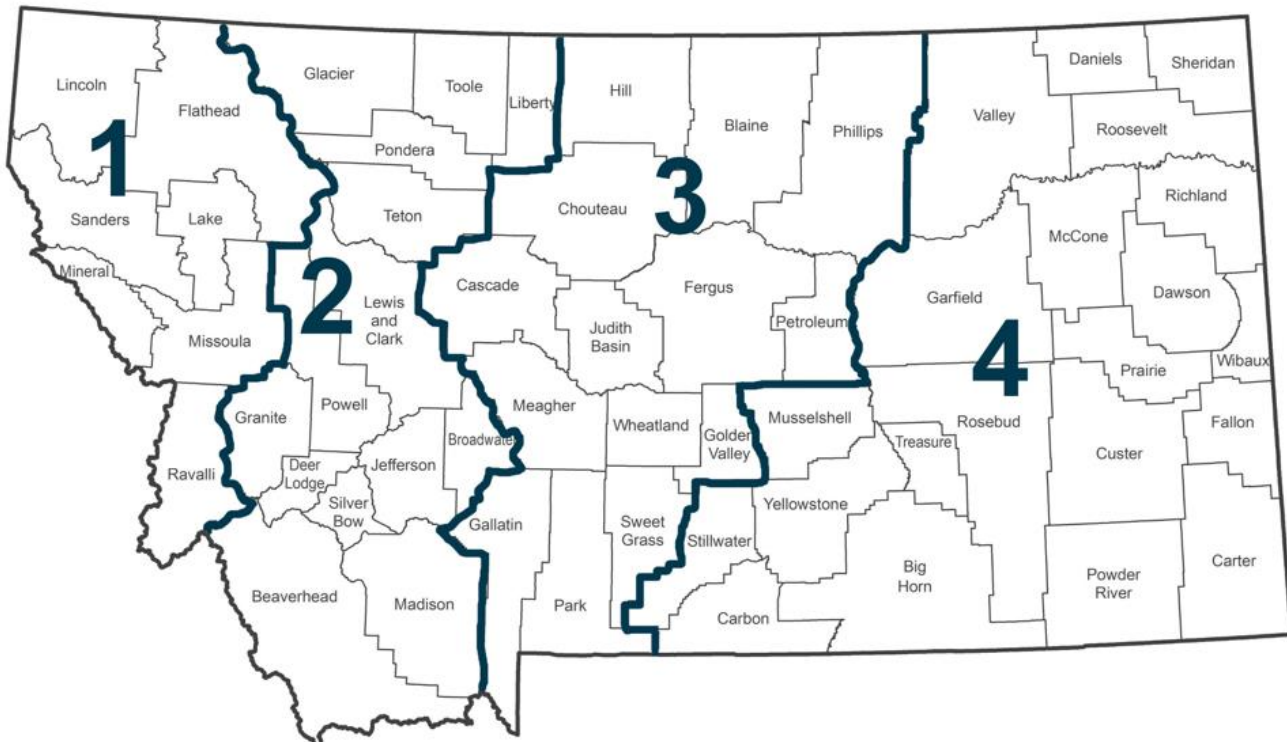



## **I. Dispatch City**

ARM, 24.17.103(11), defines dispatch city as “...the courthouse in the city from the following list which is closest to the center of the job: Billings, Bozeman, Butte, Great Falls, Helena, Kalispell, Miles City, Missoula and Sidney.” A dispatch city shall be considered the point of origin only for jobs within the counties identified in that district (as shown below):

**District 1 – Kalispell and Missoula:** includes Flathead, Lake, Lincoln, Mineral, Missoula, Ravalli, and Sanders;

**District 2 – Butte and Helena:** includes Beaverhead, Broadwater, Deer Lodge, Glacier, Granite, Jefferson, Lewis and Clark, Liberty, Madison, Pondera, Powell, Silver Bow, Teton, and Toole;

**District 3 – Bozeman and Great Falls:** includes Blaine, Cascade, Chouteau, Fergus, Gallatin, Golden Valley, Hill, Judith Basin, Meagher, Park, Petroleum, Phillips, Sweet Grass, and Wheatland;

**District 4 – Billings, Miles City and Sidney:** includes Big Horn, Carbon, Carter, Custer, Daniels, Dawson, Fallon, Garfield, McCone, Musselshell, Powder River, Prairie, Richland, Roosevelt, Rosebud, Sheridan, Stillwater, Treasure, Valley, Wibaux, and Yellowstone.

## **J. Zone Pay**

Zone pay is not travel pay. ARM, 24.17.103(24), defines zone pay as “...an amount added to the base pay; the combined sum then becomes the new base wage rate to be paid for all hours worked on the project. Zone pay must be determined by measuring the road miles one way over the shortest practical maintained route from the dispatch city to the center of the job.” See section I above for a list of dispatch cities.

## **K. Computing Travel Benefits**

ARM, 24.17.103(22), states “ ‘Travel pay,’ also referred to as ‘travel allowance,’ is and must be paid for travel both to and from the job site, except those with special provisions listed under the classification. The rate is determined by measuring the road miles one direction over the shortest practical maintained route from the dispatch city or the employee’s home, whichever is closer, to the center of the job.” See section I above for a list of dispatch cities.

## **L. Per Diem**

ARM, 24.17.103(18), states “ ‘Per diem’ typically covers costs associated with board and lodging expenses. Per diem is paid when an employee is required to work at a location outside the daily commuting distance and is required to stay at that location overnight or longer.”

## **M. Apprentices**

Wage rates for apprentices registered in approved federal or state apprenticeship programs are contained in those programs. Additionally, Section 18-2-416(2), MCA states “...The full amount of any applicable fringe benefits must be paid to the apprentice while the apprentice is working on the public works contract.” Apprentices not registered in approved federal or state apprenticeship programs will be paid the appropriate journey level prevailing wage rate when working on a public works contract.

## **N. Posting Notice of Prevailing Wages**

Section 18-2-406, MCA provides that contractors, subcontractors and employers who are “...performing work or providing construction services under public works contracts, as provided in this part, shall post in a prominent and accessible site on the project or staging area, not later than the first day of work and continuing for the entire duration of the project, a legible statement of all wages and fringe benefits to be paid to the employees.”

## **O. Employment Preference**

Sections 18-2-403 and 18-2-409, MCA requires contractors to give preference to the employment of bona fide Montana residents in the performance of work on public works contracts.

## **P. Projects of a Mixed Nature**

Section 18-2-418, MCA states:

*“(1) The contracting agency shall determine, based on the preponderance of labor hours to be worked, whether the public works construction services project is classified as a highway construction project, a heavy construction project, or a building construction project.*

*“(2) Once the project has been classified, employees in each trade classification who are working on that project must be paid at the rate for that project classification”*

## **Q. Occupations Definitions**

You can find definitions for these occupations on the following Bureau of Labor Statistics website:

<https://erd.dli.mt.gov/labor-standards/state-prevailing-wage-rates/building-construction-occupations>

## **R. Welder Rates**

Welders receive the rate prescribed for the craft performing an operation to which welding is incidental.

## **S. Foreman Rates**

Rates are no longer set for foremen. However, if a foreman performs journey level work, the foreman must be paid at least the journey level rate.

# WAGE RATES

## BOILERMAKERS

	<b>Wage</b>	<b>Benefit</b>
District 1	\$34.12	\$31.68
District 2	\$34.12	\$31.68
District 3	\$34.12	\$31.68
District 4	\$34.12	\$31.68

### **Duties Include:**

Construct, assemble, maintain, and repair stationary steam boilers, boiler house auxiliaries, process vessels, and pressure vessels.

### **Travel:**

#### **All Districts**

0-120 mi. free zone  
>120 mi. federal mileage rate/mi.

### **Special Provision:**

Travel is paid only at the beginning and end of the job.

### **Per Diem:**

#### **All Districts**

0-70 mi. free zone  
>70-120 mi. \$65.00/day  
>120 mi. \$80.00/day

[↑ Back to Table of Contents](#)

## BRICK, BLOCK, AND STONE MASONS

	<b>Wage</b>	<b>Benefit</b>
District 1	\$31.38	\$16.32
District 2	\$31.38	\$16.32
District 3	\$31.38	\$16.32
District 4	\$31.38	\$16.32

### **Travel:**

#### **All Districts**

0-70 mi. free zone  
>70-90 mi. \$60.00/day  
>90 mi. \$80.00/day

[↑ Back to Table of Contents](#)

## CARPENTERS

	<b>Wage</b>	<b>Benefit</b>
District 1	\$25.73	\$11.44
District 2	\$25.75	\$14.11
District 3	\$27.39	\$13.82
District 4	\$25.75	\$13.82

### **Zone Pay:**

#### **All Districts**

0-30 mi. free zone  
>30-60 mi. base pay + \$4.00/hr.  
>60 mi. base pay + \$6.00/hr.

### **Duties Include:**

Install roll and batt insulation, and hardwood floors.

[↑ Back to Table of Contents](#)

## CARPET INSTALLERS

### No Rate Established

#### Duties Include:

Lay and install carpet from rolls or blocks on floors. Install padding and trim flooring materials.

[↑ Back to Table of Contents](#)

### Travel and Per Diem:

#### All Districts

No travel or per diem established.

## CEMENT MASONS AND CONCRETE FINISHERS

	<b>Wage</b>	<b>Benefit</b>
District 1	\$24.44	\$5.74
District 2	\$24.44	\$5.74
District 3	\$24.23	\$6.23
District 4	\$24.23	\$6.23

#### Duties Include:

Smooth and finish surfaces of poured concrete, such as floors, walks, sidewalks, or curbs. Align forms for sidewalks, curbs, or gutters. Rates for rebar workers can be found under the Ironworkers classification.

[↑ Back to Table of Contents](#)

### Travel and Per Diem:

#### All Districts

No travel or per diem established

## CONSTRUCTION EQUIPMENT OPERATORS GROUP 1

	<b>Wage</b>	<b>Benefit</b>
District 1	\$27.91	\$12.70
District 2	\$27.91	\$12.70
District 3	\$27.91	\$12.70
District 4	\$27.91	\$12.70

#### This group includes but is not limited to:

Air Compressor; Auto Fine Grader; Belt Finishing; Boring Machine (Small) 12 inch and under; Cement Silo; Crane, A-Frame Truck Crane; Crusher Conveyor; DW-10, 15, and 20 Tractor Roller; Farm Tractor; Forklift; Form Grader; Front-End Loader, under 1 cu. yd; Oiler, Heavy Duty Drills; Herman Nelson Heater; Mucking Machine; Oiler, All Except Cranes/Shovels; Pumpman.

[↑ Back to Table of Contents](#)

### Zone Pay:

#### All Districts

0-30 mi. free zone

>30-60 mi. base pay + \$3.50/hr.

>60 mi. base pay + \$5.50/hr.

## CONSTRUCTION EQUIPMENT OPERATORS GROUP 2

	<b>Wage</b>	<b>Benefit</b>
District 1	\$28.70	\$12.70
District 2	\$26.50	\$10.67
District 3	\$28.70	\$13.55
District 4	\$28.70	\$12.70

### **This group includes but is not limited to:**

Air Doctor; Backhoe\Excavator\Shovel, up to and incl. 3 cu. yds; Bit Grinder; Bituminous Paving Travel Plant; Boring Machine, Large; Broom, Self-Propelled; Concrete Travel Batcher; Concrete Float & Spreader; Concrete Bucket Dispatcher; Concrete Finish Machine; Concrete Conveyor; Distributor; Dozer, Rubber-Tired, Push, & Side Boom; Elevating Grader\Gradall; Field Equipment Serviceman; Front-End Loader, 1 cu. yd up to and incl. 5 cu. yds; Grade Setter; Heavy Duty Drills, All Types; Hoist\Tugger, All; Hydralift Forklifts & Similar; Industrial Locomotive; Motor Patrol (except finish); Mountain Skidder; Oiler, Cranes\Shovels; Pavement Breaker, EMSCO; Power Saw, Self-Propelled; Pugmill; Pumpcrete\Grout Machine; Punch Truck; Roller, other than Asphalt; Roller, Sheepsfoot (Self-Propelled); Roller, 25 tons and over; Ross Carrier; Rotomill, under 6 ft; Trenching Machine; Washing /Screening Plant.

[↑ Back to Table of Contents](#)

### **Zone Pay:**

#### **All Districts**

0-30 mi. free zone

>30-60 mi. base pay + \$3.50/hr.

>60 mi. base pay + \$5.50/hr.

## CONSTRUCTION EQUIPMENT OPERATORS GROUP 3

	<b>Wage</b>	<b>Benefit</b>
District 1	\$29.45	\$12.70
District 2	\$29.45	\$12.70
District 3	\$25.97	\$ 9.04
District 4	\$29.45	\$12.70

### **This group includes but is not limited to:**

Asphalt Paving Machine; Asphalt Screed; Backhoe\Excavator\Shovel, over 3 cu. yds; Cableway Highline; Concrete Batch Plant; Concrete Curing Machine; Concrete Pump; Cranes, Creter; Cranes, Electric Overhead; Cranes, 24 tons and under; Curb Machine\Slip Form Paver; Finish Dozer; Front-End Loader, over 5 cu. yds; Mechanic\Welder; Pioneer Dozer; Roller Asphalt (Breakdown & Finish); Rotomill, over 6 ft; Scraper, Single, Twin, or Pulling Belly-Dump; YO-YO Cat Haul Truck, Articulating Trucks, Vac Truck.

[↑ Back to Table of Contents](#)

### **Zone Pay:**

#### **All Districts**

0-30 mi. free zone

>30-60 mi. base pay + \$3.50/hr.

>60 mi. base pay + \$5.50/hr.

## CONSTRUCTION EQUIPMENT OPERATORS GROUP 4

	<b>Wage</b>	<b>Benefit</b>
District 1	\$30.45	\$12.70
District 2	\$30.45	\$12.70
District 3	\$30.45	\$12.70
District 4	\$30.45	\$12.70

**This group includes but is not limited to:**

Asphalt\Hot Plant Operator; Cranes, 25 tons up to and incl. 44 tons; Crusher Operator; Finish Motor Patrol; Finish Scraper.

[↑ Back to Table of Contents](#)

**Zone Pay:**

**All Districts**

0-30 mi. free zone

>30-60 mi. base pay + \$3.50/hr.

>60 mi. base pay + \$5.50/hr.

## CONSTRUCTION EQUIPMENT OPERATORS GROUP 5

	<b>Wage</b>	<b>Benefit</b>
District 1	\$31.45	\$12.70
District 2	\$31.45	\$12.70
District 3	\$31.45	\$12.70
District 4	\$31.45	\$12.70

**This group includes but is not limited to:**

Cranes, 45 tons up to and incl. 74 tons.

[↑ Back to Table of Contents](#)

**Zone Pay:**

**All Districts**

0-30 mi. free zone

>30-60 mi. base pay + \$3.50/hr.

>60 mi. base pay + \$5.50/hr.

## CONSTRUCTION EQUIPMENT OPERATORS GROUP 6

	<b>Wage</b>	<b>Benefit</b>
District 1	\$32.45	\$12.70
District 2	\$32.45	\$12.70
District 3	\$32.45	\$12.70
District 4	\$32.45	\$12.70

**This group includes but is not limited to:**

Cranes, 75 tons up to and incl. 149 tons; Cranes, Whirley (All).

[↑ Back to Table of Contents](#)

**Zone Pay:**

**All Districts**

0-30 mi. free zone

>30-60 mi. base pay + \$3.50/hr.

>60 mi. base pay + \$5.50/hr.

## CONSTRUCTION EQUIPMENT OPERATORS GROUP 7

	<b>Wage</b>	<b>Benefit</b>
District 1	\$33.45	\$12.70
District 2	\$33.45	\$12.70
District 3	\$33.45	\$12.70
District 4	\$33.45	\$12.70

**This group includes but is not limited to:**

Cranes, 150 tons up to and incl. 250 tons; Cranes, over 250 tons—add \$1.00 for every 100 tons over 250 tons; Crane, Tower (All); Crane Stiff-Leg or Derrick; Helicopter Hoist.

**Zone Pay:**

**All Districts**

0-30 mi. free zone  
>30-60 mi. base pay + \$3.50/hr.  
>60 mi. base pay + \$5.50/hr.

[↑ Back to Table of Contents](#)

## CONSTRUCTION LABORERS GROUP 1/FLAG PERSON FOR TRAFFIC CONTROL

	<b>Wage</b>	<b>Benefit</b>
District 1	\$22.10	\$11.77
District 2	\$22.10	\$11.77
District 3	\$22.10	\$11.77
District 4	\$22.10	\$11.77

**Zone Pay:**

**All Districts**

0-15 mi. free zone  
>15-30 mi. base pay + \$0.65/hr.  
>30-50 mi. base pay + \$0.85/hr.  
>50 mi. base pay + \$1.25/hr.

[↑ Back to Table of Contents](#)

## CONSTRUCTION LABORERS GROUP 2

	<b>Wage</b>	<b>Benefit</b>
District 1	\$21.64	\$ 7.87
District 2	\$19.54	\$ 9.29
District 3	\$21.35	\$ 8.31
District 4	\$19.01	\$11.77

**Zone Pay:**

**All Districts**

0-15 mi. free zone  
>15-30 mi. base pay + \$0.65/hr.  
>30-50 mi. base pay + \$0.85/hr.  
>50 mi. base pay + \$1.25/hr.

**This group includes but is not limited to:**

General Labor; Asbestos Removal; Burning Bar; Bucket Man; Carpenter Tender; Caisson Worker; Cement Mason Tender; Cement Handler (dry); Chuck Tender; Choker Setter; Concrete Worker; Curb Machine-lay Down; Crusher and Batch Worker; Heater Tender; Fence Erector; Landscape Laborer; Landscaper; Lawn Sprinkler Installer; Pipe Wrapper; Pot Tender; Powderman Tender; Rail and Truck Loaders and Unloaders; Riprapper; Sign Erection; Guardrail and Jersey Rail; Spike Driver; Stake Jumper; Signalman; Tail Hoseman; Tool Checker and Houseman and Traffic Control Worker.

[↑ Back to Table of Contents](#)

### CONSTRUCTION LABORERS GROUP 3

	<b>Wage</b>	<b>Benefit</b>
District 1	\$23.10	\$11.77
District 2	\$23.10	\$11.77
District 3	\$23.10	\$11.77
District 4	\$23.10	\$11.77

**This group includes but is not limited to:**

Concrete Vibrator; Dumpman (Grademan); Equipment Handler; Geotextile and Liners; High-Pressure Nozzleman; Jackhammer (Pavement Breaker) Non-Riding Rollers; Pipelayer; Posthole Digger (Power); Power Driven Wheelbarrow; Rigger; Sandblaster; Sod Cutter-Power and Tamper.

[↑ Back to Table of Contents](#)

**Zone Pay:**

**All Districts**

0-15 mi. free zone  
>15-30 mi. base pay + \$0.65/hr.  
>30-50 mi. base pay + \$0.85/hr.  
>50 mi. base pay + \$1.25/hr.

### CONSTRUCTION LABORERS GROUP 4

	<b>Wage</b>	<b>Benefit</b>
District 1	\$22.07	\$11.77
District 2	\$23.07	\$11.77
District 3	\$21.31	\$11.77
District 4	\$22.13	\$11.77

**This group includes but is not limited to:**

Hod Carrier\*\*\*; Water Well Laborer; Blaster; Wagon Driller; Asphalt Raker; Cutting Torch; Grade Setter; High-Scaler; Power Saws (Faller & Concrete) Powderman; Rock & Core Drill; Track or Truck Mounted Wagon Drill and Welder incl. Air Arc.

[↑ Back to Table of Contents](#)

**Zone Pay:**

**All Districts**

0-15 mi. free zone  
>15-30 mi. base pay + \$0.65/hr.  
>30-50 mi. base pay + \$0.85/hr.  
>50 mi. base pay + \$1.25/hr.

\*\*\*Hod Carriers will receive the same amount of travel and/or subsistence pay as bricklayers when requested to travel.

### DRYWALL APPLICATORS

	<b>Wage</b>	<b>Benefit</b>
District 1	\$25.75	\$13.82
District 2	\$25.75	\$14.11
District 3	\$25.75	\$13.82
District 4	\$25.75	\$13.82

**Duties Include:**

Drywall and ceiling tile installation.

[↑ Back to Table of Contents](#)

**Zone Pay:**

**All Districts**

0-30 mi. free zone  
>30-60 mi. base pay + \$4.00/hr.  
>60 mi. base pay + \$6.00/hr.



## ELECTRICIANS: INCLUDING BUILDING AUTOMATION CONTROL

	<b>Wage</b>	<b>Benefit</b>
District 1	\$32.22	\$14.97
District 2	\$32.06	\$15.50
District 3	\$32.65	\$15.33
District 4	\$35.59	\$15.82

### **Duties Include:**

Electrical wiring; equipment and fixtures; street lights; electrical control systems. Installation and/or adjusting of building automation controls also during testing and balancing, commissioning and retro-commissioning.

### **Travel:**

#### **District 1**

No mileage due when traveling in employer's vehicle.

The following travel allowance is applicable when traveling in employee's vehicle:

- 0-15 mi. free zone
- >15-45 mi. \$0.585/mi. in excess of the free zone.
- >45 mi. \$75.00/day

#### **Districts 2 and 3**

No mileage due when traveling in employer's vehicle.

The following travel allowance is applicable when traveling in employee's vehicle:

- 0-08 mi. free zone
- >08-50 mi. federal mileage rate/mi. in excess of the free zone.
- >50 mi. \$60.57/day

#### **District 4**

No mileage due when traveling in employer's vehicle.

The following travel allowance is applicable when traveling in employee's vehicle:

- 0-18 mi. free zone
- >18-60 mi. federal mileage rate/mi.
- >60 mi. \$75.00/day

[↑ Back to Table of Contents](#)

## ELEVATOR CONSTRUCTORS

	<b>Wage</b>	<b>Benefit</b>
District 1	\$55.73	\$40.98
District 2	\$55.73	\$40.98
District 3	\$55.73	\$40.98
District 4	\$55.73	\$40.98

### **Travel:**

#### **All Districts**

- 0-15 mi. free zone
- >15-25 mi. \$49.88/day
- >25-35 mi. \$99.75/day
- >35 mi. \$84.90/day or cost of receipts for hotel and meals, whichever is greater.

[↑ Back to Table of Contents](#)

## FLOOR LAYERS

### No Rate Established

Apply blocks, strips, or sheets of shock-absorbing, sound-deadening, or decorative coverings to floors.

[↑ Back to Table of Contents](#)

## GLAZIERS

	<b>Wage</b>	<b>Benefit</b>
District 1	\$23.28	\$5.66
District 2	\$23.28	\$5.66
District 3	\$23.28	\$5.66
District 4	\$23.58	\$5.66

[↑ Back to Table of Contents](#)

### Travel and Per Diem:

#### All Districts

No travel or per diem established.

## HEATING AND AIR CONDITIONING

	<b>Wage</b>	<b>Benefit</b>
District 1	\$31.84	\$19.89
District 2	\$31.84	\$19.89
District 3	\$31.36	\$17.68
District 4	\$31.84	\$19.89

### Duties Include:

Testing and balancing, commissioning and retro-commissioning of all air-handling equipment and duct work.

[↑ Back to Table of Contents](#)

### Travel:

#### All Districts

0-45 mi. free zone

>45 mi.

- \$0.25/mi. in employer vehicle.
- \$0.65/mi. in employee vehicle.

### Per Diem:

#### All Districts

\$85/day

## INSULATION WORKERS - MECHANICAL (HEAT AND FROST)

	<b>Wage *</b>	<b>Benefit *</b>
District 1	\$37.37	\$19.87
District 2	\$37.37	\$19.87
District 3	\$37.37	\$19.87
District 4	\$37.37	\$19.87

### Duties Include:

Insulate pipes, ductwork or other mechanical systems.

### Travel: \*

#### All Districts

0-30 mi. free zone

>30-40 mi. \$25.00/day

>40-50 mi. \$35.00/day

>50-60 mi. \$50.00/day

>60 mi. \$60.00/day plus

- \$0.56/mi. if transportation is not provided.
- \$0.20/mi. if in company vehicle.

>60 mi. \$100.00/day on jobs requiring an overnight stay plus

- \$0.56/mi. if transportation is not provided.
- \$0.20/mi. if in company vehicle.

[↑ Back to Table of Contents](#)

## IRONWORKERS - STRUCTURAL STEEL AND REBAR PLACERS

	<b>Wage</b>	<b>Benefit</b>
District 1	\$29.15	\$27.05
District 2	\$29.01	\$24.71
District 3	\$29.01	\$23.96
District 4	\$29.01	\$23.96

### Duties Include:

Structural steel erection; assemble prefabricated metal buildings; cut, bend, tie, and place rebar; energy producing windmill type towers; metal bleacher seating; handrail fabrication and ornamental steel.

### Travel:

#### District 1

0-45 mi. free zone

>45-60 mi. \$45.00/day

>60-100 mi. \$70.00/day

>100 mi. \$90.00/day

### Special Provision:

When the employer provides transportation, travel will not be paid. However, when an employee is required to travel over 70 miles one way, the employee may elect to receive the travel pay in lieu of the transportation.

### Districts 2, 3 & 4

0-45 mi. free zone

>45-85 mi. \$70.00/day

>85 mi. \$100.00/day

[↑ Back to Table of Contents](#)

## MILLWRIGHTS

	<b>Wage</b>	<b>Benefit</b>
District 1	\$39.68	\$14.27
District 2	\$39.68	\$14.27
District 3	\$39.68	\$14.27
District 4	\$39.68	\$14.27

### Zone Pay:

#### All Districts

0-30 mi. free zone

>30-60 mi. base pay + \$4.00/hr.

>60 mi. base pay + \$6.00/hr.

[↑ Back to Table of Contents](#)

\* Amended 3/11/2022

## PAINTERS: INCLUDING PAPERHANGERS

	<b>Wage</b>	<b>Benefit</b>
District 1	\$23.54	\$0.00
District 2	\$23.54	\$0.00
District 3	\$23.17	\$0.00
District 4	\$23.17	\$0.00

[↑ Back to Table of Contents](#)

### **Travel and Per Diem:**

#### **All Districts**

No travel or per diem established.

## PILE BUCKS

	<b>Wage</b>	<b>Benefit</b>
District 1	\$32.75	\$13.82
District 2	\$32.75	\$14.11
District 3	\$32.75	\$13.82
District 4	\$32.75	\$13.82

### **Duties Include:**

Set up crane; set up hammer; weld tips on piles; set leads; insure piles are driven straight with the use of level or plum bob. Give direction to crane operator as to speed and direction of swing. Cut piles to grade.

[↑ Back to Table of Contents](#)

### **Zone Pay:**

#### **All Districts**

0-30 mi. free zone

>30-60 mi. base pay + \$4.00/hr.

>60 mi. base pay + \$6.00/hr.

## PLASTERERS

### **No Rate Established**

### **Duties Include:**

All materials beyond the substrate, such as a moisture barrier, any type of drainage installation between the moisture barrier and insulation or EPS board, the attachment of the EPS board, installation of fiberglass mesh embedded in the base coat, any water-resistant coat that is applied on top of the insulation to serve as a weather barrier, and the application of the finish coat.

[↑ Back to Table of Contents](#)

### **Travel and Per Diem:**

#### **All Districts**

No travel or per diem established.

## PLUMBERS, PIPEFITTERS, AND STEAMFITTERS

	<b>Wage</b>	<b>Benefit</b>
District 1	\$34.38	\$16.01
District 2	\$36.35	\$16.00
District 3	\$36.35	\$16.00
District 4	\$34.21	\$19.86

### **Duties Include:**

Assemble, install, alter, and repair pipe-lines or pipe systems that carry water, steam, air, other liquids or gases. Testing of piping systems, commissioning and retro-commissioning. Workers in this occupation may also install heating and cooling equipment and mechanical control systems.

### **Travel:**

#### **District 1**

0-30 mi. free zone  
>30-50 mi. \$30.00/day  
>50-75 mi. \$45.00/day  
>75 mi. \$85.00/day

#### **Special Provision**

If transportation is not provided, mileage at \$0.35/mi. for one trip out and one trip back is added to the amounts above. However, if the employee is traveling more than 75 miles/day, only subsistence at the rate of \$85.00/day is required.

#### **Districts 2 & 3**

0-45 mi. free zone  
>45 mi.

- \$0.00/mi. in employer vehicle.
- \$0.65/mi. in employee vehicle.

#### **Special Provision:**

At the contractors' option, mileage for one trip out and one trip back per week may be paid plus subsistence at the rate of \$135.00/day.

In the alternative, employers may pay the employee the hourly rate of travel time in **employer's** vehicle as an alternative to mileage. When using an **employee's** vehicle, employee may be paid at 1 ½ times the hourly rate of pay as an alternative to mileage. If the hourly rate is chosen over mileage pay, hours shall be paid in half (1/2) hour increments.

#### **District 4**

0-70 free zone  
>70 mi.

- On jobs when employees do not work consecutive days: \$0.55/mi. if employer doesn't provide transportation. Not to exceed two trips.
- On jobs when employees work any number of consecutive days: \$105.00/day.

[↑ Back to Table of Contents](#)

## ROOFERS

	<b>Wage</b>	<b>Benefit</b>
District 1	\$24.14	\$8.12
District 2	\$21.69	\$9.66
District 3	\$22.85	\$5.42
District 4	\$23.44	\$5.68

### Duties Include:

Metal roofing, covers roofs, walls and foundations with water proofing, insulation and vapor barriers in addition to metal flashings. Roofing includes shingles, low slope membranes, metal roofs, insulation, spray foam, coatings and vapor barriers. Wall coverings include metal panels, insulated metal panels and other waterproofing or rain screen systems. Foundation systems include waterproofing and insulation. Excludes prefabricated metal buildings

### Travel:

#### District 1

0-50 mi. free zone  
>50 mi. \$0.35/mi.

#### District 2 and 3

0-35 mi. free zone  
>35 mi. \$0.30/mi only when employer doesn't provide transportation.

#### District 4

0-50 mi. free zone  
>50 mi. \$0.35/mi only when employer doesn't provide transportation.

### Per Diem:

#### District 1

\$69.00/day

#### District 2 and 3

Employer pays for room + \$26.50/day.

#### District 4

\$63.00/day.

[↑ Back to Table of Contents](#)

## SHEET METAL WORKERS

	<b>Wage</b>	<b>Benefit</b>
District 1	\$31.84	\$19.89
District 2	\$31.84	\$19.89
District 3	\$31.84	\$19.89
District 4	\$31.84	\$19.89

### Duties Include:

Testing and balancing, commissioning and retro-commissioning of all air-handling equipment and duct work. Manufacture, fabrication, assembling, installation, dismantling, and alteration of all HVAC systems, air conveyer systems, and exhaust systems. All lagging over insulation and all duct lining.

### All Districts

0-45 mi. free zone  
>45 mi.

- \$0.25/mi. in employer vehicle.
- \$0.65/mi. in employee vehicle.

### Per Diem:

#### All Districts

\$90/day

[↑ Back to Table of Contents](#)

## SOLAR PHOTOVOLTAIC INSTALLERS

	<b>Wage</b>	<b>Benefit</b>
District 1	\$31.79	\$15.86
District 2	\$32.65	\$16.39
District 3	\$32.65	\$15.33
District 4	\$35.59	\$15.82

### **Travel:**

#### **Districts 1, 2 and 3**

No mileage due when traveling in employer's vehicle.

The following travel allowance is applicable when traveling in employee's vehicle:

0-08 mi. free zone

>08-50 mi. federal mileage rate/mi. in excess of the free zone.

>50 mi. \$60.57/day

#### **District 4**

No mileage due when traveling in employer's vehicle.

The following travel allowance is applicable when traveling in employee's vehicle:

0-18 mi. free zone

>18-60 mi. federal mileage rate/mi.

>60 mi. \$75.00/day

[↑ Back to Table of Contents](#)

## SPRINKLER FITTERS

	<b>Wage</b>	<b>Benefit</b>
District 1	\$37.20	\$24.29
District 2	\$35.66	\$24.29
District 3	\$35.23	\$19.20
District 4	\$35.66	\$24.29

### Duties Include:

Duties Include but not limited to any and all fire protection systems: Installation, dismantling, inspection, testing, maintenance, repairs, adjustments, and corrections of all fire protection and fire control systems, including both overhead and underground water mains, all piping, fire hydrants, standpipes, air lines, tanks, and pumps used in connection with sprinkler and alarm systems.

### Travel

#### All Districts

The following travel allowance is applicable when traveling in employee's vehicle.

- 0-60 mi. free zone
- >60-80 mi. \$19.00/day
- >80-100 mi. \$29.00/day
- >100 mi. \$105.00/day + the IRS rate per mile and \$8.92 for every 15 miles traveled for one trip out and one trip back

No travel allowance required when in employer's vehicle.

### Per Diem

No per diem is applicable when traveling in employee's vehicle

The following per diem is applicable when traveling in employer's vehicle.

- 0-100 mi. free zone
- >100 mi. \$105.00/day + the IRS rate per mile and \$8.92 for every 15 miles traveled for one trip out and one trip back.

[↑ Back to Table of Contents](#)

## TAPERS

No Rate Established

### Travel and Per Diem:

#### All Districts

No travel or per diem established.

[↑ Back to Table of Contents](#)

## TELECOMMUNICATIONS EQUIPMENT INSTALLERS

	<b>Wage</b>	<b>Benefit</b>
District 1	\$24.56	\$ 9.56
District 2	\$24.73	\$10.91
District 3	\$24.73	\$ 8.52
District 4	\$24.73	\$10.63

### Duties Include:

Install voice; sound; vision and data systems. This occupation includes burglar alarms, fire alarms, fiber optic systems, and video systems for security or entertainment

### Travel:

#### All Districts

The federal mileage rate/mi. in effect when travel occurs if using own vehicle.

### Per Diem:

#### All Districts

Employer pays for meals and lodging up to \$75.00/day. When jobsite is located in Big Sky, West Yellowstone, and Gardiner, lodging and meals will be provided by the employer for all actual and reasonable expenses incurred.

[↑ Back to Table of Contents](#)



## TERRAZZO WORKERS AND FINISHERS

**No Rate Established**

**Duties Include:**

Finish work on hard tile, marble, and wood tile to floors, ceilings, and roof decks

[↑ Back to Table of Contents](#)

## TILE AND STONE SETTERS

**No Rate Established**

**Duties Include:**

Apply hard tile, stone, and comparable materials to walls, floors, ceilings, countertops, and roof decks.

[↑ Back to Table of Contents](#)

## TRUCK DRIVERS

Pilot Car Driver **No Rate Established**

	<b>Wage</b>	<b>Benefit</b>
District 1	\$26.43	\$9.98
District 2	\$26.43	\$9.98
District 3	\$28.88	\$7.68
District 4	\$27.71	\$6.55

**Truck drivers include but are not limited to:**

Combination Truck & Concrete Mixer; Distributor Driver; Dry Batch Trucks; Dump Trucks & Similar Equipment; Flat Trucks; Lowboys, Four-Wheel Trailers, Float Semitrailer; Powder Truck Driver (Bulk Unloader Type); Servicemen; Service Truck Drivers, Fuel Truck Drivers, Tiremen; Trucks with Power Equipment; Truck Mechanic; Water Tank Drivers, Petroleum Product Drivers.

[↑ Back to Table of Contents](#)

**Zone Pay:  
All Districts**

No zone pay established.



**GENERAL CONDITIONS  
OF THE CONTRACT FOR CONSTRUCTION**

**State of Montana Version**  
(Form Revision Date: 5/2021)

# FRONT PAGE HIGHLIGHTS

Note: This list of items is not an exhaustive or all-inclusive list of the contractor's responsibilities for the Project but is provided solely for convenience and reference.

ITEM	REFERENCE	GENERAL CONDITIONS
Prevailing Wage Rates	<a href="#">Article 3.4.4</a>	The Commissioner of The Montana Department of Labor and Industry (DOLI) has established the standard prevailing rate of wages in accordance with 18-2-401 and 18-2-402, MCA.
Warranty	<a href="#">Article 3.5.2</a>	The warranty period shall be defined as commencing with Substantial Completion (or with each Substantial Completion if there is more than one) of the Project, or any portion thereof, and continuing for one (1) calendar year from the date of Final Acceptance of the entire project.
Schedule	<a href="#">Article 3.10.1</a>	The Contractor's schedule shall be in the "Critical Path Method" and shall be in a form that is acceptable to the Owner and meet all the conditions of 3.10.
Time Limit on Claims	<a href="#">Article 4.3.1.1</a>	Claims by either party must be initiated within 21 calendar days after occurrence of the event giving rise to such claim.
Weather Delays	<a href="#">Article 4.3.5.2</a>	If adverse weather conditions are the basis for a Claim for additional time, such Claim shall be documented by data substantiating that weather conditions were abnormal for the period of time, could not have been reasonably anticipated, and had an adverse effect on the current critical- path scheduled construction activities.
Waiver of Consequential Damages	<a href="#">Article 4.3.6</a>	The Contractor and Owner waive Claims against each other for consequential damages arising out of or relating to this Contract.
Mediation & Arbitration	Article <a href="#">4.5</a> & <a href="#">4.6</a>	The parties shall endeavor to resolve their Claims by mediation unless the parties mutually agree otherwise. Claims not resolved by mediation shall be decided by arbitration.
Changes	<a href="#">Article 7</a>	Changes in the Work may be accomplished after execution of the Contract, and without invalidating the Contract, by Change Order, Construction Change Directive, or order for a minor change in the Work subject to the limitations stated in this Article 7 and elsewhere in the Contract Documents.
Change Order Allowable Costs	<a href="#">Article 7.2.2.1</a>	As described with a 5% allowance for overhead and a 10% allowance for profit.
Time	<a href="#">Article 8</a>	Time is of the essence in performance, coordination, and completion of the Work contemplated herein.
Liquidated Damages	<a href="#">Article 8.1.6</a>	The Contractor and his surety shall be liable for and shall pay to the Owner the sums stipulated as liquidated damages for each calendar day of delay until the Work is substantially complete.
Contract Duration/Milestones/Phases	<a href="#">Article 8.1.9</a>	All Work shall reach Substantial Completion by the date(s) listed or within the consecutive calendar days indication after the start date on the written Notice To Proceed.
Applications for Payment	<a href="#">Article 9.3.2</a>	The Owner has thirty-five (35) calendar days after receipt for approval of the Contractor's Pay Request without being subject to the accrual of interest.
Retainage	<a href="#">Article 9.3.7</a>	Until the Work is complete, the Owner will pay 95% of the amount due the Contractor on account of progress payments. If the Work and its progress are not in accordance with all or any part, piece, or portion of the Contract Documents, the Owner may, at its sole discretion and without claim by the Contractor, increase the amount held as retainage to whatever level deemed necessary to effectuate performance and progress of the Work.
Safety & Protection	<a href="#">Article 10</a>	The Contractor shall be solely responsible for initiating, maintaining and supervising all safety, safety precautions, and safety programs in connection with the performance of the Contract.
Indemnification and Insurance Requirements	<a href="#">Article 11</a>	The Contractor shall indemnify the Owner against the Contractor's negligence. The Contractor shall least carry Workers' Comp, General Liability, Automobile/Equipment, and Property (all-risk) Insurance Coverages as identified. State of Montana shall be listed as an additional insured with copy of ENDORSEMENT provided along with certificates of insurance. No waivers of subrogation shall be accepted.
Performance & Payment Bonds	<a href="#">Article 11.7</a>	The Contract shall furnish a Performance Bond in the amount of 100% of the contract price as security for the faithful performance of his contract. The Contractor shall also furnish a Labor and Material Payment Bond in the amount of 100% of the contract price as security for the payment of all persons performing labor and furnishing materials in connection therewith.
Payroll & Basic Records	<a href="#">Article 13.8</a>	Payrolls and basic records pertaining to the project shall be kept on a generally recognized accounting basis and shall be available to the Owner, Legislative Auditor, the Legislative Fiscal Analyst or his authorized representative at mutually convenient times. Accounting records shall be kept by the Contractor for a period of three years after the date of the Owner's Final Acceptance of the Project.

---

---

# GENERAL CONDITIONS OF THE CONTRACT FOR CONSTRUCTION

(Form Revision Date: MSU 5/2021)

## ARTICLE 1 – GENERAL PROVISIONS

### 1.1. BASIC DEFINITIONS

1.1.1. **CONTRACT DOCUMENTS.** The Contract Documents consist of the Contract between Owner and Contractor (hereinafter the “Contract”), Conditions of the Contract (General, Supplementary and other Conditions), Drawings, Specifications, Addenda issued prior to execution of the Contract, other documents listed in the Contract and Modifications issued after execution of the Contract. A Modification is: (1) a written amendment to the Contract signed by both parties; (2) a Change Order; (3) a Construction Change Directive; or, (4) a written order for a minor change in the Work issued by the Architect/Engineer. The Contract Documents shall include the bidding documents and any alterations made thereto by addenda. In the event of a conflict, discrepancy, contradiction, or inconsistency within the Contract Documents and for the resolution of same, the following order of hierarchy and control shall apply and prevail:

1) Contract; 2) Addenda; 3) Supplementary General Conditions; 4) General Conditions; 5) Specifications; 6) Drawings; 7) Instructions to Bidders; 8) Invitation To Bid; 9) Sample Forms.

1.1.1.1. If a conflict, discrepancy, contradiction, or inconsistency occurs within or between the Specifications and the Drawings, resolution shall be controlled by the following:

1.1.1.1.1. As between figures, dimensions, or numbers given on drawings and any scaled measurements, the figures, dimensions, or numbers shall govern;

1.1.1.1.2. As between large scale drawings and small scale drawings, the larger scale drawings shall govern;

1.1.1.1.3. As between the technical specifications and drawings; the technical specifications shall govern.

1.1.1.1.4. Shop Drawings and Submittals: Shop drawings and other submittals from the Contractor, subcontractors, or suppliers do not constitute a part of the Contract Documents.

1.1.1.2. The Contractor acknowledges, understands and agrees that the Contract Documents cannot be changed except as provided herein by the terms of the Contract. No act(s), action(s), omission(s), or course of dealing(s) by the Owner or Architect/Engineer with the Contractor shall alter the requirements of the Contract Documents and that alteration can be accomplished only through a written Modification process defined herein.

1.1.2. **THE DRAWINGS.** The Drawings are the graphic and pictorial portions of the Contract Documents showing the design, intent, location, and dimensions of the Work, generally including plans, elevations, sections, details, schedules and diagrams.

1.1.3. **THE SPECIFICATIONS.** The Specifications are that portion of the Contract Documents consisting of the written requirements for materials, equipment, systems, standards and workmanship for the Work, and performance of related services.

1.1.4. **THE CONTRACT.** The entire Contract for Construction is formed by the Contract Documents. The Contract represents the entire, complete, and integrated agreement between the Owner and Contractor.

hereto and supersedes prior negotiations, representations or agreements, either written or oral. The Contract may be amended or modified only by a Modification. The Contract Documents shall not be construed to create a contractual relationship of any kind between: (1) the Architect/Engineer and Contractor; (2) the Owner and any Subcontractor, Sub-subcontractor, or Supplier; (3) the Owner and Architect/Engineer; or, (4) between any persons or entities other than the Owner and Contractor. However, the Architect/Engineer shall at all times be permitted and entitled to performance and enforcement of its obligations under the Contract intended to facilitate performance of the Architect/Engineer's duties.

- 1.1.5. THE WORK. The term "Work" means the construction and services required by the Contract Documents, whether completed or partially completed, and includes all other labor, materials, equipment and services provided or to be provided by the Contractor to completely fulfill the Contract and the Contractor's obligations. The Work may constitute the whole or a part of the Project.
- 1.1.6. THE PROJECT. The Project is the total construction of which the Work performed under the Contract Documents may be the whole or a part and which may include construction by the Owner or by separate contractors.
- 1.1.7. TIME. Time is of the essence in performance, coordination, and completion of the Work contemplated herein. The Owner may suffer damages if the Work is not completed as specified herein. When any duration or time period is referred to in the Contract Documents by days, the first day of a duration or time period shall be determined as the day following the current day of any event or notice starting a specified duration. All durations in the Contract Documents are calendar days unless specifically stated otherwise.

## **1.2. CORRELATION, INTER-RELATIONSHIP, AND INTENT OF THE CONTRACT DOCUMENTS**

- 1.2.1. The intent of the Contract Documents is to include all items and all effort necessary for the proper execution and completion of the Work by the Contractor. The Contract Documents are complementary and inter-related, and what is required by one shall be as binding as if required by all. Performance by the Contractor shall be required to the extent consistent with the Contract Documents and reasonably inferable from them as being necessary to produce the indicated results.
- 1.2.2. Organization of the Specifications into divisions, sections and articles, and arrangement of Drawings shall not control the Contractor in dividing the Work among Subcontractors or in establishing the extent of Work to be performed by any trade. It is the Contractor's responsibility to control the Work under the Contract.
- 1.2.3. Unless otherwise stated in the Contract Documents, words which have well-known technical or construction industry meanings are used in the Contract Documents in accordance with such recognized meanings.

## **1.3. CAPITALIZATION**

- 1.3.1. Terms capitalized in these General Conditions include those which are: (1) specifically defined; and, (2) the titles of numbered articles and identified references to Paragraphs, Subparagraphs and Clauses in the document.

## **1.4. INTERPRETATION**

- 1.4.1. In the interest of brevity the Contract Documents frequently omit modifying words such as "all" and "any" and articles such as "the" and "an," but the fact that a modifier or an article is absent from one statement and appears in another is not intended to affect the interpretation of either statement.

## **1.5. EXECUTION OF THE CONTRACT AND CONTRACT DOCUMENTS**

- 1.5.1. The Contract shall be signed by the Owner and Contractor. Execution of the Contract by the Contractor constitutes the complete and irrevocable binding of the Contractor and his Surety to the Owner for complete performance of the Work and fulfillment of all obligations. By execution of the Contract, the Contractor acknowledges that it has reviewed and familiarized itself with all aspects of the Contract Documents and agrees to be bound by the terms and conditions contained therein.

- 1.5.2. Execution of the Contract by the Contractor is a representation that the Contractor has visited the site, become generally familiar with local conditions under which the Work is to be performed, and correlated personal observations with requirements of the Contract Documents.
- 1.5.3. The Contractor acknowledges that it has taken all reasonable actions necessary to ascertain the nature and location of the work, and that it has investigated and satisfied itself as to the general and local conditions which can affect the work or its cost, including but not limited to: (1) conditions bearing upon transportation, disposal, handling, and storage of materials; (2) the availability of labor, water, gas, electric power, phone service, and roads; (3) uncertainties of weather, river stages, tides, or similar physical conditions at the site; (4) the conformation, topography, and conditions of the ground; and, (5) the character of equipment and facilities needed for performance of the Work. The Contractor also acknowledges that it has satisfied itself as to the character, quality, and quantity of surface and subsurface materials or obstacles to be encountered insofar as this information is reasonably ascertainable from an inspection of the site, including all exploratory geotechnical work done by the Owner, as well as from the drawings and specifications made a part of this contract. Any failure of the Contractor to take the action described and acknowledged in this paragraph will not relieve the Contractor from responsibility for properly ascertaining and estimating the difficulty and cost of successfully performing the Work or for proceeding to successfully perform the Work without additional expense to the Owner.
- 1.5.4. The Owner assumes no responsibility for any conclusions or interpretations made by the Contractor based on the information made available by the Owner, nor does the Owner assume responsibility for any understanding reached or representation made by any of its officers, agents, or employees concerning conditions which can affect the Work unless that understanding or representation is expressly stated in the Contract Documents.
  - 1.5.4.1. Performance of any portion of the Work beyond that required for complying with the specifications and all other requirements of the Contract, shall be deemed to be for the convenience of the Contractor and shall be at the Contractor's sole expense.
  - 1.5.4.2. There shall be no increase in the contract price or time allowed for performance which is for the convenience of the Contractor.

## **1.6. OWNERSHIP AND USE OF DRAWINGS, SPECIFICATIONS, AND OTHER INSTRUMENTS OF SERVICE**

- 1.6.1. The Drawings, Specifications and other documents, including those in electronic form, prepared by the Architect/Engineer and the Architect/Engineer's consultants are Instruments of Service through which the Work to be executed by the Contractor is described. The Contractor may retain one record set. Neither the Contractor nor any Subcontractor, Sub-subcontractor or material or equipment supplier shall own or claim a copyright in the Drawings, Specifications and other documents prepared by the Architect/Engineer or the Architect/Engineer's consultants. Unless otherwise indicated, the Architect/Engineer and the Architect/Engineer's consultants shall be deemed the authors of them and will retain all common law, statutory and other reserved rights, in addition to the copyrights except as defined in the Owner's Contract with the Architect/Engineer. All copies of Instruments of Service, except the Contractor's record set, shall be returned or suitably accounted for to the Architect/Engineer upon completion of the Work. The Drawings, Specifications and other documents prepared by the Architect/Engineer and the Architect/Engineer's consultants, and copies thereof furnished to the Contractor, are for use solely with respect to this Project. They are not to be used by the Contractor or any Subcontractor, Sub-subcontractor or material or equipment supplier on other projects or for additions to this Project outside the scope of the Work without the specific written consent of the Owner, Architect/Engineer, and the Architect/Engineer's consultants. The Contractor, Subcontractors, Sub-subcontractors and material or equipment suppliers are authorized to use and reproduce applicable portions of the Drawings, Specifications and other documents prepared by the Architect/Engineer and the Architect/Engineer's consultants appropriate to and for use in the execution of their Work under the Contract Documents. All copies made under this authorization shall bear the statutory copyright notice, if any, shown on the Drawings Specifications and other documents prepared by the Architect/Engineer and the Architect/Engineer's consultants. Submittal or distribution to meet official regulatory requirements or for other purposes in connection with this Project is not to be construed as publication in derogation of the Architect/Engineer's or Architect/Engineer's consultants' copyrights or other reserved rights.

- 1.6.2. Owner's Disclaimer of Warranty: The Owner has requested the Architect/Engineer prepare the Contract Documents for the Project which are adequate for bidding and constructing the Project. However, the Owner makes no representation, guarantee, or warranty of any nature whatsoever to the Contractor concerning such documents. The Contractor hereby acknowledges and represents that it has not, does not, and will not rely upon any such representation, guarantee, or warranty concerning the Contract Documents as no such representation, guarantee, or warranty have been or are hereby made.

## **ARTICLE 2 – THE OWNER**

### **2.1. THE STATE OF MONTANA**

- 2.1.1. The Owner is the State of Montana and is the sole entity to be identified as Owner in the Contract and as referred to throughout the Contract Documents as if singular in number.
- 2.1.2. Except as otherwise provided in Subparagraph 4.2.1, the Architect/Engineer does not have authority to bind the Owner. The observations and participations of the Owner or its authorized representative do not alleviate any responsibility on the part of the Contractor. The Owner reserves the right to observe the work and make comment. Any action or lack of action by the Owner shall not be construed as approval of the Contractor's performance.
- 2.1.3. The Owner reserves the right to require the Contractor, all sub-contractors and material suppliers to provide lien releases at any time. The Owner reserves the right to withhold progress payments until such lien releases are received for all work for which prior progress payments have been made. Upon the Owner's demand for lien releases (either verbally or written), the Contractor, all sub-contractors and material suppliers shall provide such releases with every subsequent application for payment through Final Acceptance of the Project.
- 2.1.4. Except for permits and fees, including those required under Subparagraph 3.7.1, which are the responsibility of the Contractor under the Contract Documents, the Owner shall secure and pay for necessary approvals, easements, assessments and charges required for construction, use or occupancy of permanent structures or for permanent changes in existing facilities.
- 2.1.5. Information or services required of the Owner by the Contract Documents shall be furnished by the Owner with reasonable promptness. Any other information or services relevant to the Contractor's performance of the Work under the Owner's control shall be furnished by the Owner after receipt from the Contractor of a written request for such information or services.
- 2.1.6. Unless otherwise provided in the Contract Documents, the Contractor will be furnished, free of charge, such copies of Drawings and Specifications as are reasonably necessary for execution of the Work.

### **2.2. OWNER'S RIGHT TO STOP WORK**

- 2.2.1. If the Contractor fails to correct Work which is not in accordance with the requirements of the Contract Documents as required by Paragraph 12.2 or persistently fails to carry out Work in accordance with the Contract Documents, the Owner may issue a written order to the Contractor to stop the Work, or any portion thereof, until the cause for such order has been eliminated. However, the right of the Owner to stop the Work shall not give rise to a duty on the part of the Owner to exercise this right for the benefit of the Contractor or any other person or entity, except to the extent required by Subparagraph 6.1.3. The issuance of a stop work order by the Owner shall not give rise to a claim by the Contractor or any subcontractor for additional cost, time, or other adjustment.

### **2.3. OWNER'S RIGHT TO CARRY OUT THE WORK**

- 2.3.1. If the Contractor defaults or neglects to carry out the Work in accordance with the Contract Documents and fails within a seven-day period after receipt of written notice from the Owner to commence and continue correction of such default or neglect with diligence and promptness, the Owner may after such seven-day period give the Contractor a second written notice to correct such deficiencies within a three-day period. If the Contractor within such three-day period after receipt of such second notice fails to commence and continue to correct any deficiencies, the Owner may, without prejudice to other remedies the Owner may have, correct such deficiencies. In such case an appropriate Change Order shall be

issued deducting from payments then or thereafter due the Contractor the reasonable cost of correcting such deficiencies, including Owner's expenses and increased costs, and compensation for the Architect/Engineer's additional services made necessary by such default, neglect, or failure. If payments then or thereafter due the Contractor are not sufficient to cover such amounts, the Contractor shall pay the difference to the Owner.

## **2.4. OWNER'S RIGHT TO PERSONNEL**

- 2.4.1. The Owner reserves the right to have the Contractor and/or subcontractors remove person(s) and/or personnel from any and all work on the project with cause but without cost to the Owner. Such requests from the Owner may be made verbally or in writing and may be done directly with the Contractor or indirectly through the Architect/Engineer. Cause may be, but not limited to, any of the following: incompetence, poor workmanship, poor scheduling abilities, poor coordination, disruption to the facility or others, poor management, causes delay or delays, disruption of the Project, will not strictly adhere to facility procedures and Project requirements either knowingly or unknowingly, insubordination, drug/alcohol use, possession of contraband, belligerent acts or actions, etc. The Contractor shall provide replacement person(s) and/or personnel acceptable to the Owner at no cost to the Owner.
- 2.4.2. Any issue or circumstance relating to or resulting out of this clause shall not be construed or interpreted to be interference with or impacting upon the Contractor's responsibilities and liabilities under the Contract Documents.
- 2.4.3. Person(s) and/or personnel who do not perform in accordance with the Contract Documents, shall be deemed to have provided the Owner with cause to have such persons removed from any and all involvement in the Work.
- 2.4.4. The Contractor agrees to indemnify and hold harmless the Owner from any and all causes of action, demands, claims, damages, awards, attorneys' fees, and other costs brought against the Owner and/or Architect/Engineer by any and all person(s) or personnel as a result of actions under this clause.

## **ARTICLE 3 – THE CONTRACTOR**

### **3.1. GENERAL**

- 3.1.1. The Contractor is the person or entity identified as such in the Contract and is referred to throughout the Contract Documents as if singular in number. The term "Contractor" means the Contractor or the Contractor's authorized representative.
- 3.1.2. Construction Contractor Registration: The Contractor is required to be registered with the Department of Labor and Industry under 39-9-201 and 39-9-204 MCA prior to the Contract being executed by the Owner. A bidder must demonstrate that it has registered or promises that it will register immediately upon notice of award and prior to the commencement of any work. If the prevailing bidder cannot or does not register in time for the Owner to execute the Contract within fifteen (15) days of the date on the notice of award, the Owner may award, at its sole discretion, to the next lowest responsible bidder who meets this requirement. The Owner will not execute a contract for construction nor issue a Notice to Proceed to a Contractor who is not registered per 39-9-401(a) MCA. It is solely the Contractor's responsibility to ensure that all Subcontractors are registered in accordance with Title 39, Chapter 9, MCA.
- 3.1.3. The Owner's engagement of the Contractor is based upon the Contractor's representations by submission of a bid to the Owner that it:
  - 3.1.3.1. has the requisite skills, judgment, capacity, expertise, and financial ability to perform the Work;
  - 3.1.3.2. is experienced in the type of labor and services the Owner is engaging the Contractor to perform;
  - 3.1.3.3. is authorized, licensed and registered to perform the type of labor and services for which it is being engaged in the State and locality in which the Project is located;



- 3.1.3.4. is qualified, willing and able to perform the labor and services for the Project in the manner and scope defined in the Contract Documents; and,
- 3.1.3.5. has the expertise and ability to provide labor and services that will meet the Owner's objectives, intent and requirements, and will comply with the requirements of all governmental, public, and quasi-public authorities and agencies having or asserting jurisdiction over the Project.
- 3.1.4. The Contractor shall perform the Work in accordance with the Contract Documents.
- 3.1.5. The Contractor shall not be relieved of obligations to perform the Work in accordance with the Contract Documents either by activities or duties of the Architect/Engineer in the Architect/Engineer's administration of the Contract, or by tests, inspections or approvals required or performed by persons other than the Contractor.
- 3.1.6. Quality Control (i.e. ensuring compliance with the Contract Documents) and Quality Assurance (i.e. confirming compliance with the Contract Documents) are the responsibility of the Contractor. Testing, observations, and/or inspections performed or provided by the Owner are solely for the Owner's own purposes and are for the benefit of the Owner. The Owner is not liable or responsible in any form or fashion to the Contractor regarding quality assurance or extent of such assurances. The Contractor shall not, under any circumstances, rely upon the Owner's testing or inspections as a substitute or in lieu of its own Quality Control or Assurance programs.
- 3.1.7. Buy-Safe Montana Provision: The Owner shall review the Buy-Safe Montana Form provided by the Bidder under Articles 16 of the Instructions to Bidders. To promote a safe work environment, the Owner encourages an incidence rate less than the latest average for non-residential building construction for Montana as established by the federal Bureau of Labor Statistics for the prior year; an experience modification rating (EMR) less than 1.0; and a loss ratio of less than 100%. The Contractor with a greater-than-average incidence rate, an EMR greater than 1.0, and a loss ratio of more than 100% shall schedule and obtain a Comprehensive Safety Consultation from the Montana Department of Labor & Industry, Employment Relations Division, Safety Bureau before the Owner grants Substantial Completion of the Work. For assistance in obtaining the Comprehensive Safety Consultation, visit <http://erd.dli.mt.gov/safety-health/onsite-consultation>.

### **3.2. REVIEW OF CONTRACT DOCUMENTS AND FIELD CONDITIONS BY CONTRACTOR**

- 3.2.1. Since the Contract Documents are complementary and inter-related, before starting each portion of the Work, the Contractor shall carefully study and compare the various Drawings and other Contract Documents relative to that portion of the Work, shall take field measurements of any existing conditions related to that portion of the Work and shall observe any conditions affecting the Work. These obligations are for the purpose of facilitating construction by the Contractor and are not for the purpose of discovering errors, omissions, or inconsistencies in the Contract Documents. However, any errors, inconsistencies or omissions discovered by the Contractor shall be reported promptly to the Architect/Engineer as a request for information in such form as the Architect/Engineer may require.
- 3.2.2. Any errors or omissions noted by the Contractor during this review shall be reported promptly to the Architect/Engineer, but it is recognized that the Contractor's review is made in the Contractor's capacity as a contractor and not as a licensed design professional unless otherwise specifically provided in the Contract Documents.
- 3.2.3. If the Contractor believes that additional cost or time is involved because of clarifications or instructions issued by the Architect/Engineer in response to the Contractor's notices or requests for information pursuant to Subparagraphs 3.2.1 and 3.2.2, the Contractor shall make Claims as provided in Subparagraphs 4.3.4 and 4.3.5. If the Contractor fails to perform the obligations of Subparagraphs 3.2.1 and 3.2.2, the Contractor shall pay such costs and damages to the Owner as would have been avoided if the Contractor had performed such obligations. The Contractor shall not be liable to the Owner or Architect/Engineer for damages resulting from errors, inconsistencies, or omissions in the Contract Documents or for differences between field measurements or conditions and the Contract Documents unless the Contractor recognized such error, inconsistency, omission or difference and failed to report it to the Architect/Engineer.

- 3.2.4. Except as otherwise expressly provided in this Contract, the Contractor assumes all risks, liabilities, costs, and consequences of performing any effort or work in accordance with any written or oral order (including but not limited to direction, instruction, interpretation, or determination) of a person not authorized in writing by the Owner to issue such an order.
- 3.2.5. By entering into this Contract, the Contractor acknowledges that it has informed itself fully regarding the requirements of the Drawings and Specifications, the General Conditions, the Supplementary General Conditions, all other documents comprising a part of the Contract Documents and all applicable laws, building codes, ordinances and regulations. Contractor hereby expressly acknowledges, guarantees, and warrants to the Owner that:
- 3.2.5.1. the Contract Documents are sufficient in detail and scope to enable Contractor to construct the finished project;
  - 3.2.5.2. no additional or further work should be required by Owner at the time of Owner's acceptance of the Work; and,
  - 3.2.5.3. when the Contractor's work is finished and the Owner accepts, the Work will be complete and fit for the purpose intended by the Contract Documents. This acknowledgment and guarantee does not imply that the Contractor is assuming responsibilities of the Architect/Engineer.
- 3.2.6. Sufficiency of Contract Documents: Prior to submission of its bid, and in all events prior to and upon signing the Contract, the Contractor certifies, warrants and guarantees that it has received, carefully reviewed, and evaluated all aspects of the Contract Documents and agrees that said Documents are adequate, consistent, coordinated, and sufficient for bidding and constructing the Work requested, intended, conceived, and contemplated therein.
- 3.2.6.1. The Contractor further acknowledges its continuing duty to review and evaluate the Contract Documents during the performance of its services and shall immediately notify the Architect/Engineer of any problems, conflicts, defects, deficiencies, inconsistencies, errors, or omissions it discovers in the Contract Documents and the Work to be constructed; and, any variances it discovers between the Contract Documents and applicable laws, statutes, building codes, rules or regulations.
  - 3.2.6.2. If the Contractor performs any Work which it knows or should have known due to its experience, ability, qualifications, and expertise in the construction industry, that involves problems, conflicts, defects, deficiencies, inconsistencies, errors, or omissions in the Contract Documents and the Work to be constructed and, any variances between the Contract Documents and applicable laws, statutes, building codes, rules or regulations, without prior written notification to the Architect/Engineer and without prior authorization to proceed from the Architect/Engineer, the Contractor shall be responsible for and bear the costs and delays (including costs of any delay) of performing such Work and all corrective actions as directed by the Architect/Engineer.
  - 3.2.6.3. Any and all claims resulting from the Contractor's failure, including those of any subcontractor or supplier, to carefully review, evaluate, and become familiar with all aspects of the Contract Documents shall be deemed void and waived by the Contractor.
- 3.2.7. Sufficiency of Site Conditions: Prior to submission of its bid, and in all events prior to and upon signing the Contract, the Contractor certifies, warrants and guarantees that it has visited, carefully reviewed, evaluated, and become familiar with all aspects of the site and local conditions at which the Project is to be constructed. The Contractor agrees that the Contract Documents are an adequate, consistent, coordinated, and sufficient representation of the site and local conditions for the Work.
- 3.2.7.1. The Contractor has reviewed and become familiar with all aspects with the Site Survey and Geotechnical Report for the Project and has a full understanding of the information provided therein.
  - 3.2.7.2. If the Work involves modifications, renovations, or remodeling of an existing structure(s) or other man-made feature(s), the Contractor certifies, warrants and guarantees that it has

reviewed, evaluated, and become familiar with all available as-built and record drawings, plans and specifications, and has thoroughly inspected and become familiar with the structure(s) or man-made feature(s).

- 3.2.7.3. Any and all claims resulting from the Contractor's failure, including those of any subcontractor or supplier, to visit, carefully review, evaluate, and become familiar with all aspects of the site, available geotechnical information, and local conditions at which the Project is to be constructed shall be deemed void and waived by the Contractor.

### **3.3. SUPERVISION AND CONSTRUCTION PROCEDURES**

- 3.3.1. The Contractor shall supervise and direct the Work using the Contractor's best skill and attention recognizing that time and quality are of the essence of the Work. The Contractor shall be solely responsible for and have control over construction means, methods, techniques, sequences and procedures and for coordinating all portions of the Work under the Contract, unless the Contract Documents give other specific instructions concerning these matters. It is the responsibility of and incumbent upon the Contractor to ensure, confirm, coordinate, inspect and oversee all Work (which is inclusive of but not limited to all submittals, change orders, schedules, workmanship, and appropriate staffing with enough competent and qualified personnel) so that the Work is not impacted in terms of any delays, costs, damages, or additional time, or effort on the part Architect/Engineer or Owner. If the Contract Documents give specific instructions concerning construction means, methods, techniques, sequences or procedures, the Contractor shall evaluate the jobsite safety thereof and, except as stated below, shall be fully and solely responsible for the jobsite safety of such means, methods, techniques, sequences or procedures. If the Contractor determines that such means, methods, techniques, sequences or procedures may not be safe, the Contractor shall give timely written notice to the Owner and Architect/Engineer and shall not proceed with that portion of the Work without further written instructions from the Architect/Engineer. If the Contractor is then instructed to proceed with the required means, methods, techniques, sequences or procedures without acceptance of changes proposed by the Contractor, the Architect/Engineer or Owner as appropriate shall be solely responsible for any resulting loss or damage. The Contractor will be required to: review any specified construction or installation procedure; advise the Architect/Engineer if the specified procedure deviates from good construction practice; to advise the Architect/Engineer if following the procedure will affect any warranties, including the Contractor's general warranty, or of any objections the Contractor may have to the procedure and shall propose any alternative procedure which the Contractor will warrant and guarantee. The Contractor is required to: review any specified construction or installation procedure; advise the Architect/Engineer if the specified procedure deviates from good construction practice; to advise the Architect/Engineer if following the procedure will affect any warranties, including the Contractor's general warranty, or of any objections the Contractor may have to the procedure and to propose any alternative procedure which the Contractor will warrant.
- 3.3.2. The Contractor shall furnish management, supervision, coordination, labor and services that: (1) expeditiously, economically, and properly completes the Work; (2) comply with all requirements of the Contract Documents; and, (3) are performed in a quality workmanlike manner and in accordance with the standards currently practiced by persons and entities performing or providing comparable management, supervision, labor and services on projects of similar size, complexity, cost, and nature to this Project. However, the standards currently practiced within the construction industry shall not relieve the Contractor of the responsibility to perform the Work to the level of quality, detail, and excellence defined and intended by the Contract Documents as interpreted by the Architect/Engineer.
- 3.3.3. All services and labor rendered by the Contractor, including any subcontractors or suppliers, shall be performed under the immediate supervision at the site of persons possessing expertise and the requisite knowledge in the discipline or trade of service being rendered. The Contractor shall maintain such supervision and personnel at all times that the Contractor's personnel, subcontractors, and/or suppliers are at the site. The Contractor shall never be absent from the site during performance of any portion of the Work by any entity under the supervision and direction of the Contractor. Full time attendance by the Contractor from Notice to Proceed through Final Acceptance is an explicit requirement of this Contract.

- 3.3.4. The Contractor shall be responsible to the Owner for acts, damages, errors, and omissions of the Contractor's employees, subcontractors and their agents and employees, and other persons or entities performing portions of the Work for or on behalf of the Contractor or any of its Subcontractors.
- 3.3.5. The Contractor shall be responsible for inspection of portions of Work already performed to determine that such portions are in proper condition to receive subsequent Work.

### **3.4. LABOR, WAGES, AND MATERIALS**

- 3.4.1. Unless otherwise provided in the Contract Documents, the Contractor shall provide and pay for labor, materials, permits, licenses, goods, products, equipment, tools, construction equipment and machinery, water, heat, all utilities, transportation, and other facilities and services necessary for proper execution and completion of the Work in accordance with the Contract Documents, whether temporary or permanent and whether or not incorporated or to be incorporated in the Work.
- 3.4.2. The Contractor may make substitutions only with the consent of the Owner, after evaluation by the Architect/Engineer and in accordance with a Change Order. This opportunity to request substitutions does not negate or waive any requirement for the Contractor to follow a pre-bidding "prior approval" requirement nor obligate the Owner to approve any substitution request.
- 3.4.3. The Contractor shall enforce strict discipline, appropriate behavior, and good order among the Contractor's employees, subcontractors at every tier and level, and other persons carrying out the Contract. The Contractor shall not permit employment of unfit persons or persons not skilled in tasks assigned to them.
- 3.4.4. Prevailing Wages and Montana Residents.
  - 3.4.4.1. The Contractor and all subcontractors at any level or tier of the Work shall give preference to the employment of bona fide Montana residents in the performance of the Work and shall pay the standard prevailing rate of wages, including fringe benefits for health and welfare and pension contributions and travel allowance provisions in effect and applicable to the county or locality in which the work is being performed. (18-2-403, MCA)
  - 3.4.4.2. At least 50% of the workers, as defined by the Department of Labor & Industry (DOLI), must be bona fide Montana residents. (18-2-401, 18-2-402, MCA)
  - 3.4.4.3. Indian Employment Preference within the Boundaries of an Indian Reservation. All contractors that are awarded a state agency construction contract within the exterior boundaries of an Indian Reservation shall extend a hiring preference to qualified Indians as provided herein:
    - 3.4.4.3.1. "State agency" means a department, office, board, bureau, commission, agency, or other instrumentality of the executive or judicial branches of the government of this State. "Indian" means a person who is enrolled or who is a lineal descendent of a person enrolled in an enrollment listing of the Bureau of Indian Affairs or in the enrollment listing of a recognized Indian tribe domiciled in the United States.
    - 3.4.4.3.2. Qualified Indians – Employment Criteria: An Indian shall be qualified for employment in a permanent, temporary, or seasonal position if he or she has substantially equal qualifications for any position and resides on the reservation where the construction contract is to be performed.
    - 3.4.4.3.3. Non-Applicability: The Indian Employment Preference Policy does not apply to a project partially funded with federal-aid money from the United States Department of Transportation or when residency preference laws are specifically prohibited by federal law. It does not apply to independent contractors and their employees, student interns, elected officials, or appointed positions.
  - 3.4.4.4. The Commissioner of The Montana Department of Labor and Industry (DOLI) has established the standard prevailing rate of wages in accordance with 18-2-401 and 18-2-402, MCA. A copy of the Rates entitled "State of Montana, Prevailing Wage Rates" are bound herein. The Commissioner of the Montana DOLI has established the resident requirements in accordance with 18-2-409, MCA. The Contractor and all subcontractors at any level or tier of the Work

shall direct any and all questions concerning prevailing wage and Montana resident issues for all aspects of the Work to DOLI.

- 3.4.4.5. The Contractor and all subcontractors at any tier or level of the Work, and as determined by the Montana DOLI, shall classify all workers in the project in accordance with the State of Montana, Prevailing Wage Rates. In the event the Contractor is unable to classify a worker in accordance with these rates he shall contact DOLI for a determination of the classification and the prevailing wage rate to be paid.
- 3.4.4.6. The Contractor and all subcontractors at any tier or level of the Work shall be responsible for obtaining wage rates for all workers prior to their performing any work on the project. The Contractor is required to pay and insure that its subcontractors at any tier or level and others also pay the prevailing wage determined by the DOLI, insofar as required by Title 18 of the MCA and the pertinent rules and standards of DOLI.
- 3.4.4.7. It is not the responsibility of the Owner to determine who classifies as a subcontractor, sub-subcontractor, material man, supplier, or any other person involved in any aspect of the Work at any tier or level. All such determinations shall be the sole responsibility of the Contractor, subcontractors, sub-subcontractors, material men, suppliers and others involved in the project at any tier or level. The Contractor, subcontractors, sub-subcontractors, material men, suppliers and others involved in the project shall indemnify and hold harmless the Owner from all claims, attorneys' fees, damages and/or awards involving prevailing wage or Montana resident issues. Any changes to wages or penalties for failure to pay the correct wages will be the sole responsibility of the Contractor and/or his subcontractors and no further charges or claims shall be made to the Owner. If the parties mutually agree or an arbitrator or court determines that any change in wages is due and any part is attributable to the Owner, the Owner's sole liability shall be for the amount of wages ordered only and not for other expenses, charges, penalties, overhead, profit or other mark-ups.
- 3.4.4.8. In accordance with 18-2-422(1) MCA, each job classification's standard prevailing wage rate, including fringe benefits, that the contractors and employers shall pay during construction of the project is included herein by both reference to DOLI's "Building" or "Heavy/Highway" schedules and as part of these Contract Documents.
- 3.4.4.9. The Contractor and every employer, including all subcontractors at any tier or level, is required by 18-2-422(2) MCA to maintain payroll records in a manner readily capable of being certified for submission under 18-2-423 MCA, for a period of not less than 3 years after the contractor's, subcontractor's, or employer's completion of work on the project or the Final Acceptance by the Owner, whichever is later.
- 3.4.4.10. Each contractor is required by 18-2-422(3) MCA to post in a visible and accessible location a statement of all wages and fringe benefits in compliance with 18-2-423.

### **3.5. WARRANTY AND GUARANTEE**

- 3.5.1. The Contractor warrants to the Owner and Architect/Engineer that materials and equipment furnished under the Contract will be new and of good quality unless otherwise required or permitted by the Contract Documents, that the Work will be free from defects not inherent in the quality required or permitted, and that the Work will conform to the requirements of the Contract Documents. Work not conforming to these requirements, including substitutions not properly approved and authorized, may be considered defective and rejected. The Contractor's warranty excludes remedy for damage or defect caused by abuse, modifications not executed by the Contractor, improper or insufficient maintenance, improper operation, or normal wear and tear and normal usage. If required by the Architect/Engineer, the Contractor shall furnish satisfactory evidence as to the kind and quality of materials and equipment.
- 3.5.2. The Contractor shall and does hereby warrant and guarantee all work, workmanship, and materials for the full warranty period as specified in the Contract Documents. The warranty period shall be defined as commencing with Substantial Completion (or with each Substantial Completion if there is more than one) of the Project, or any portion thereof, and continuing for one (1) calendar year from the date of Final Acceptance of the entire project by the Owner. The date of Final Acceptance shall be the date of the

Architect/Engineer's signature on the final request for payment unless otherwise agreed upon in writing for the entire project or any portion thereof, by the Owner, Architect/Engineer and Contractor.

3.5.3. In addition to the one (1) calendar year warranty and guarantee specified in this herein above, the Contractor warrants and guarantees all materials and workmanship for the roofing system for a period of two (2) calendar years from the date of Final Acceptance. This warranty shall cover all labor and materials for roof and roofing finish systems (e.g. flashing, terminations, parapet caps, etc.) repairs from moisture penetration and/or defects in workmanship.

3.5.4. Manufacturer and product warranties and guarantees, as provided by the manufacturer or as specified in the Contract Documents, are in addition to the Contractor's warranty.

### **3.6. TAXES**

3.6.1. The Contractor is responsible for and shall pay all sales, consumer, use, and similar taxes for the Work provided by the Contractor which are legally enacted when bids are received or negotiations concluded, whether or not yet effective or merely scheduled to go into effect.

3.6.2. In compliance with 15-50-206 MCA, the Contractor will have 1% of his gross receipts withheld by the Owner from all payments due and sent to the Montana Department of Revenue. Each subcontractor who performs work greater than \$5,000 shall have 1% of its gross receipts withheld by the Contractor and sent to the Montana Department of Revenue. The Contractor shall notify the Department of Revenue on the Department's prescribed form.

### **3.7. PERMITS, FEES, AND NOTICES**

3.7.1. Unless otherwise provided in the Contract Documents, the Contractor shall secure and pay for the building permit and other permits and governmental fees, licenses and inspections necessary for proper execution and completion of the Work which are customarily secured after execution of the Contract, including but not limited to, the building permit fee, electrical, plumbing, sewer connection fee and mechanical permit fee, and any required impact fees and which are legally required when bids are received or negotiations concluded.

3.7.2. The Contractor shall comply with and give notices required by laws, ordinances, rules, regulations and lawful orders of public authorities applicable to performance of the Work.

3.7.3. If the Contractor performs Work knowing it to be contrary to laws, statutes, ordinances, building codes, and rules and regulations, and does so without providing notice to the Architect/Engineer and Owner, the Contractor shall assume responsibility for such Work and shall bear the costs attributable to correction. The Contractor shall be solely responsible to insure that all work it performs is in full compliance with all prevailing and applicable codes and regulations.

3.7.4. Incident Reporting: The Contractor shall immediately notify the Owner and Architect/Engineer, both orally and in writing, of the nature and details of all incidents which may adversely affect the quality or progress of the Work, including, but not limited to, union disputes, accidents, delays, damages to Work, and other significant occurrences. Such notices are in addition to any other notices required regarding claims.

### **3.8. ALLOWANCES**

3.8.1. The Contractor shall include in the Contract Sum all allowances stated in the Contract Documents. Items covered by allowances shall be supplied for such amounts and by such persons or entities as the Owner may direct.

3.8.2. Unless otherwise provided in the Contract Documents:

3.8.2.1. allowances shall cover the cost to the Contractor of materials and equipment delivered at the site and all required taxes, less applicable trade discounts;

3.8.2.2. Contractor's costs for unloading and handling at the site, labor, installation costs, overhead, profit and other expenses contemplated for stated allowance amounts shall be included by the Contractor in the Contract Sum but not in the allowances;

3.8.2.3. whenever costs are more than or less than stated allowances, the Contract Sum shall be adjusted accordingly by Change Order. The amount of the Change Order shall reflect: (1) the difference between actual costs and the allowances under Clause 3.8.2.1; and, (2) changes in Contractor's costs under Clause 3.8.2.2.

3.8.3. Materials and equipment under an allowance shall be selected by the Owner.

### **3.9. CONTRACTOR'S PERSONNEL**

3.9.1. The Contractor shall employ competent personnel, supervisors, project managers, project engineers, project superintendent, and all others who shall be assigned to the Work throughout its duration. Contractor's personnel extend to those employed by the Contractor whether at the site or not. The Owner shall have right to review and approve or reject all replacement of Contractor's personnel. All personnel assigned by the Contractor to the Work shall possess the requisite experience, skills, abilities, knowledge, and integrity to perform the Work.

3.9.2. The superintendent and others as assigned shall be in attendance at the Project site during the performance of any and all Work. The superintendent shall represent the Contractor. All communications given to the Contractor's personnel such as the project manager or the superintendent, whether verbal, electronic or written, shall be as binding as if given to the Contractor.

3.9.3. It is the Contractor's responsibility to appropriately staff, manage, supervise and direct the Work which is inclusive of the performance, acts, and actions of his personnel and subcontractors. As such, the Contractor further agrees to indemnify and hold harmless the Owner and the Architect/Engineer, and to protect and defend both from and against all claims, attorneys' fees, demands, causes of action of any kind or character, including the cost of defense thereof, arising in favor of or against the Owner, Architect/Engineer, Contractor, their agents, employees, or any third parties on account of the performance, behavior, acts or actions of the Contractor's personnel or subcontractors.

3.9.4. Prior to the commencement of any work, the Contractor shall prepare and submit a personnel listing and organizational chart in a format acceptable to the Owner which lists by name, phone number (including cell phone), job category, and responsibility the Contractor's key/primary personnel who will work on the Project. The Contractor shall promptly inform the Owner in writing of any proposed replacements, the reasons therefore, and the name and qualifications of any proposed replacements. The Owner shall have the right to reject any proposed replacements without cost or claim being made by the Contractor. The chart shall be provided to the Owner at the time of the pre-construction conference.

3.9.5. The Contractor shall immediately remove for the duration of the Project, any person making an inappropriate racial, sexual, or ethnic comment, statement, joke, or gesture toward any other individual.

3.9.6. The Contractor shall immediately remove for the duration of the Project, any person who is incompetent, careless, disruptive, or not working in harmony with others.

### **3.10. CONSTRUCTION SCHEDULES**

3.10.1. The Contractor shall, promptly after being awarded the Contract, prepare and submit for the Owner's and Architect/Engineer's information a Contractor's construction schedule for the Work. The schedule shall not exceed time limits current under the Contract Documents, shall be revised at appropriate intervals as required by the conditions of the Work and per the requirements of the Contract Documents, shall be related to the entire Project to the extent required by the Contract Documents, and shall provide for expeditious and practicable execution of the Work. The Contractor's schedule shall be in the "Critical Path Method" and shall show the Critical Path of the Work in sufficient detail to evaluate the Contractor's progress. A request for time extension by the Contractor will not be allowed unless a change in the Work is approved by the Owner and materially affects the Critical Path. It is the Contractor's responsibility to demonstrate that any time extensions requests materially affect the Critical Path.

- 3.10.2. The Contractor shall prepare and keep current, for the Architect/Engineer's approval, a schedule of submittals which is coordinated with the Contractor's Construction Schedule and allows the Architect/Engineer reasonable time to review submittals.
- 3.10.3. The Contractor shall perform the Work in accordance with the most recent schedule submitted to the Owner and Architect/Engineer.
- 3.10.4. The Contractor's operations (including but not limited to the Contractor's forces employed, sequences of operations, and methods of operation) at all times during the performance of the contract shall be: (a) subject to the review of the Owner or the Architect/Engineer; and, (b) sufficient to insure the completion of the Work within the specified performance period.
- 3.10.5. The Critical Path Method Construction Schedule prepared by the Contractor must be in a form that is acceptable to both the Architect/Engineer and the Owner.
  - 3.10.5.1. The Schedule shall show the estimated progress of the entire Project through the individual time periods allowed for completion of each discipline, trade, phase, section, and aspect of the Work. The Contractor shall provide written reports of all logic and resource loading data with the Schedule and with all updates to the Schedule.
  - 3.10.5.2. The Schedule shall show percent complete, progress to date, project work, and projected time to complete the work for all activities. The percent complete and minor schedule changes, including additions of activities, change orders, construction change directives, changes to sequences of activities and significant changes in activity demands must be shown by a revised Schedule. A written report providing details about the changes and what actions are anticipated to get the work completed in the contractual time period shall be submitted with the revised schedule.
  - 3.10.5.3. The Construction Schedule shall include coordinate dates for performance of all divisions of the Work, including shipping and delivery, off-site requirements and tasks, so the Work can be completed in a timely and orderly fashion consistent with the required dates of Substantial Completion and Final Acceptance.
  - 3.10.5.4. The Construction Schedule shall include: (i) the required commencement date, the required dates of Substantial Completion(s) and Final Acceptance for the complete Project and all phases (if any); (ii) any guideline and milestone dates required by the Owner or the Contract Documents; (iii) subcontractor and supplier schedules; (iv) a submittal schedule which allows sufficient time for review and action by the Architect/Engineer; (v) the complete sequence of all construction activities with start and completion dates; and, (vi) required decision dates.
  - 3.10.5.5. By receiving, reviewing, and/or commenting on the Construction Schedule or any portion thereof (including logic and resource loading), neither the Owner or Architect/Engineer assume any of the Contractor's responsibility or liability that the Schedule be coordinated or complete, or for timely and orderly completion of the Work.
  - 3.10.5.6. Receiving, reviewing, and/or commenting on the Schedule, any portion thereof, or any revision thereof, does not constitute an approval, acknowledgement, or acceptance of any duration, dates, milestones, or performance indicated therein.
  - 3.10.5.7. A printout of the Schedule's logic showing all activities and all resource loading is required with the Schedule and with all updates to the Schedule.
- 3.10.6. The Contractor shall review and compare, at a minimum on a weekly basis, the actual status of the Work against its Construction Schedule.
- 3.10.7. The Contractor shall routinely, frequently, and periodically (but not less than monthly) update and/or revise its Construction Schedule to show actual progress of the Work through the date of the update or revision, projected level of completion of each remaining activity, activities modified since the previous update or revision, and major changes in scope or logic. The updated/revised Schedule shall be accompanied by a narrative report which: (1) states and explains any modifications of the critical path, if



any, including any changes in logic; (2) defines problem areas and lists areas of anticipated delays; (3) explains the anticipated impact the change in the critical path or problems and delays will have on the entire Schedule and the completion of the Work; (4) provides corrective action taken or proposed; and, (5) states how problems or delays will be resolved in order to deliver the Work by the required phasing milestones (if any), Substantial Completion(s), and Final Acceptance dates.

- 3.10.8. Delay in Performance: If at any time the Contractor anticipates that performance of the Work will be delayed or has been delayed, the Contractor shall: (1) immediately notify the Architect/Engineer by separate and distinct correspondence of the probable cause and effect of the delay, and possible alternatives to minimize the delay; and, (2) take all corrective action reasonably necessary to deliver the Work by the required dates. Nothing in this paragraph or the Contract Documents shall be construed by the Contractor as a granting by the Architect/Engineer or Owner of constructive acceleration. The results of failure to anticipate delays, or to timely notify the Owner and Architect/Engineer of an anticipated or real delay, are entirely the responsibility of the Contractor whether compensable or not.
- 3.10.9. Early Completion: The Contractor may attempt to achieve Substantial Completion(s) on or before the date(s) required in the Contract. However, such early completion shall be for the Contractor's sole convenience and shall not create any real or implied additional rights to Contractor or impose any additional obligations on the Owner or Architect/Engineer. The Owner will not be liable for nor pay any additional compensation of any kind to the Contractor for achieving Substantial Completion(s) or Final Acceptance prior to the required dates as set forth in the Contract. The Owner will not be liable for nor pay any additional compensation of any kind should there be any cause whatsoever that the Contractor is not able to achieve Substantial Completion(s) earlier than the contractually required dates of Substantial Completion(s) or Final Acceptance.
- 3.10.10. Float in Schedule. Any and all float time in the Contractor's schedule, regardless of the path or activity, shall accrue to the benefit of the Owner and the Work, and not to the Contractor. Float also includes any difference shown between any early completion dates shown on the Contractor's Schedule for any phasing milestone(s), Substantial Completion(s) or Final Acceptance and the dates or durations as required by the Contract Documents.
- 3.10.11. Modification of Required Substantial Completion(s) or Final Acceptance Dates: Modification of the required dates shall be accomplished only by duly authorized, accepted, and approved change orders stating the new date(s) with specificity on the change order form. All rights, duties, and obligations, including but not limited to the Contractor's liability for actual, delay, and/or liquidated damages, shall be determined in relation to the date(s) as modified.

### **3.11. DOCUMENTATION AND AS-BUILT CONDITIONS AT THE SITE**

- 3.11.1. The Contractor shall maintain at the site for the Owner one record copy of the Drawings, Specifications, Addenda, Change Orders and other Modifications, in good order and accurately marked to record current field changes and selections made during construction, and one record copy of approved Shop Drawings, Product Data, Samples and similar required submittals. These shall be available to the Architect/Engineer or Owner at any time and shall be delivered to the Architect/Engineer for submittal to the Owner upon completion of the Work.
- 3.11.2. The Owner shall not be required to process final payment until all documentation and data required by the Contract Documents is submitted to and approved by the Architect/Engineer including, but not limited to, the As-Built Drawings. The Owner will not process any final request for payment until the Architect/Engineer has received and verified that the Contractor has performed the requirements pertaining to the as-built drawings.
- 3.11.3. The as-built drawings shall be neatly and clearly marked during construction to record all deviations, variations, changes, and alterations as they occur during construction along with such supplementary notes and details necessary to clearly and accurately represent the as-built condition. The as-built drawings shall be available at all times to the Owner, Architect/Engineer and Architect/Engineer's consultants.

### **3.12. SHOP DRAWINGS, PRODUCT DATA AND SAMPLES**

3.12.1. Definitions:

3.12.1.1. Shop Drawings are drawings, diagrams, schedules and other data specially prepared for the Work by the Contractor or a Subcontractor, Sub-subcontractor, manufacturer, supplier or distributor to illustrate some portion of the Work.

3.12.1.2. Product Data are illustrations, standard schedules, performance charts, instructions, brochures, diagrams and other information furnished by the Contractor to illustrate materials or equipment for some portion of the Work.

3.12.1.3. Samples are physical examples which illustrate materials, equipment or workmanship and establish standards by which the Work will be judged.

3.12.2. Shop Drawings, Product Data, Samples and similar submittals are not Contract Documents. The purpose of their submittal is to demonstrate for those portions of the Work for which submittals are required by the Contract Documents the way by which the Contractor proposes to conform to the information given and the design concept expressed in the Contract Documents. Review by the Architect/Engineer is subject to the limitations of Subparagraph 4.2.7. Informational submittals upon which the Architect/Engineer is not expected to take responsive action may be so identified in the Contract Documents. Submittals which are not required by the Contract Documents may be returned by the Architect/Engineer without action.

3.12.3. The Contractor shall review, approve, and submit to the Architect/Engineer, Shop Drawings, Product Data, Samples and similar submittals required by the Contract Documents within sixty (60) calendar days of being issued the Notice To Proceed unless noted otherwise and shall do so in such sequence as to cause no delay in the Work or in the activities of the Owner or of separate contractors. Any and all items submitted by the Contractor which are not marked as reviewed for compliance with the Contract Documents and approved by the Contractor, or in the opinion of the Architect/Engineer, have not been reviewed for compliance by the Contractor even if marked as such, may be returned by the Architect/Engineer without action and shall not result in any accusation or claim for delay or cost by the Contractor. Any submittal that, in the opinion of the Architect/Engineer, is incomplete in any area or detail may be rejected and returned to the Contractor. It is the responsibility of and incumbent upon the Contractor to ensure and confirm that all submittals are complete, accurate, and in conformance to the Contract Documents prior to submission.

3.12.4. By approving and submitting Shop Drawings, Product Data, Samples and similar submittals, the Contractor represents and guarantees to the Architect/Engineer and Owner that the Contractor has determined and verified materials, field measurements and field construction criteria related thereto, or will do so, and has checked and coordinated the information contained within such submittals with the requirements of the Work and of the Contract Documents.

3.12.5. The Contractor shall perform no portion of the Work for which the Contract Documents require submittal and review of Shop Drawings, Product Data, Samples or similar submittals until the respective submittal has been approved by the Architect/Engineer. Should the Contractor, Subcontractors or Sub-subcontractors install, construct, erect or perform any portion of the Work without approval of any requisite submittal, the Contractor shall bear the costs, responsibility, and delay for removal, replacement, and/or correction of any and all items, material, and /or labor.

3.12.6. The Work shall be in accordance with approved submittals except that the Contractor shall not be relieved of responsibility for deviations from requirements of the Contract Documents by the Architect/Engineer's approval of Shop Drawings, Product Data, Samples or similar submittals unless the Contractor has specifically informed the Architect/Engineer in writing of such deviation at the time of submittal and: (1) the Architect/Engineer has given written approval to the specific deviation as a minor change in the Work; or, (2) a Change Order or Construction Change Directive has been issued authorizing the deviation. The Contractor shall not be relieved of responsibility for errors or omissions in Shop Drawings, Product Data, Samples or similar submittals by the Architect/Engineer's approval thereof.

3.12.7. The Contractor shall direct specific attention, in writing or on re-submitted Shop Drawings, Product Data, Samples or similar submittals, to revisions other than those requested by the Architect/Engineer on previous submittals. In the absence of such written notice the Architect/Engineer's approval of a re-submission shall not apply to such revisions.

- 3.12.8. The Contractor shall not be required to provide professional services which constitute the practice of architecture or engineering unless such services are specifically required by the Contract Documents for a portion of the Work or unless the Contractor needs to provide such services in order to carry out the Contractor's responsibilities for construction means, methods, techniques, sequences and procedures. The Contractor shall not be required to provide professional services in violation of applicable law. If professional design services or certifications by a design professional related to systems, materials or equipment are specifically required of the Contractor by the Contract Documents, the Owner and the Architect/Engineer will specify all performance and design criteria that such services must satisfy. The Contractor shall cause such services or certifications to be provided by a properly licensed design professional, whose signature and seal shall appear on all drawings, calculations, specifications, certifications, Shop Drawings and other submittals prepared by such professional. Shop Drawings and other submittals related to the Work designed or certified by such professional, if prepared by others, shall bear such professional's written approval when submitted to the Architect/Engineer. The Owner and the Architect/Engineer shall be entitled to rely upon the adequacy, accuracy and completeness of the services, certifications or approvals performed by such design professionals, provided the Owner and Architect/Engineer have specified to the Contractor all performance and design criteria that such services must satisfy. Pursuant to this subparagraph, the Architect/Engineer will review, approve or take other appropriate action on submittals only for the limited purpose of checking for conformance with information given and the design concept expressed in the Contract Documents. The Contractor shall not be responsible for the adequacy of the performance or design criteria required by the Contract Documents but shall be responsible and held liable for review and verification of all performance or design criteria as required by Paragraph 3.2.
- 3.12.9. Unless noted otherwise in the Contract Documents, the Contractor shall submit to the Architect/Engineer within sixty (60) days from the date of the Notice To Proceed a minimum of six (6) complete copies of all shop/setting drawings, schedules, cut sheets, products, product data, and samples required for the complete Work. Copies shall be reviewed, marked, stamped and approved on each and every copy by the Contractor prior to submission to the Architect/Engineer or they shall be returned without review or action. The Architect/Engineer shall review with reasonable promptness, making corrections, rejections, or other actions as appropriate. The Architect/Engineer's approval or actions on shop/setting drawings, schedules, cut sheets, products, product data, or samples shall not relieve the Contractor from responsibility for, nor deviating from, the requirements of the plans and specifications. Any deviations from the plans and specifications requested or made by the Contractor shall be brought promptly to the attention of the Architect/Engineer.
- 3.12.10. Cost for Re-Submissions: the Contractor is responsible for ensuring that all shop drawings, product data, samples, and submittals contain all information required by the Contract Documents to allow the Architect/Engineer to take action. The Contractor shall pay the Architect/Engineer's cost for any re-submission of any rejected item. Such costs shall be deducted from the contract sum by Change Order. The Contractor agrees that any action taken by the Architect/Engineer is solely in the Architect/Engineer's discretion and is non-negotiable for the purposes of the Architect/Engineer's cost recovery for multiple (i.e. more than one) review.

### **3.13. USE OF SITE**

- 3.13.1. The Contractor shall confine operations at the site to areas permitted by law, ordinances, permits and the Contract Documents and shall not unreasonably encumber the site with materials or equipment.
- 3.13.2. The Contractor shall not damage, endanger, compromise or destroy any part of the Project or the site, including but not limited to work performed by others, monuments, stakes, bench marks, survey points, utilities, existing features or structures. The Contractor shall be fully and exclusively responsible for and bare all costs and delays (including and costs of delay) for any damage, endangerment, compromise, or destruction of any part of the Project or site.

### **3.14. CUTTING AND PATCHING**

- 3.14.1. The Contractor shall be responsible for cutting, fitting or patching required to complete the Work or to make its parts fit together properly.

- 3.14.2. The Contractor shall not damage or endanger a portion of the Work or fully or partially completed construction of the Owner or separate contractors by cutting, patching or otherwise altering such construction, or by excavation. The Contractor shall not cut or otherwise alter such construction by the Owner or a separate contractor except with written consent of the Owner and of such separate contractor; such consent shall not be unreasonably withheld. The Contractor shall not unreasonably withhold from the Owner or a separate contractor the Contractor's consent to cutting or otherwise altering the Work.

### **3.15. CLEAN UP AND SITE CONTROL**

- 3.15.1. The Contractor shall keep the premises and surrounding area free from accumulation of waste materials or rubbish caused by operations under the Contract during performance of the Work and at the direction of the Owner or Architect/Engineer. At completion of the Work, the Contractor shall remove from and about the Project waste materials, rubbish, the Contractor's tools, construction equipment, machinery and surplus materials.
- 3.15.2. If the Contractor fails to clean up as provided in the Contract Documents, the Owner may do so and the cost thereof shall be charged to the Contractor.

### **3.16. ACCESS TO WORK**

- 3.16.1. The Contractor shall provide the Owner and Architect/Engineer access to the Work at all times wherever located.

### **3.17. ROYALTIES, PATENTS AND COPYRIGHTS**

- 3.17.1. The Contractor shall pay all royalties and license fees. The Contractor shall defend suits or claims for infringement of copyrights and patent rights and shall hold the Owner and Architect/Engineer harmless from loss on account thereof, but shall not be responsible for such defense or loss when a particular design, process or product of a particular manufacturer or manufacturers is required by the Contract Documents or where the copyright violations are contained in Drawings, Specifications or other documents prepared by the Owner or Architect/Engineer. However, if the Contractor has reason to believe that the required design, process or product is an infringement of a copyright or a patent, the Contractor shall be responsible for such loss unless such information is promptly furnished to the Architect/Engineer.

### **3.18. INDEMNIFICATION**

- 3.18.1. To the fullest extent permitted by law, the Contractor shall indemnify and hold harmless the Owner, Architect/Engineer, Architect/Engineer's consultants, and agents and employees of any of them from and against claims, damages, losses and expenses, including but not limited to attorneys' fees, arising out of or resulting from performance of the Work to the extent caused by the negligent acts or omissions of the Contractor, a Subcontractor, anyone directly or indirectly employed by them or anyone for whose acts they may be liable, regardless of whether or not such claim, damage, loss or expense is caused in part by a party indemnified hereunder. Such obligation shall not be construed to negate, abridge, or reduce other rights or obligations of indemnity which would otherwise exist as to a party or person described in this Paragraph. The Contractor agrees that it will defend, protect, indemnify and save harmless the State of Montana and the Owner against and from all claims, liabilities, demands, causes of action, judgments (including costs and reasonable attorneys' fees), and losses from any cause whatever (including patent, trademark and copyright infringement) except the Owner's sole or partial negligence. This includes any suits, claims, actions, losses, costs, damages of any kind, including the State and Owner's legal expenses, arising out of, in connection with, or incidental to the Contract, but does not include any such suits, claims, actions, losses, costs or damages which are the result of the negligent acts, actions, losses, costs, or damages which are acts, omissions or misconduct of the Owner if they do not arise out of, depend upon or relate to a negligent act, omission or misconduct of the Contractor in whole or in part.
- 3.18.2. In claims against any person or entity indemnified under this Paragraph 3.18 by an employee of the Contractor, a Subcontractor, anyone directly or indirectly employed by them or anyone for whose acts they may be liable, the indemnification obligation under Subparagraph 3.18.1 shall not be limited by a limitation on amount or type of damages, compensation or benefits payable by or for the Contractor or a Subcontractor under workers' compensation acts, disability benefit acts or other employee benefit acts.

## **ARTICLE 4 – ADMINISTRATION OF THE CONSTRUCTION CONTRACT**

### **4.1. THE ARCHITECT/ENGINEER**

- 4.1.1. The Architect/Engineer is the person lawfully licensed to practice or an entity lawfully practicing identified as such in the Agreement with the Owner and is referred to throughout the Contract Documents as if singular in number. The term “Architect/Engineer” means the Architect/Engineer’s duly authorized representative.
- 4.1.2. Duties, responsibilities and limitations of authority of the Architect/Engineer as set forth in the Contract Documents shall not be restricted, modified or extended without written consent of the Owner.
- 4.1.3. If the employment of the Architect/Engineer is terminated, the Owner shall employ a new Architect/Engineer at the sole choice and discretion of the Owner, whose status under the Contract Documents shall be that of the former Architect/Engineer.

### **4.2. ARCHITECT/ENGINEER’S ADMINISTRATION OF THE CONSTRUCTION CONTRACT**

- 4.2.1. The Architect/Engineer will provide administration of the Contract as described in the Contract Documents, and will be an Owner’s representative throughout the complete duration of the Project, including the warranty period. The Architect/Engineer will have authority to act on behalf of the Owner only to the extent provided in the Contract Documents, unless otherwise modified in writing in accordance with the Architect/Engineer Contract.
- 4.2.2. The Architect/Engineer, as a representative of the Owner, will visit the site at intervals appropriate to the stage of the Contractor’s operations to: (1) become generally familiar with and to keep the Owner informed about the progress and quality of the portion of the Work completed; (2) endeavor to guard the Owner against defects and deficiencies in the Work; and, (3) to determine in general if the Work is being performed in a manner indicating that the Work, when fully completed, will be in accordance with the Contract Documents. However, the Owner and Architect/Engineer will not be required to make exhaustive or continuous on-site inspections to check the quality or quantity of the Contractor’s Work. The Owner and Architect/Engineer will neither have control over or charge of, nor be responsible for, the construction means, methods, techniques, sequences or procedures, for the safety of any person involved in the work, or for the safety precautions and programs in connection with the Work, since these are solely the Contractor’s rights and responsibilities under the Contract Documents.
- 4.2.3. The Architect/Engineer will not be responsible for the Contractor’s failure to perform the Work in accordance with the requirements of the Contract Documents. The Architect/Engineer will not have control over or charge of and will not be responsible for acts or omissions of the Contractor, Subcontractors, or their agents or employees, or any other persons or entities performing portions of the Work.
- 4.2.4. Communications Facilitating Contract Administration. Except as otherwise provided in the Contract Documents or when direct communications have been specially authorized, the Owner and Contractor shall endeavor to communicate with each other through the Architect/Engineer about matters arising out of or relating to the Contract. Communications by and with the Architect/Engineer’s consultants shall be through the Architect/Engineer. Communications by and with Subcontractors and material suppliers shall be through the Contractor to the Architect/Engineer. Communications by and with separate contractors shall be through the Owner to the Architect/Engineer.
- 4.2.5. Based on the Architect/Engineer’s evaluations of the Contractor’s Applications for Payment, the Architect/Engineer will review and certify the amounts due the Contractor and will issue Certificates for Payment in such amounts. The Contractor is fully aware that the Owner (i.e. the State of Montana) has established a billing cycle for processing payments in Article 9 of these General Conditions. The Contractor and all Subcontractors are subject to all provisions of Title 28, Chapter 2, Part 21 MCA regarding all aspects of the Work.
- 4.2.6. The Architect/Engineer will have authority to reject Work that does not conform to the Contract Documents. Whenever the Architect/Engineer considers it necessary or advisable, the Architect/Engineer

will have authority to require inspection or testing of the Work in accordance with the General Conditions and any applicable technical specification requirements, whether or not such Work is fabricated, installed or completed. However, neither this authority of the Architect/Engineer nor a decision made in good faith either to exercise or not to exercise such authority shall give rise to a duty or responsibility of the Architect/Engineer to the Contractor, Subcontractors, material and equipment suppliers, their agents or employees, or other persons or entities performing portions of the Work.

- 4.2.7. The Architect/Engineer will review and approve or take other appropriate action upon the Contractor's submittals such as Shop Drawings, Product Data and Samples, but only for the limited purpose of checking for conformance with information given and the design concept expressed in the Contract Documents. The Architect/Engineer's action will be taken with such reasonable promptness as to cause no delay in the Work or in the activities of the Owner, Contractor or separate contractors, while allowing sufficient time in the Architect/Engineer's professional judgment to permit adequate review. Review of such submittals is not conducted for the purpose of determining the accuracy and completeness of other details such as dimensions and quantities, or for substantiating instructions for installation or performance of equipment or systems, all of which remain the responsibility of the Contractor as required by the Contract Documents. The Architect/Engineer's review of the Contractor's submittals shall not relieve the Contractor of the obligations under Paragraphs 3.3, 3.5 and 3.12. The Architect/Engineer's review shall not constitute approval of safety precautions or, unless otherwise specifically stated by the Architect/Engineer, of any construction means, methods, techniques, sequences or procedures. The Architect/Engineer's approval of a specific item shall not indicate approval of an assembly of which the item is a component.
- 4.2.8. The Architect/Engineer will prepare Change Orders and Construction Change Directives, and may authorize minor changes in the Work as provided in Paragraph 7.4.
- 4.2.9. The Architect/Engineer will conduct inspections to determine the date or dates of Substantial Completion(s) and the date of Final Acceptance, will receive and forward to the Owner, for the Owner's review and records, written warranties and related documents required by the Contract and assembled by the Contractor, and will issue a final Certificate for Payment upon compliance with the requirements of the Contract Documents.
- 4.2.10. If the Owner and Architect/Engineer agree, the Architect/Engineer will provide one or more project representatives to assist in carrying out the Architect/Engineer's responsibilities. The duties, responsibilities and limitations of authority of such project representatives shall be as set forth in the Owner's Agreement with the Architect/Engineer.
- 4.2.11. The Architect/Engineer will interpret and decide matters concerning performance under and requirements of the Contract Documents on written request of either the Owner or Contractor. The Architect/Engineer's response to such requests will be made in writing within any time limits agreed upon or otherwise with reasonable promptness. If no agreement is made concerning the time within which interpretations required of the Architect/Engineer shall be furnished in compliance with this Paragraph 4.2, then delay shall not be recognized on account of failure by the Architect/Engineer to furnish such interpretations until 15 days after written request is made for them.
- 4.2.12. Interpretations and decisions of the Architect/Engineer will be consistent with the intent of and reasonably inferable from the Contract Documents and will be in writing or in the form of drawings. When making such interpretations and initial decisions, the Architect/Engineer will endeavor to secure faithful performance by both Owner and Contractor, will not show partiality to either and will render such interpretations and decisions in good faith.
- 4.2.13. The Architect/Engineer's decisions on matters relating to aesthetic effect will be final if consistent with the intent expressed in the Contract Documents.
- 4.2.14. The Architect/Engineer's or Owner's observations or inspections do not alleviate any responsibility on the part of the Contractor. The Architect/Engineer and the Owner reserves the right to observe and inspect the work and make comment. Action or lack of action following observation or inspection is not to be construed as approval of Contractor's performance.

### **4.3. CLAIMS AND DISPUTES**

- 4.3.1. Definition. A Claim is a demand or assertion by one of the parties seeking, as a matter of right, adjustment or interpretation of Contract terms, payment of money, extensions of time or other relief with respect to the terms of the Contract. The term "Claim" also includes other disputes, controversies, and matters in question between the Owner and Contractor arising out of or relating to the Contract. Claims must be initiated by written notice. The responsibility to substantiate Claims shall rest solely with the party making the Claim.
- 4.3.1.1. Time Limits on Claims. Claims by either party must be initiated within 21 calendar days after occurrence of the event giving rise to such claim. The following shall apply to the initiation of a claim:
- 4.3.1.1.1. A written notice of a claim must be provided to the Architect/Engineer and the other party within 21 calendar days after the occurrence of the event or the claim is waived by the claiming party and void in its entirety.
- 4.3.1.1.2. Claims must be initiated by separate, clear, and distinct written notice within the 21 calendar day time frame to the Architect/Engineer and the other party and must contain the notarized statement in Sub-Paragraph 4.3.1.5 when the claim is made by the Contractor. Discussions in any form with the Architect/Engineer or Owner, whether at the site or not, do not constitute initiation of a claim. Notes in project meeting minutes, email correspondence, change order proposals, or any other form of documentation does not constitute initiation of a claim. The written notice must be a separate and distinct correspondence provided in hardcopy to both the Architect/Engineer and Owner and must delineate the specific event and outline the causes and reasons for the claim whether or not cost or time have been fully determined. Written remarks or notes of a generic nature are invalid in their entirety. Comments made at progress meetings, project site visits, inspections, emails, voice mails, and other such communications do not meet the requirement of providing notice of claim.
- 4.3.1.1.3. Physical Injury or Physical Damage. Should the Owner or Contractor suffer physical injury or physical damage to person or property because of any error, omission, or act of the other party or others for whose acts the other party is legally and contractually liable, claim will be made in writing to the other party within a reasonable time of the first observance of such physical injury or physical damage but in no case beyond 30 calendar days of the first observance. The notice shall provide sufficient detail to enable the other party to investigate the matter. The provisions of this paragraph shall not be construed as a substitute for or a waiver of the provisions of any applicable statute of limitations or repose. In all such cases, the indemnification provisions of the Contract shall be effectual and the Contractor's insurance shall be primary and in full effect.
- 4.3.1.2. All Claims must contain sufficient justification and substantiation with the written notice or they may be rejected without consideration by the Architect/Engineer or other party with no additional impact or consequence to the Contract Sum, Contract Time, or matter(s) in question in the Claim.
- 4.3.1.3. If additional compensation is claimed, the exact amount claimed and a breakdown of that amount into the following categories shall be provided with each and every claim:
- 4.3.1.3.1. Direct costs (as listed in Subparagraph 7.3.9.1 through 7.3.9.5);
- 4.3.1.3.2. Indirect costs (as defined in Paragraph 7.2.5); and,
- 4.3.1.3.3. Consequential items (i.e. time extensions, credits, logic, reasonableness, impacts, disruptions, dilution) for the change.
- 4.3.1.4. If additional time is claimed the following shall be provided with each and every claim:
- 4.3.1.4.1. The specific number of days and specific dates for which the additional time is sought;
- 4.3.1.4.2. The specific reasons, causes, and/or effects whereby the Contractor believes that additional time should be granted; and,

4.3.1.4.3. The Contractor shall provide analyses, documentation, and justification of its claim for additional time in accordance with the latest Critical Path Method schedule in use at the time of event giving rise to the claim.

4.3.1.5. With each and every claim, the Contractor shall submit to the Architect/Engineer and Owner a notarized statement containing the following language:

"Under penalty of law (including perjury and/or false/fraudulent claims against the State), the undersigned,

\_\_\_\_\_  
(Name) (Title)

Of \_\_\_\_\_  
(Company) (Date)

hereby certifies, warrants, and guarantees that this claim made for Work on this Contract is a true statement of the costs, adjustments and/or time sought and is fully documented and supported under the contract between the parties.

\_\_\_\_\_  
(Signature) (Date)"

4.3.2. Continuing Contract Performance.

4.3.2.1. Pending final resolution of a Claim except as otherwise agreed in writing or as provided in Subparagraph 9.7.1 and Article 14, the Contractor shall proceed diligently with performance of the Contract and the Owner shall continue to make payments in accordance with the Contract Documents on the portion of the Work not involved in a Claim.

4.3.3. Claims for Cost or Time for Concealed or Unknown Conditions.

4.3.3.1. If conditions are encountered at the site which are: (1) subsurface or otherwise concealed physical conditions which differ materially from those indicated in the Contract Documents; or, (2) unknown physical conditions of an unusual nature, which differ materially from those ordinarily found to exist and generally recognized as inherent in construction activities of the character provided for in the Contract Documents, then notice by the observing party shall be given to the other party promptly before conditions are disturbed.

4.3.3.2. The Architect/Engineer will promptly investigate such conditions and, if they differ materially and cause an increase or decrease in the Contractor's cost of, or time required for, performance of any part of the Work, will recommend an equitable adjustment in the Contract Sum or Contract Time, or both. If the Architect/Engineer determines that the conditions at the site are not materially different from those indicated in the Contract Documents and that no change in the terms of the Contract is justified, the Architect/Engineer shall so notify the Owner and Contractor in writing, stating the reasons. Claims by either party in opposition to such determination must be made within 21 days after the date of the Architect/Engineer's decision.

4.3.3.3. If the conditions encountered are materially different, the Contract Sum and Contract Time shall be equitably adjusted, but if the Owner and Contractor cannot agree on an adjustment in the Contract Sum or Contract Time, the adjustment shall be referred to the Architect/Engineer for initial determination, subject to further proceedings pursuant to Paragraph 4.4.

4.3.3.4. Nothing in this paragraph shall relieve the Contractor of its obligation to adequately and sufficiently investigate, research, and examine the site, the site survey, topographical information, and the geotechnical information available whether included by reference or fully incorporated in the Contract Documents.

4.3.4. Claims for Additional Cost.



- 4.3.4.1. If the Contractor wishes to make Claim for an increase in the Contract Sum, written notice as provided herein shall be given before proceeding to execute the Work. Prior notice is not required for Claims relating to an emergency endangering life or property arising under Paragraph 10.6.
- 4.3.4.2. If the Contractor believes additional cost is involved for reasons including but not limited to: (1) a written interpretation from the Architect/Engineer; (2) an order by the Owner to stop the Work solely for the Owner's convenience or where the Contractor was not at least partially at fault; (3) a written order for a minor change in the Work issued by the Architect/Engineer; (4) failure of payment by the Owner per the terms of the Contract; (5) termination of the Contract by the Owner; or, (6) other reasonable grounds, Claim must be filed in accordance with this Paragraph 4.3.

#### 4.3.5. Claims for Additional Time

- 4.3.5.1. If the Contractor wishes to make Claim for an increase in the Contract Time, written notice as specified in these General Conditions shall be provided along with the notarized certification. The Contractor's Claim shall include an estimate of cost and of probable effect of delay on progress of the Work. In the case of a continuing delay for the same event or cause only one Claim is necessary. However, separate and distinct written notice is required for each separate event.

#### 4.3.5.2. Weather Delays:

- 4.3.5.2.1. If adverse weather conditions are the basis for a Claim for additional time, such Claim shall be documented by data substantiating that weather conditions were abnormal for the period of time, could not have been reasonably anticipated, and had an adverse effect on the scheduled construction activities.
- 4.3.5.2.2. Inclement or adverse weather shall not be a prima facie reason for the granting of an extension of time, and the Contractor shall make every effort to continue work under prevailing conditions. The Owner may grant an extension of time if an unavoidable delay occurs as a result of inclement/severe/adverse weather and such shall then be classified as a "Delay Day". Any and all delay days granted by the Owner are and shall be non-compensable in any manner or form. The Contractor shall comply with the notice requirements concerning instances of inclement/severe/adverse weather before the Owner will consider a time extension. Each day of inclement/severe/adverse weather shall be considered a separate instance or event and as such, shall be subject to the notice requirements.
- 4.3.5.2.3. An "inclement", "severe", or "adverse" weather delay day is defined as a day on which the Contractor is prevented by weather or conditions caused by weather resulting immediately there from, which directly impact the current controlling critical-path operation or operations, and which prevent the Contractor from proceeding with at least 75% of the normal labor and equipment force engaged on such critical path operation or operations for at least 60% of the total daily time being currently spent on the controlling operation or operations.
- 4.3.5.2.4. The Contractor shall consider normal/typical/seasonal weather days and conditions caused by normal/typical/seasonal weather days for the location of the Work in the planning and scheduling of the Work to ensure completion within the Contract Time. No time extensions will be granted for the Contractor's failure to consider and account for such weather days and conditions caused by such weather for the Contract Time in which the Work is to be accomplished.
- 4.3.5.2.5. A "normal", "typical", or "seasonal" weather day shall be defined as weather that can be reasonably anticipated to occur at the location of the Work for each particular month involved in the Contract Time. Each month involved shall not be considered individually as it relates to claims for additional time due to inclement/adverse/severe weather but shall consider the entire Contract Time as it compares to normal/typical/seasonal weather that is reasonably anticipated to occur. Normal/typical/seasonal weather days shall be based upon U.S. National

Weather Service climatic data for the location of the Work or the nearest location where such data is available.

4.3.5.2.6. The Contractor is solely responsible to document, prepare and present all data and justification for claiming a weather delay day. Any and all claims for weather delay days shall be tied directly to the current critical-path operation or operations on the day of the instance or event which shall be delineated and described on the Critical-Path Schedule and shall be provided with any and all claims. The Contractor is solely responsible to indicate and document why the weather delay day(s) claimed are beyond those weather days which are reasonably anticipated to occur for the Contract Time. Incomplete or inaccurate claims, as determined by the Architect/Engineer or Owner, may be returned without consideration or comment.

4.3.5.3. Where the Contractor is prevented from completing any part of the Work with specified durations or phases due to delay beyond the control of both the Owner and the Contractor, an extension of the contract time or phase duration in an equal amount to the time lost due to such delay shall be the Contractor's sole and exclusive remedy for such delay.

4.3.5.4. Delays attributable to and/or within the control of subcontractors and suppliers are deemed to be within the control of the Contractor.

4.3.5.5. In no event shall the Owner be liable to the Contractor, any subcontractor, any supplier, Contractor's surety, or any other person or organization, for damages or costs arising out of or resulting from: (1) delays caused by or within the control of the Contractor which include but are not limited to labor issues or labor strikes on the Project, federal, state, or local jurisdiction enforcement actions related directly to the Contractor's Work (e.g. safety or code violations, etc.); or, (2) delays beyond the control of both parties including but not limited to fires, floods, earthquakes, abnormal weather conditions, acts of God, nationwide material shortages, actions or inaction by utility owners, emergency declarations by federal, state, or local officials enacted in the immediate vicinity of the project, or other contractors performing work for the Owner.

#### 4.3.6. Claims for Consequential Damages

4.3.6.1. The Contractor and Owner waive Claims against each other for consequential damages arising out of or relating to this Contract. This mutual waiver includes:

4.3.6.1.1. damages incurred by the Owner for losses of use, income, profit, financing, business and reputation, and for loss of management or employee productivity or of the services of such persons; and,

4.3.6.1.2. damages incurred by the Contractor for principal office expenses including the compensation of personnel stationed there, for losses of financing, business and reputation, income, and for loss of profit.

4.3.6.2. This mutual waiver is applicable, without limitation, to all consequential damages due to either party's termination in accordance with Article 14. Nothing contained in this waiver of consequential damages shall be deemed to preclude an award of liquidated or actual damages, when applicable, in accordance with the requirements of the Contract Documents.

#### **4.4. RESOLUTION OF CLAIMS, DISPUTES, AND CONTROVERSIES**

4.4.1. Decision of Architect/Engineer. Claims, including those alleging an error or omission by the Architect/Engineer, shall be referred initially to the Architect/Engineer for decision. A decision by the Architect/Engineer shall be required as a condition precedent to mediation, arbitration or litigation of all Claims between the Contractor and Owner arising prior to the date of Final Acceptance, unless 30 days have passed after the Claim has been referred to the Architect/Engineer with no decision having been rendered by the Architect/Engineer. The Architect/Engineer will not decide disputes between the Contractor and persons or entities other than the Owner. Any Claim arising out of or related to the Contract, except those already waived in Subparagraphs 4.3.6, 7.2.6, 7.3.8, 9.10.4 and 9.10.5 shall, pending compliance with Subparagraph 4.4.5, be subject to mediation, arbitration, or the institution of

legal or equitable proceedings. Claims waived in Subparagraphs 4.3.6, 7.2.6, 7.3.8, 9.10.4, and 9.10.5 are deemed settled, resolved, and completed.

- 4.4.2. The Architect/Engineer will review Claims and within ten (10) days of the receipt of the Claim take one or more of the following actions: (1) request additional supporting data from the claimant or a response with supporting data from the other party; (2) reject the Claim in whole or in part; (3) approve the Claim; (4) suggest a compromise; or (5) advise the parties that the Architect/Engineer is unable to resolve the Claim if the Architect/Engineer lacks sufficient information to evaluate the merits of the Claim or if the Architect/Engineer concludes that, in the Architect/Engineer's sole discretion, it would be inappropriate for the Architect/Engineer to resolve the Claim.
- 4.4.3. If the Architect/Engineer requests a party to provide a response to a Claim or to furnish additional supporting data, such party shall respond within ten (10) days after receipt of such request and shall either provide a response on the requested supporting data, advise the Architect/Engineer when the response or supporting data will be furnished, or advise the Architect/Engineer that no supporting data will be furnished. Upon either no response or receipt of the response or supporting data, the Architect/Engineer will either reject or approve the Claim in whole or in part.
- 4.4.4. The Architect/Engineer will approve or reject Claims by written decision, which shall state the reasons therefore and which shall notify the parties of any change in the Contract Sum or Contract Time or both. The approval or rejection of a Claim by the Architect/Engineer shall be final and binding on the parties but subject to mediation and arbitration.
- 4.4.5. When 30 days have passed upon submission of a Claim without decision or action by the Architect/Engineer, or the Architect/Engineer has rendered a decision or taken any of the actions identified in Subparagraph 4.4.2, a demand for arbitration of a Claim covered by such decision or action must be made within 30 days after the date of expiration of Subparagraph 4.4.1 or within 30 days of the Architect/Engineer's decision or action. Failure to demand arbitration within said 30 day period shall result in the Architect/Engineer's decision becoming final and binding upon the Owner and Contractor whenever such decision is rendered.
- 4.4.6. If the Architect/Engineer renders a decision after arbitration proceedings have been initiated, such decision may be entered as evidence but shall not supersede arbitration proceedings unless the decision is acceptable to all parties concerned.
- 4.4.7. Upon receipt of a Claim against the Contractor or at any time thereafter, the Architect/Engineer or the Owner may, but is not obligated to, notify the surety, if any, of the nature and amount of the Claim. If the Claim relates to a possibility of a Contractor's default, the Architect/Engineer or the Owner may, but is not obligated to, notify the surety and request the surety's assistance in resolving the controversy.
- 4.4.8. A Claim subject to or related to liens or bonds shall be governed by applicable law regarding notices, filing deadlines, and resolution of such Claim prior to any resolution of such Claim by the Architect/Engineer, by mediation, or by arbitration, except for claims made by the Owner against the Contractor's bonds.

#### **4.5. MEDIATION**

- 4.5.1. Any Claim arising out of or related to the Contract, except Claims relating to aesthetic effect and except those waived as provided for in Subparagraphs 4.3.6, 7.2.6, 7.3.8, 9.10.4 and 9.10.5 shall, after initial decision by the Architect/Engineer or 30 days after submission of the Claim to the Architect/Engineer, be subject to mediation as a condition precedent to arbitration or the institution of legal or equitable proceedings by either party.
- 4.5.2. The parties shall endeavor to resolve their Claims by mediation which, unless the parties mutually agree otherwise, shall be in accordance with the Construction Industry Mediation Rules of the American Arbitration Association currently in effect and/or those rules specified in the contract documents or separately agreed upon between the parties. Construction Industry Mediation Rule M-2 (filing with AAA) is void. The parties shall mutually agree upon a mediator who shall then take the place of AAA in the Construction Industry Mediation Rules. The parties must mutually agree to use AAA and no filing of a request for mediation shall be made to AAA by either party until such mutual agreement has been made.

Request for mediation shall be filed in writing with the other party to the Contract and with the American Arbitration Association. The request may be made concurrently with the filing of a demand for arbitration but, in such event, mediation shall proceed in advance of arbitration or legal or equitable proceedings, which shall be stayed pending mediation for a period of 60 days from the date of filing, unless stayed for a longer period by agreement of the parties or court order.

- 4.5.3. The parties shall share the mediator's fee and any filing fees equally. The mediation shall be held in the place where the Project is located, unless another location is mutually agreed upon. Agreements reached in mediation shall be enforceable as settlement agreements in any court having jurisdiction thereof.

#### **4.6. ARBITRATION**

- 4.6.1. Any controversy or Claim arising out of or related to this Contract or the breach thereof shall be settled by arbitration in accordance with the Montana Uniform Arbitration Act (MUAA). To the extent it does not conflict with the MUAA, the Construction Industry Arbitration Rules of the American Arbitration Association shall apply except as modified herein. The parties to the arbitration shall bear their own costs and expenses for participating in the arbitration. Costs of the Arbitration panel shall be borne equally between the parties except those costs awarded by the Arbitration panel (including costs for the arbitration itself).
- 4.6.2. Prior to the arbitration hearing all parties to the arbitration may conduct discovery subject to the provisions of Montana Rules of Civil Procedure. The arbitration panel may award actual damages incurred if a party fails to provide full disclosure under any discovery request. If a party claims a right of information privilege protected by law, the party must submit that claim to the arbitration panel for a ruling, before failing to provide information requested under discovery or the arbitration panel may award actual damages.
- 4.6.3. The venue for all arbitration proceedings required by this Contract shall be the seat of the county in which the work occurs or the First Judicial District, Lewis & Clack County, as determined solely by the Owner. Arbitration shall be conducted by a panel comprised of three members with one selected by the Contractor, one selected by the Owner, and one selected by mutual agreement of the Owner and the Contractor.
- 4.6.4. Any Claim arising out of or related to the Contract, except Claims relating to aesthetic effect and except those waived as provided for in Subparagraphs 4.3.6, 7.2.6, 7.3.8, 9.10.4 and 9.10.5, shall, after decision or action by the Architect/Engineer or 30 days after submission of the Claim to the Architect/Engineer, be subject to arbitration provided a demand for arbitration is made within the time frame provided in Subparagraph 4.4.5. If such demand is not made with the specified time frame, the Architect/Engineer's decision or action is final. Prior to arbitration, the parties shall endeavor to resolve disputes by mediation in accordance with the provisions of Paragraph 4.5.
- 4.6.5. Claims not resolved by mediation shall be decided by arbitration which, unless the parties mutually agree otherwise, shall be in accordance with the Construction Industry Arbitration Rules of the American Arbitration Association currently in effect and/or those rules specified in the Contract Documents or separately agreed upon between the parties. Construction Industry Arbitration Rule R-3 (filing with AAA) is void. The parties shall mutually agree upon an arbitrator or arbitrators who shall then take the place of AAA in the Construction Industry Arbitration Rules. The parties must mutually agree to use AAA and no filing of a demand for arbitration shall be made to AAA by either party until such mutual agreement has been made. The demand for arbitration shall be filed in writing with the other party to the Contract and a copy shall be filed with the Architect/Engineer.
- 4.6.6. A demand for arbitration shall be made within the time limits specified in Subparagraphs 4.4.5 and in no event shall it be made after the date when institution of legal or equitable proceedings based on such Claim would be barred by the applicable statute of limitations as determined pursuant to Paragraph 13.7.
- 4.6.7. Pending final resolution of a Claim including arbitration, unless otherwise mutually agreed in writing, the Contractor shall proceed diligently with performance of the Contract and the Owner shall continue to make payments in accordance with the Contract on Work or amounts not in dispute.
- 4.6.8. **Limitation on Consolidation or Joinder.** Arbitration arising out of or relating to the Contract may include by consolidation or joinder the Architect/Engineer, the Architect/Engineer's employees or consultants,

except by written consent containing specific reference to the Agreement and signed by the Architect/Engineer, Owner, Contractor and any other person or entity sought to be joined. No arbitration shall include, by consolidation or joinder or in any other manner, parties other than the Owner, Architect/Engineer, Contractor, a separate contractor as described in Article 6 and other persons substantially involved in a common question of fact or law whose presence is required if complete relief is to be accorded in arbitration. No person or entity other than the Owner, Architect/Engineer, Contractor or a separate contractor as described in Article 6 shall be included as an original third party or additional third party to an arbitration whose interest or responsibility is insubstantial. The foregoing agreement to arbitrate and other agreements to arbitrate with an additional person or entity duly consented to by parties to the Agreement shall be specifically enforceable under applicable law in any court having jurisdiction thereof.

4.6.9. **Claims and Timely Assertion of Claims.** The party filing a demand for arbitration must assert in the demand all Claims then known to that party on which arbitration is permitted to be demanded.

4.6.10. **Judgment on Final Award.** The award rendered by the arbitrator or arbitrators shall be final, and judgment may be entered upon it in accordance with applicable law in any court having jurisdiction thereof. The parties agree that the costs of the arbitrator(s)' compensation and expenses shall be borne equally. The parties further agree that the arbitrator(s) shall have authority to award to either party some or all of the costs and expenses involved, including attorney's fees.

## **ARTICLE 5 – SUBCONTRACTORS**

### **5.1. DEFINITIONS**

5.1.1. A Subcontractor is a person or entity who has a direct or indirect contract at any tier or level with the Contractor or any Subcontractor to the Contractor to perform a portion of the Work at the site. The term "Subcontractor" is referred to throughout the Contract Documents as if singular in number and means a Subcontractor or an authorized representative of the Subcontractor. The term "Subcontractor" does not include a separate contractor or subcontractors of a separate contractor.

### **5.2. AWARD OF SUBCONTRACTS AND OTHER CONTRACTS FOR PORTIONS OF THE WORK**

5.2.1. Unless otherwise stated in the Contract Documents or the bidding requirements, the Contractor, as soon as practicable after award of the Contract and in no instance later than (30) days after award of the Contract, shall furnish in writing to the Owner through the Architect/Engineer the names of persons or entities (including those who are to furnish materials or equipment fabricated to a special design) proposed for each principal portion of the Work. The Architect/Engineer will promptly reply to the Contractor in writing stating whether or not the Owner or the Architect/Engineer, after due investigation, has reasonable objection to any such proposed person or entity.

5.2.2. The Contractor shall not contract with a proposed person or entity to which the Owner or Architect/Engineer has made reasonable and timely objection. The Contractor shall not be required to contract with anyone to whom the Contractor has made reasonable objection.

5.2.3. If the Owner or Architect/Engineer has reasonable objection to a person or entity proposed by the Contractor, the Contractor shall propose another to whom the Owner or Architect/Engineer has no reasonable objection. If the proposed but rejected Subcontractor was reasonably capable of performing the Work, the Contract Sum and Contract Time shall be increased or decreased by the difference, if any, occasioned by such change, and an appropriate Change Order shall be issued before commencement of the substitute Subcontractor's Work. However, no increase in the Contract Sum or Contract Time shall be allowed for such change unless the Contractor has acted promptly and responsively in submitting names as required.

5.2.4. The Contractor shall not change a Subcontractor, person or entity previously selected if the Owner or Architect/Engineer makes reasonable objection to such substitute. The Contractor shall not change or substitute for a Subcontractor who was required to be listed on the bid without first getting the approval of the Owner.

- 5.2.5. Buy-Safe Montana Provision: Before commencement of each subcontractor's portion of the Work, the Contractor shall obtain each subcontractor's incidence rate, experience modification rate, and loss ratio. The Contractor shall endeavor--but is not required--to use subcontractors whose incidence rate is less than the latest average for non-residential building construction for Montana as established by the Federal Bureau of Labor Statistics for the prior year; whose experience modification rating (EMR) is less than 1.0; and whose loss ratio is less than 100%. Contractor shall require any of its subcontractors who, based on the safety information that the Contractor obtains, have greater-than-average incidence rate, an EMR greater than 1.0, and a loss ratio of more than 100%, to schedule and obtain a Comprehensive Safety Consultation from the Montana Department of Labor & Industry, Employment Relations Division, Safety Bureau before substantial completion of each such subcontractor's portion of the Work. For assistance in obtaining the Comprehensive Safety Consultation, visit <http://erd.dli.mt.gov/safety-health/onsite-consultation>.

### **5.3. SUBCONTRACTUAL RELATIONS**

- 5.3.1. By appropriate agreement, written where legally required for validity, the Contractor shall require each Subcontractor, to the extent of the Work to be performed by the Subcontractor, to be bound to the Contractor by terms of the Contract Documents, and to assume toward the Contractor all the obligations and responsibilities, including the responsibility for safety of the Subcontractor's Work, which the Contractor, by these Documents, assumes toward the Owner and Architect/Engineer. Each subcontract agreement shall preserve and protect the rights of the Owner and Architect/Engineer under the Contract Documents with respect to the Work to be performed by the Subcontractor so that subcontracting thereof will not prejudice such rights, and shall allow to the Subcontractor, unless specifically provided otherwise in the subcontract agreement, the benefit of all rights, remedies and redress against the Contractor that the Contractor, by the Contract Documents, has against the Owner. Where appropriate, the Contractor shall require each Subcontractor to enter into similar agreements with Sub-subcontractors. The Contractor shall make available to each proposed Subcontractor, prior to the execution of the subcontract agreement, copies of the Contract Documents to which the Subcontractor will be bound, and, upon written request of the Subcontractor, identify to the Subcontractor terms and conditions of the proposed subcontract agreement which may be at variance with the Contract Documents. Subcontractors will similarly make copies of applicable portions of such documents available to their respective proposed Sub-subcontractors.
- 5.3.2. Upon written request by the Owner, the Contractor shall require its subcontractors to provide to it performance and payment securities for their portion of the Work in the types and form defined in statute (18-2-201 and 18-2-203 MCA) for all sub-contractual agreements.
- 5.3.3. The Contractor shall prepare a Subcontractors' and Suppliers' chart in CSI division format acceptable to the Owner which lists by name, all contact information, job category, and responsibility the Contractor's Subcontractors (at all tiers or levels) and Suppliers with a pecuniary interest in the Project of greater than \$5,000.00. The Contractor shall not enter into any agreement with any subcontractor or supplier to which the Owner raises a timely objection. The Contractor shall promptly inform the Owner in writing of any proposed replacements, the reasons therefore, and the name and qualifications of any proposed replacements. The Owner shall have the right to reject any proposed replacements without cost or claim being made by the Contractor. The chart shall be provided to the Owner at the time of the pre-construction conference but no less than 30 days after award of the Contract.
- 5.3.4. All Contractors and Subcontractors to this contract must comply with all Montana Department of Labor and Industry requirements, regulations, rules, and statutes.
- 5.3.5. In accordance with 39-51-1104 MCA, any Contractor who is or becomes an employer under the provisions of Title 39, Chapter 51 of Montana Code Annotated, who contracts with any Subcontractor who also is or becomes an employer under the provisions of Title 39, Chapter 51 of Montana Code Annotated, shall withhold sufficient money on the contract to guarantee that all taxes, penalties, and interest are paid upon completion of the contract.
- 5.3.5.1. It is the duty of any Subcontractor who is or becomes an employer under the provisions of Title 39, Chapter 51 of Montana Code Annotated, to furnish the Contractor with a certification issued by the Montana Department of Labor and Industry, prior to final payment stating that said

Subcontractor is current and in full compliance with the provisions of Montana Department of Labor and Industry.

5.3.5.2. Failure to comply shall render the Contractor directly liable for all taxes, penalties, and interest due from the Subcontractor, and the Montana Department of Labor and Industry has all of the remedies of collection against the Contractor under the provisions of Title 39, Chapter 51 of Montana Code Annotated, as though the services in question were performed directly for the Contractor.

5.3.6. In compliance with state statutes, the Contractor will have the 1% Gross Receipts Tax withheld from all payments. Each "Public Contractor" includes all Subcontractors with contracts greater than \$5,000 each. The Contractor and all Subcontractors will withhold said 1% from payments made to all Subcontractors with contracts greater than \$5,000.00 and make it payable to the Montana Department of Revenue. The Contractor and all Subcontractors shall also submit documentation of all contracts greater than \$5,000.00 to the Montana Department of Revenue on the Department's prescribed form.

**5.3.7.** Construction Contractor Registration: All Subcontractors at any tier or level are required to be registered with the Department of Labor and Industry under 39-9-201 and 39-9-204 MCA prior to the Contract being executed by the Owner. Subcontractors shall demonstrate to the Contractor that it has registered or promises that it will register immediately upon notice of award and prior to the commencement of any work.

#### **5.4. CONTINGENT ASSIGNMENT OF SUBCONTRACTS**

5.4.1. Each subcontract agreement for a portion of the Work is assigned by the Contractor to the Owner provided that:

5.4.1.1. assignment is effective only after termination of the Contract by the Owner for cause pursuant to Paragraph 14.2 and only for those subcontract agreements which the Owner accepts by notifying the Subcontractor and Contractor in writing; and,

5.4.1.2. assignment is subject to the prior rights of the surety, if any, obligated under bond relating to the Contract.

5.4.2. Upon such assignment, if the Work has been suspended for more than 30 days as a result of the Contractor's default, the Subcontractor's compensation shall be equitably adjusted for increases in cost resulting from the suspension. Such adjustment shall be at the expense of the Contractor.

5.4.3. The Contractor shall engage each of its subcontractors and suppliers with written contracts that preserve and protect the rights of the Owner and include the acknowledgement and agreement of each subcontractor and supplier that the Owner is a third-party beneficiary of their sub-contractual and supplier agreements. The Contractor's agreements shall require that in the event of default by the Contractor or termination of the Contractor, and upon request of the Owner, the Contractor's subcontractors and suppliers will perform services for the Owner.

5.4.4. Construction Contractor Registration: All Subcontractors at any tier or level are required to be registered with the Department of Labor and Industry under 39-9-201 and 39-9-204 MCA prior to the Contract being executed by the Owner. Subcontractors shall demonstrate to the Contractor that it has registered or promises that it will register immediately upon notice of award and prior to the commencement of any work.

### **ARTICLE 6 – CONSTRUCTION BY OWNER OR BY SEPARATE CONTRACTORS**

#### **6.1. OWNER'S RIGHT TO PERFORM CONSTRUCTION AND TO AWARD SEPARATE CONTRACTS**

6.1.1. The Owner reserves the right to perform construction or operations related to the Project with the Owner's own forces, and to award separate contracts in connection with other portions of the Project or other construction or operations on the site under Conditions of the Contract identical or substantially similar to these including those portions related to insurance and waiver of subrogation. If the Contractor claims

that delay or additional cost is involved because of such action by the Owner, the Contractor shall make such Claim as provided in Paragraph 4.3.

- 6.1.2. When separate contracts are awarded for different portions of the Project or other construction or operations on the site, the term "Contractor" in the Contract Documents in each case shall mean the Contractor who executes each separate Owner-Contractor Agreement.
- 6.1.3. The Owner shall provide for coordination of the activities of the Owner's own forces and of each separate contractor with the Work of the Contractor, who shall cooperate with them. The Contractor shall participate with other separate contractors and the Owner in reviewing their construction schedules when directed to do so. The Contractor shall make any revisions to the construction schedule deemed necessary after a joint review and mutual agreement. The construction schedules shall then constitute the schedules to be used by the Contractor, separate contractors and the Owner until subsequently revised.
- 6.1.4. Unless otherwise provided in the Contract Documents, when the Owner performs construction or operations related to the Project with the Owner's own forces, the Owner shall be deemed to be subject to the same obligations and to have the same rights which apply to the Contractor under the Conditions of the Contract, including, without excluding others, those stated in Article 3, this Article 6 and Articles 10, 11 and 12.

## **6.2. MUTUAL RESPONSIBILITY**

- 6.2.1. The Contractor shall afford the Owner and separate contractors reasonable opportunity' for introduction and storage of their materials and equipment and performance of their activities, and shall connect and coordinate the Contractor's construction and operations with theirs as required by the Contract Documents.
- 6.2.2. If part of the Contractor's Work depends for proper execution or results upon construction or operations by the Owner or a separate contractor, the Contractor shall, prior to proceeding with that portion of the Work, promptly report to the Architect/Engineer apparent discrepancies or defects in such other construction that would render it unsuitable for such proper execution and results. Failure of the Contractor so to report shall constitute an acknowledgment that the Owner's or separate contractor's completed or partially completed construction is fit and proper to receive the Contractor's Work, except as to defects not then reasonably discoverable.
- 6.2.3. The Owner shall be reimbursed by the Contractor for costs incurred by the Owner which are payable to a separate contractor because of delays, improperly timed activities or defective construction of the Contractor. The Owner shall be responsible to the Contractor for costs incurred by the Contractor because of delays, improperly timed activities, damage to the Work or defective construction of a separate contractor.
- 6.2.4. The Contractor shall promptly remedy damage wrongfully caused by the Contractor to completed or partially completed construction or to property of the Owner or separate contractors as provided in Paragraph 12.2.
- 6.2.5. The Owner and each separate contractor shall have the same responsibilities for cutting and patching as are described for the Contractor in Subparagraph 3.14.

## **6.3. OWNER'S RIGHT TO CLEAN UP**

- 6.3.1. If a dispute arises among the Contractor, separate contractors and the Owner as to the responsibility under their respective contracts for maintaining the premises and surrounding area free from waste materials and rubbish, the Owner may clean up and the Architect/Engineer will determine the responsibility of those involved and allocate the cost accordingly.



## **ARTICLE 7 – CHANGES IN THE WORK**

### **7.1. GENERAL**

- 7.1.1. Changes in the Work may be accomplished after execution of the Contract, and without invalidating the Contract, by Change Order, Construction Change Directive, or order for a minor change in the Work subject to the limitations stated in this Article 7 and elsewhere in the Contract Documents. Minor changes as ordered by the Architect/Engineer has the definition provided in Paragraph 7.4
- 7.1.2. A Change Order shall be based upon agreement among the Owner, Contractor, and Architect/Engineer; a Construction Change Directive requires agreement by the Owner and Architect/Engineer and may or may not be agreed to by the Contractor; an order for a minor change in the Work may be issued by the Architect/Engineer alone.
- 7.1.3. Changes in the Work shall be performed under applicable provisions of the Contract Documents and the Contractor shall proceed promptly, unless otherwise provided in the Change Order, Construction Change Directive, or order for a minor change in the Work.
- 7.1.4. No act, omission, or course of dealing, shall alter the requirement that Change Orders or Construction Change Directives shall be in writing and signed by the Owner, and that Change Orders and Construction Change Directives are the exclusive method for effecting any adjustment to the Contract. The Contractor understands and agrees that neither the Contract Sum nor the Contract Time can be changed by implication, oral agreement, verbal directive, or unsigned Change Order.

### **7.2. CHANGE ORDERS**

- 7.2.1. A Change Order is a written instrument prepared by the Architect/Engineer and signed by the Owner, Contractor and Architect/Engineer, stating their agreement upon all of the following:
  - 7.2.1.1. change in the Work;
  - 7.2.1.2. the amount of the adjustment, if any, in the Contract Sum; and,
  - 7.2.1.3. the extent of the adjustment, if any, in the Contract Time.
- 7.2.2. The cost or credit to the Owner resulting from a change in the Work shall be determined as follows:
  - 7.2.2.1. Per the limitations of this Subparagraph, plus a 5% allowance for overhead and a 10% allowance for profit. The allowances for overhead and for profit are limited to the percentages as specified herein unless they are determined to be unreasonable by the Architect/Engineer (not the Contractor) per Subparagraph 7.3.9 for each Change Order or Construction Change Directive; or,
  - 7.2.2.2. By one of the methods in Subparagraph 7.3.4, or as determined by the Architect/Engineer per Subparagraph 7.3.9, plus a 5% allowance for overhead and a 10% allowance for profit. The allowances for overhead and for profit are limited to the percentages as specified herein unless they are determined to be unreasonable by the Architect/Engineer (not the Contractor) per Subparagraph 7.3.9 for each Change Order or Construction Change Directive.
  - 7.2.2.3. The Contractor's proposed increase or decrease in cost shall be limited to costs listed in Subparagraph 7.3.9.1 through 7.3.9.5.
- 7.2.3. The Contractor shall not submit any Change Order, response to requested cost proposals, or requested changes which are incomplete and do not contain full breakdown and supporting documentation in the following three areas:
  - 7.2.3.1. Direct costs (only those listed in Subparagraph 7.3.9.1 through 7.3.9.5 are allowable);
  - 7.2.3.2. Indirect costs (limited as a percentage on each Change Order per Supplementary General Conditions, Paragraph 7.2.2); and

- 7.2.3.3. Consequential items (e.g. time extensions, credits, logic, reasonableness, impacts, disruptions, dilution).
- 7.2.4. Any Change Order, responses to requested proposals, or requested changes submitted by the Contractor which, in the opinion of the Architect/Engineer, are incomplete, may be rejected and returned to the Contractor without comment. It is the responsibility of and incumbent upon the Contractor to ensure and confirm that all Change Orders, responses to requested proposals, or requested changes are complete prior to submission.
- 7.2.5. Overhead, applicable to all areas and sections of the Contract Documents, means "Indirect Costs" as referenced in Subparagraph 7.2.3.2. Indirect costs are inclusive of, but not limited to, the following: home office overhead; off-site supervision; home office project management; change order and/or proposal preparation, design, research, negotiation and associated travel; effects of disruption and dilution of management and supervision off-site; time delays; coordination of trades; postage and shipping; and, effective increase in guarantee and warranty durations. Indirect costs applicable to any and all changes in the work, either through Change Order or Construction Change Directive, are limited to the percentage allowance for overhead in Subparagraph 7.2.2.
- 7.2.6. By signature on any Change Order, the Contractor certifies that the signed Change Order is complete and includes all direct costs, indirect costs and consequential items (including additional time, if any) and is free and clear of all claims or disputes (including, but not limited to, claims for additional costs, additional time, disruptions, and/or impacts) in favor of the Contractor, subcontractors, material suppliers, or other persons or entities concerning the signed change order and on all previously contracted Work and does release the Owner from such claims or demands.
- 7.2.7. Any and all changes or adjustments to the Contract Time requested or claimed by the Contractor as a result of a Change Order shall require documentation and justification for the adjustment by a Critical Path Method analysis of the Contractor's most recent Critical Path Schedule in use prior to the change. Changes which affect or concern activities containing float or slack time (i.e. not on the critical path) and which can be accomplished within such float or slack time, shall not result in an increase in the Contract Time.
- 7.2.8. Supervision means on-site, field supervision and not home office overhead, off-site management or off-site supervision.
- 7.2.9. Labor means those persons engaged in construction occupations as defined in Montana Prevailing Wage Rates for Building Construction or Heavy/Highway as bound in the Contract Documents and does not include design, engineering, superintendence, management, on-site field supervision, home office or other off-site management, off-site supervision, office or clerical work.

### **7.3. CONSTRUCTION CHANGE DIRECTIVES**

- 7.3.1. A Construction Change Directive is a written order prepared by the Architect/Engineer directing a change in the Work prior to agreement on adjustment, if any, in the Contract Sum or Contract Time, or both. The Owner may by Construction Change Directive, without invalidating the Contract, order changes in the Work within the general scope of the Contract consisting of additions, deletions or other revisions, the Contract Sum and Contract Time being adjusted accordingly.
- 7.3.2. Any and all changes or adjustments to the Contract Time requested or claimed by the Contractor as a result of a Construction Change Directive, shall require documentation and justification for the adjustment by a Critical Path Method analysis of the Contractor's most recent Critical Path Schedule in use prior to the change. Changes that affect or concern activities containing float or slack time (i.e. not on the critical path) and which can be accomplished within such float or slack time shall not result in an increase in the Contract Time.
- 7.3.3. A Construction Change Directive shall be used in the absence of agreement on the terms of a Change Order.

- 7.3.4. If the Construction Change Directive provides for an adjustment to the Contract Sum, the adjustment shall be based on one of the following methods:
  - 7.3.4.1. mutual acceptance of a lump sum properly itemized and supported by sufficient substantiating data to permit evaluation;
  - 7.3.4.2. unit prices stated in the Contract Documents or subsequently agreed upon;
  - 7.3.4.3. cost to be determined in a manner agreed upon by the parties and a mutually acceptable fixed or percentage fee;
  - 7.3.4.4. By actual cost as shown by the Contractor's and Subcontractor's itemized invoices; or
  - 7.3.4.5. as provided in Subparagraph 7.3.9.
- 7.3.5. Costs shall be limited to the following: cost of materials, including cost of delivery; cost of labor, including social security, old age and unemployment insurance and fringe benefits under collective bargaining agreements; workers' compensation insurance; bond premiums; and rental value of power tools and equipment.
- 7.3.6. Overhead and profit allowances shall be limited on all Construction Change Directives to those identified in 7.2.2.
- 7.3.7. Upon receipt of a Construction Change Directive, the Contractor shall promptly proceed with the change in the Work involved and advise the Architect/Engineer of the Contractor's agreement or disagreement with the method, if any, provided in the Construction Change Directive for determining the proposed adjustment in the Contract Sum or Contract Time.
- 7.3.8. A Construction Change Directive signed by the Contractor indicates the agreement of the Contractor therewith, including adjustment in Contract Sum and Contract Time or the method for determining them. Such agreement shall be effective immediately and shall be recorded as a Change Order.
- 7.3.9. If the Contractor does not respond or disagrees with the method for adjustment in the Contract Sum in writing within seven (7) calendar days, the method and the adjustment made shall be determined by the Architect/Engineer on the basis of reasonable expenditures and/or savings of those performing the Work directly attributable to the change including, in the case of an increase in the Contract Sum, plus an allowance for overhead and profit as listed under Subparagraph 7.2.2. In such case, and also under Clause 7.3.4.3, the Contractor shall keep and present, in such form as the Architect/Engineer may prescribe, an itemized accounting together with appropriate supporting data. Unless otherwise provided in the Contract Documents, costs for the purposes of this Subparagraph 7.3.9 shall be limited to the following:
  - 7.3.9.1. costs of labor, including social security, old age and unemployment insurance, fringe benefits required by agreement or custom, and workers' compensation insurance as determined by the Prevailing Wage Schedules referenced in the Contract Documents;
  - 7.3.9.2. costs of materials, supplies and equipment, including cost of transportation, whether incorporated or consumed;
  - 7.3.9.3. rental costs of machinery and equipment, exclusive of hand tools, whether rented from the Contractor or others;
  - 7.3.9.4. costs of premiums for all bonds and insurance, permit fees, and sales, use or similar taxes related to the Work; and
  - 7.3.9.5. additional costs of field supervision and field office personnel directly attributable to the change.
- 7.3.10. The amount of credit to be allowed by the Contractor to the Owner for a deletion or change which results in a net decrease in the Contract Sum shall be actual net cost as confirmed by the Architect/Engineer. When both additions and credits covering related Work or substitutions are involved in a change, the

allowance for overhead and profit shall be figured on the basis of net increase, if any, with respect to that change.

- 7.3.11. Pending final determination of the total cost of a Construction Change Directive to the Owner, amounts not in dispute for such changes in the Work shall be included in Applications for Payment accompanied by a Change Order indicating the parties' agreement with part or all of such costs. For any portion of such cost that remains in dispute, the Architect/Engineer will make an interim determination for purposes of monthly certification for payment for those costs. That determination of cost shall adjust the Contract Sum on the same basis as a Change Order, subject to the right of either party to disagree and assert a claim in accordance with Article 4.
- 7.3.12. When the Owner and Contractor agree with the determination made by the Architect/Engineer concerning the adjustments in the Contract Sum and Contract Time, or otherwise reach agreement upon the adjustments, such agreement shall be effective immediately and shall be recorded by preparation and execution of an appropriate Change Order.

#### **7.4. MINOR CHANGES IN THE WORK**

- 7.4.1. The Architect/Engineer will have authority to order minor changes in the Work not involving adjustment in the Contract Sum or extension of the Contract Time and not inconsistent with the intent of the Contract Documents. Such changes shall be effected by written order and shall be binding on the Owner and Contractor. The Contractor shall carry out such written orders promptly.

### **ARTICLE 8 – TIME**

#### **8.1. DEFINITIONS**

- 8.1.1. Time is of the essence in performance, coordination, and completion of the Work contemplated herein. The Owner may suffer damages if the Work is not completed as specified herein. When any duration or time period is referred to in the Contract Documents by days, the first day shall be determined as the day following the current day of any event or notice starting a specified duration.
- 8.1.2. Unless otherwise provided, Contract Time is the period of time, including authorized adjustments, allotted in the Contract Documents for Substantial Completion of the Work.
- 8.1.3. The date of commencement of the Work is the date established in the NOTICE TO PROCEED AS ISSUED BY THE OWNER.
- 8.1.4. The date the Contractor reaches Substantial Completion is the date certified by the Architect/Engineer in accordance with Paragraph 9.8.
- 8.1.5. The term "day" as used in the Contract Documents shall mean calendar day unless otherwise specifically defined.
- 8.1.6. Liquidated Damages. The Owner may suffer loss if the project is not substantially complete on the date set forth in the contract documents. The Contractor and his surety shall be liable for and shall pay to the Owner the sums hereinafter stipulated as liquidated damages for each calendar day of delay until the work is substantially complete: **See Instructions to Bidders.**
- 8.1.7. The Contractor shall not be charged liquidated or actual damages when delay in completion of the Work is due to:
  - 8.1.7.1. Any preference, priority or allocation order issued by the government;
  - 8.1.7.2. Unforeseeable cause beyond the control and without the fault or negligence of the Contractor, such as acts of God or of the public enemy, fires, floods, epidemics, quarantine restrictions, freight embargoes, and unusually severe weather. All such occurrences resulting in delay must be documented and approved by Change Order; or,

8.1.7.3. Any delays of Subcontractors or suppliers occasioned by any of the causes specified in 8.1.7.1 and 8.1.7.2 of this article.

8.1.8. The Contractor is completely obligated and responsible to provide written notice of each day of delay as provided for in Paragraph 4.3.

8.1.9. Contract Time. All work shall reach Substantial Completion by: **See Instructions to Bidders.** The Owner will issue a written NOTICE TO PROCEED and finalized contract.

## **8.2. PROGRESS AND COMPLETION**

8.2.1. Time limits stated in the Contract Documents are of the essence of the Contract. By executing the Contract, the Contractor confirms that the Contract Time is a reasonable period for performing the Work.

8.2.2. The Contractor shall not knowingly, except by agreement or instruction of the Owner in writing, prematurely commence operations on the site or elsewhere prior to the date on the Notice to Proceed and in no case prior to the effective date of insurance required by Article 11 to be furnished by the Contractor. The date of commencement of the Work shall not be changed by the effective date of such insurance.

8.2.3. The Contractor shall proceed expeditiously with adequate forces and shall achieve Substantial Completion within the Contract Time.

8.2.4. If the Contractor falls behind the latest construction schedule by more than 14 calendar days through its own actions or inaction, neglect, inexperience, lack of oversight and management of the Work including that of any Subcontractors, written notice to the Owner and Architect/Engineer shall be provided within three (3) days with explanation of how the Contractor intends to get back on schedule. Response to getting back on schedule consists of providing a sufficient number of qualified workers and/or proper materials or an acceptably reorganized schedule to regain the lost time in a manner acceptable to the Owner.

## **8.3. DELAYS AND EXTENSIONS OF TIME**

8.3.1. If the Contractor is delayed at any time in the commencement or progress of the Work by an act or neglect of the Owner or Architect/Engineer, or of an employee of either, or of a separate contractor employed by the Owner, or by changes ordered in the Work, or by fire, unusual delay in deliveries, unavoidable casualties or other causes beyond the Contractor's control, or by delay authorized by the Owner pending mediation and arbitration, or by other causes which the Architect/Engineer determines may justify delay, then the Contract Time shall be extended by Change Order for such reasonable time as the Architect/Engineer may determine.

8.3.2. Claims relating to time shall be made in accordance with applicable provisions of Paragraph 4.3.

8.3.3. This Paragraph 8.3 does not preclude recovery of damages for delay by either party under other provisions of the Contract Documents.

## **PAYMENTS AND COMPLETION**

### **9.1. CONTRACT SUM**

9.1.1. The Contract Sum is stated in the Contract and, including authorized adjustments, is the total amount payable by the Owner to the Contractor for performance of the Work under the Contract Documents.

### **9.2. SCHEDULE OF VALUES**

9.2.1. Before the first Application for Payment, the Contractor shall submit to the Architect/Engineer a schedule of values allocated to various portions of the Work, prepared in such form and supported by such data to substantiate its accuracy as the Architect/Engineer may require. This schedule, unless objected to by the Architect/Engineer, shall be used as a basis for reviewing the Contractor's Applications for Payment.

### **9.3. APPLICATIONS FOR PAYMENT**

- 9.3.1. The Contractor shall submit to the Architect/Engineer an itemized Application for Payment for operations completed in accordance with the Schedule of Values. Such application shall be signed and supported by such data substantiating the Contractor's right to payment as the Owner or Architect/Engineer may require, such as copies of requisitions from Subcontractors and material suppliers, and reflecting retainage if provided for in the Contract Documents.
- 9.3.2. NOTICE OF APPROVAL OF PAYMENT REQUEST PROVISION. Per Title 28, Chapter 2, Part 21, this contract allows the Owner to change the number of days to approve a Contractor's payment request. This contract allows the Owner to approve the Contractor's payment request within thirty-five (35) calendar days after it is received by the Owner without being subject to the accrual of interest.
- 9.3.3. As provided in Subparagraph 7.3.11, such applications may include requests for payment on account of changes in the Work which have been properly authorized by Construction Change Directives, or by interim determinations of the Architect/Engineer, but not yet included in Change Orders.
- 9.3.4. Applications for payment shall not include requests for payment for portions of the Work for which the Contractor does not intend to pay to a Subcontractor or material supplier.
- 9.3.5. Unless otherwise provided in the Contract Documents, payments shall be made on account of materials and equipment delivered and suitably stored at the site for subsequent incorporation in the Work. If approved in advance by the Owner, payment may similarly be made for materials and equipment suitably stored off the site at a location agreed upon in writing. Payment for materials and equipment stored on or off the site shall be conditioned upon compliance by the Contractor with procedures satisfactory to the Owner to establish the Owner's title to such materials and equipment or otherwise protect the Owner's interest, and shall include the costs of applicable insurance, storage and transportation to the site for such materials and equipment stored off the site.
- 9.3.6. The Contractor warrants that title to all Work covered by an Application for Payment will pass to the Owner no later than the time of payment. The Contractor further warrants that upon submittal of an Application for Payment all Work for which Certificates for Payment have been previously issued and payments received from the Owner shall, to the best of the Contractor's knowledge, information and belief, be free and clear of liens, claims, security interests or encumbrances in favor of the Contractor, Subcontractors, material suppliers, or other persons or entities making a claim by reason of having provided labor, materials and equipment relating to the Work.
- 9.3.7. Until the work is complete, the Owner will pay 95% of the amount due the Contractor on account of progress payments.
  - 9.3.7.1. If the Work and its progress are not in accordance with all or any part, piece, or portion of the Contract Documents, the Owner may, at its sole discretion and without claim by the Contractor, increase the amount held as retainage to whatever level deemed necessary to effectuate performance and progress of the Work, for anticipated repairs, warranties or completion of the Work by the Contractor or through the letting of other contracts. The Contractor will not be entitled to additional costs, expenses, fees, time, and such like, in the event the Owner increases the amount held as retainage due to non-compliance and/or non-performance with all or any part, piece, or portion of the Contract Documents.
  - 9.3.7.2. Prior to the first application for payment, the Contractor shall submit the following information on the appropriate forms:
    - 9.3.7.2.1. Schedule of Amounts for Contract Payment (Form 100): This form shall contain a breakdown of the labor, material and other costs associated with the various portions of the work and shall be the basis for the progress payments to the Contractor. The use of electronic method shall be in the Owner's format.
    - 9.3.7.2.2. Project/Progress Schedule: If no Schedule (or revised Schedule) is provided with each and every Periodic Estimates for Partial Payment, the Architect/Engineer and/or Owner may return the pay request, or hold it, and may choose not pay for

any portion of the Work until the appropriate Schedule, indicating all changes, revisions and updates, is provided. No claim for additional costs or interests will be made by the Contractor or any subcontractor on account of holding or non-payment of the Periodic Estimate for Partial Payment request.

#### 9.3.7.3. Progress Payments

9.3.7.3.1. Periodic Estimates for Partial Payment shall be on a form provided by the Owner (Form 101) and submitted to the Architect/Engineer for payment by the Owner. Payment shall be requested for the labor and material incorporated in the work to date and for materials suitably stored, less the aggregate of previous payments, the retainage, and the 1% gross receipts tax.

9.3.7.3.2. The Contractor, by submission of any partial pay request, certifies that every request for partial payment is correct, true and just in all respects and that payment or credit had not previously been received. The Contractor further warrants and certifies, by submission of any partial pay request, that all previous work for which payment has been received is free and clear of all liens, disputes, claims, security interests, encumbrances, or causes of action of any type or kind in favor of the Contractor, subcontractors, material suppliers or other persons or entities and does release the Owner from such.

9.3.7.3.3. Progress payments do not constitute official acceptance of any portion of the work or materials whether stored on or off-site.

9.3.7.3.4. In compliance with 15-50-206 MCA, the Contractor will have 1% of his gross receipts withheld by the Owner from all payments due. Each subcontractor who performs work greater than \$5,000 shall have 1% of its gross receipts withheld by the Contractor. The Contractor shall notify the Department of Revenue on the department's prescribed forms.

9.3.7.4. The Contractor may submit obligations/securities in a form specified in 18-1-301 Montana Code Annotated (MCA) to be held by a Financial Institution in lieu of retainage by the Owner. The Owner will establish the amount that would otherwise be held as retainage. Should the Contractor choose to submit obligations/securities in lieu of retainage, the Owner will require the Financial Institution to execute the Owner's "Account Agreement for Deposit of Obligations Other Than Retainage" (Form 120) prior to submission of any obligations/securities in accordance with 18-1-302 MCA. The Contractor must extend the opportunity to participate in all obligations/securities in lieu of retainage on a pro rata basis to all subcontractors involved in the project and shall be solely responsible for the management and administration of same. The Owner assumes no liability or responsibility from or to the Contractor or Subcontractors regarding the latter's participation.

**9.3.7.5.** The Contractor shall maintain a monthly billing cycle.

#### **9.4. CERTIFICATES FOR PAYMENT**

9.4.1. The Architect/Engineer will, within seven days after receipt of the Contractor's Application for Payment, either issue to the Owner a Certificate for Payment, with a copy to the Contractor, for such amount as the Architect/Engineer determines is properly due, or notify the Contractor and Owner in writing of the Architect/Engineer's reasons for withholding certification in whole or in part as provided in Subparagraph 9.5.1. For the purposes of this paragraph regarding certification of payment, electronic mail and/or notes provided through the use of an electronic approval system shall constitute written notice.

9.4.2. The issuance of a Certificate for Payment will constitute a representation by the Architect/Engineer to the Owner, based on the Architect/Engineer's evaluation of the Work and the data comprising the Application for Payment, that the Work has progressed to the point indicated and that, to the best of the Architect/Engineer's knowledge, information and belief, the quality of the Work is in accordance with the Contract Documents. The foregoing representations are subject to an evaluation of the Work for conformance with the Contract Documents upon Substantial Completion, to results of subsequent tests and inspections, to correction of minor deviations from the Contract Documents prior to completion and to specific qualifications expressed by the Architect/Engineer. The issuance of a Certificate for Payment will further constitute a representation that the Contractor is entitled to payment in the amount certified.

However, the issuance of a Certificate for Payment will not be a representation that the Architect/Engineer has: (1) made exhaustive or continuous on-site inspections to check the quality or quantity of the Work; (2) reviewed construction means, methods, techniques, sequences or procedures; (3) reviewed copies of requisitions received from Subcontractors and material suppliers and other data requested by the Owner to substantiate the Contractor's right to payment; or, (4) made examination to ascertain how or for what purpose the Contractor has used money previously paid on account of the Contract Sum.

## **9.5. DECISIONS TO WITHHOLD CERTIFICATION**

9.5.1. The Architect/Engineer may withhold or reject a Certificate for Payment in whole or in part, to the extent reasonably necessary to protect the Owner, if in the Architect/Engineer's opinion the representations to the Owner required by Subparagraph 9.4.2 cannot be made. If the Architect/Engineer is unable to certify payment in the amount of the Application, the Architect/Engineer will notify the Contractor and Owner as provided in Subparagraph 9.4.1. If the Contractor and Architect/Engineer cannot agree on a revised amount, the Architect/Engineer will promptly issue a Certificate for Payment for the amount for which the Architect/Engineer is able to make such representations to the Owner. The Architect/Engineer may also withhold a Certificate for Payment or, because of subsequently discovered evidence, may nullify the whole or a part of a Certificate for Payment previously issued, to such extent as may be necessary in the Architect/Engineer's opinion to protect the Owner from loss for which the Contractor is responsible, including loss resulting from acts and omissions described in Subparagraph 3.3.4, because of:

9.5.1.1. defective Work not remedied;

9.5.1.2. third party claims filed or reasonable evidence indicating probable filing of such claims unless security acceptable to the Owner is provided by the Contractor;

9.5.1.3. failure of the Contractor to make payments properly to Subcontractors or for labor, materials or equipment;

9.5.1.4. reasonable evidence that the Work cannot be completed for the unpaid balance of the Contract Sum;

9.5.1.5. damage to the Owner or another contractor;

9.5.1.6. reasonable evidence that the Work will not be completed within the Contract Time, and that the unpaid balance would not be adequate to cover actual or liquidated damages for the anticipated delay; or,

9.5.1.7. persistent failure to carry out the Work in accordance with the Contract Documents.

9.5.2. When the above reasons for withholding certification are removed, certification will be made for amounts previously withheld.

9.5.3. Owner's Right to Refuse Payment: The Architect/Engineer's approval, or partial approval, of the Contractor's request for payment shall not preclude or prevent the Owner from exercising any of its remedies under this Contract. The Owner shall have right to refuse to make payment(s) to the Contractor due to:

9.5.3.1. the Contractor's failure to perform the Work in compliance with the Contract Documents;

9.5.3.2. the Contractor's failure to correct any defective or damaged Work;

9.5.3.3. the Contractor's failure to accurately represent the Work performed in the pay request;

9.5.3.4. the Contractor's performance of its Work at a rate or in a manner that, in the Owner's opinion, is likely to result in the Work, or any portion thereof, to be delayed;

9.5.3.5. the Contractor's failure to use funds previously paid to it by the Owner to pay for the Contractor's Work-related obligations including, but not limited to, subcontractors and suppliers on this Project;



- 9.5.3.6. claims made, or anticipated by the Owner to be made, against the Owner or its property;
- 9.5.3.7. inclusion in the pay request of any amounts in dispute or part of a claim;
- 9.5.3.8. Damage or loss caused by the Contractor, including its subcontractors and suppliers; or,
- 9.5.3.9. The Contractor's failure or refusal to perform its obligations to the Owner.

## **9.6. PROGRESS PAYMENTS**

- 9.6.1. After the Architect/Engineer has issued a Certificate for Payment, the Owner shall make payment in the manner and within the time provided in the Contract Documents or the Owner may take any action the Owner deems necessary under Subparagraph 9.5.3.
- 9.6.2. The Contractor shall promptly pay each Subcontractor in accordance with Title 28, Chapter 2, Part 21, upon receipt of payment from the Owner, out of the amount paid to the Contractor on account of such Subcontractor's portion of the Work, the amount to which said Subcontractor is entitled, reflecting percentages actually retained from payments to the Contractor on account of such Subcontractor's portion of the Work. The Contractor shall, by appropriate agreement with each Subcontractor, require each Subcontractor to make payments to Sub-subcontractors in a similar manner.
- 9.6.3. The Contractor is prohibited from holding higher amounts in retainage on any Subcontractor than the Owner is holding from the Contractor.
- 9.6.4. The Architect/Engineer will, on request, furnish to a Subcontractor, if practicable, information regarding percentages of completion or amounts applied for by the Contractor and action taken thereon by the Architect/Engineer and Owner on account of portions of the Work done by such Subcontractor.
- 9.6.5. Neither the Owner nor Architect/Engineer shall have an obligation to pay, or to see to the payment of, money to a Subcontractor except as may otherwise be required by law.
- 9.6.6. Payment to material suppliers shall be treated in a manner similar to that provided in Subparagraphs 9.6.2, 9.6.3, 9.6.4, and 9.6.5.
- 9.6.7. A Certificate for Payment, a progress payment, or partial or entire use or occupancy of the Project by the Owner shall not constitute acceptance of Work not in accordance with the Contract Documents.
- 9.6.8. Unless the Contractor provides the Owner with a payment bond in the full penal sum of the Contract Sum, payments received by the Contractor for Work properly performed by Subcontractors and suppliers shall be held by the Contractor for those Subcontractors or suppliers who performed Work or furnished materials, or both, under contract with the Contractor for which payment was made by the Owner. Nothing contained herein shall require money to be placed in a separate account and not commingled with money of the Contractor, shall create any fiduciary liability or tort liability on the part of the Contractor for breach of trust or shall entitle any person or entity to an award of punitive damages against the Contractor for breach of the requirements of this provision.

## **9.7. FAILURE OF PAYMENT**

- 9.7.1. If the Owner does not approve payment to the Contractor within thirty-five (35) calendar days after the receipt of a certified Application for Payment, then the Contractor may, upon seven additional days' written notice to the Owner and Architect/Engineer, suspend the Work until payment of the amount owing has been received. Nothing in the Subparagraph shall limit the Owner's rights and options as provided in Subparagraph 9.5.3. The Contract Time shall be extended appropriately and the Contract Sum shall be increased by the amount of the Contractor's reasonable costs of shut-down, delay and start-up, plus interest as provided for in the Contract Documents.

## **9.8. SUBSTANTIAL COMPLETION**

- 9.8.1. Substantial Completion is the stage in the progress of the Work when the Work or designated portion thereof is sufficiently complete in accordance with the Contract Documents so that the Owner can occupy or utilize the Work for its intended use.
- 9.8.2. When the Contractor considers that the Work, or a portion thereof which the Owner agrees to accept separately, is substantially complete, the Contractor shall prepare and submit to the Architect/Engineer a comprehensive list of items to be completed or corrected prior to final payment. Failure to include an item on such list does not alter the responsibility of the Contractor to complete all Work in accordance with the Contract Documents.
- 9.8.3. Upon receipt of the Contractor's list, the Architect/Engineer will make an inspection to determine whether the Work or designated portion thereof is substantially complete. If the Architect/Engineer's Inspection discloses any item, whether or not included on the Contractor's list, which is not sufficiently complete in accordance with the Contract Documents so that the Owner can occupy or utilize the Work or designated portion thereof for its intended use, the Contractor shall, before issuance of the Certificate of Substantial Completion, complete or correct such item upon notification by the Architect/Engineer. In such case, the Contractor shall then submit a request for another inspection by the Architect/Engineer to determine Substantial Completion.
- 9.8.4. The Contractor shall ensure the project is substantially complete prior to requesting any inspection by the Architect/Engineer so that no more than one (1) inspection is necessary to determine Substantial Completion for all or any portion of the Work. If the Contractor does not perform adequate inspections to develop a comprehensive list as required in Subparagraph 9.8.2 and does not complete or correct such items upon discovery or notification, the Contractor shall be responsible and pay for the costs of the Architect/Engineer's additional inspections to determine Substantial Completion.
- 9.8.5. When the Work or designated portion thereof is substantially complete, the Architect/Engineer will prepare a Certificate of Substantial Completion which shall establish the date of Substantial Completion and which shall establish responsibilities of the Owner and Contractor for security, maintenance, heat, utilities, damage to the Work and insurance. After issuance of the Certificate of Substantial Completion, the Contractor shall finish and complete all remaining items within thirty (30) calendar days of the date on the Certificate. The Architect/Engineer shall identify and fix the time for completion of specific items which may be excluded from the thirty (30) calendar day time limit. Failure to complete any items within the specified time frames may be deemed by the Owner as default of the contract on the part of the Contractor.
- 9.8.6. The Certificate of Substantial Completion shall be submitted to the Owner and Contractor for their written acceptance of responsibilities assigned to them in such Certificate. Upon such acceptance and consent of surety if there are claims or past payment issues, the Owner shall make payment of retainage applying to such Work or designated portion thereof. Such payment shall be adjusted for Work that is incomplete or not in accordance with the requirements of the Contract Documents.

## **9.9. PARTIAL OCCUPANCY OR USE**

- 9.9.1. The Owner may occupy or use any completed or partially completed portion of the Work at any stage when such portion is designated by separate agreement with the Contractor, provided such occupancy or use is consented to by the insurer and authorized by public authorities having jurisdiction over the Work. Such partial occupancy or use may commence whether or not the portion is substantially complete, provided the Owner and Contractor have accepted in writing the responsibilities assigned to each of them for payments, retainage, if any, security, maintenance, heat, utilities, damage to the Work and insurance, and have agreed in writing concerning the period for correction of the Work and commencement of warranties required by the Contract Documents. When the Contractor considers a portion substantially complete, the Contractor shall prepare and submit a list to the Architect/Engineer as provided under Subparagraph 9.8.2. Consent of the Contractor to partial occupancy or use shall not be unreasonably withheld. The stage of the progress of the Work shall be determined by written agreement between the Owner and Contractor or, if no agreement is reached, by decision of the Architect/Engineer.

- 9.9.2. Immediately prior to such partial occupancy or use, the Owner, Contractor and Architect/Engineer shall jointly inspect the area to be occupied or portion of the Work to be used in order to determine and record the condition of the Work. Unless otherwise agreed upon, partial occupancy or use of a portion or portions of the Work shall not constitute acceptance of Work not complying with the requirements of the Contract Documents.
- 9.9.3. Unless otherwise agreed upon, partial occupancy or use of a portion or portions of the Work shall not constitute acceptance of Work not complying with the requirements of the Contract Documents.

#### **9.10. FINAL COMPLETION AND FINAL PAYMENT**

- 9.10.1. Upon receipt of written notice that the Work is ready for final inspection and acceptance and upon receipt of a final Application for Payment, the Architect/Engineer will promptly make such inspection and, when the Architect/Engineer finds the Work acceptable under the Contract Documents and the Contract fully performed, the Architect/Engineer will approve the Contractor's final Certificate for Payment stating that to the best of the Architect/Engineer's knowledge, information and belief, and on the basis of the Architect/Engineer's on-site visits and inspections, the Work has been completed in accordance with terms and conditions of the Contract Documents and that the entire balance found to be due the Contractor and noted in the final Certificate is due and payable. The Architect/Engineer's signature on the Contractor's final Certificate for Payment will constitute a further representation that conditions listed in Subparagraph 9.10.2 as precedent to the Contractor's being entitled to final payment have been fulfilled.
- 9.10.2. Neither final payment nor any remaining retainage shall become due until the Contractor submits to the Architect/Engineer:
  - 9.10.2.1. completed Contractor's Affidavit of Completion, Payment of Debts and Claims, and Release of Liens (Form 106) that payrolls, bills for materials and equipment, and other indebtedness connected with the Work for which the Owner or the Owner's property might be responsible or encumbered (less amounts withheld by Owner) have been paid or otherwise satisfied;
  - 9.10.2.2. a certificate evidencing that insurance required by the Contract Documents to remain in force after final payment is currently in effect and will not be canceled or allowed to expire until at least 30 days' prior written notice has been given to the Owner;
  - 9.10.2.3. a written statement that the Contractor knows of no substantial reason that the insurance will not be renewable to cover the period required by the Contract Documents
  - 9.10.2.4. Consent of Surety Company to Final Payment (Form 103); and,
  - 9.10.2.5. if required by the Owner, other data establishing payment or satisfaction of obligations, such as receipts, releases and waivers of liens, claims, security interests or encumbrances arising out of the Contract, to the extent and in such form as may be designated by the Owner.
- 9.10.3. The Contractor and his surety accepts and assumes responsibility, liability, and costs for and agrees to defend and hold harmless the Owner for and against any and all actions as a result of the Owner making final payment.
- 9.10.4. By submitting any Application for Payment to the Architect/Engineer the Contractor and his surety certify and declare that all bills for materials, supplies, utilities and for all other things furnished or caused to be furnished by the Contractor and all Subcontractors and used in the execution of the Contract will be fully paid upon receipt of Final Payment and that there are no unpaid obligations, liens, claims, security interests, encumbrances, liabilities and/or demands of State Agencies, subcontractors, suppliers, mechanics, laborers or any others resulting from or arising out of any work done, caused to be done or ordered to be done by the Contractor under the contract.
- 9.10.5. In consideration of the prior payments and the final payment made and all payments made for authorized changes, the Contractor releases and forever discharges the Owner from any and all obligations, liens, claims, security interests, encumbrances and/or liabilities arising by virtue of the contract and authorized

changes between the parties, either verbal or in writing, and any and all claims and demands of every kind and character whatsoever against the Owner, arising out of or in any way relating to the contract and authorized changes.

- 9.10.6. The date of Final Payment by the Owner shall constitute Final Acceptance of the Work. The determining date for the expiration of the warranty period shall be as specified in Paragraphs 3.5 and 12.2.2.
- 9.10.7. If, after Substantial Completion of the Work, final completion thereof is materially delayed through no fault of the Contractor or by issuance of Change Orders affecting final completion, and the Architect/Engineer so confirms, the Owner shall, upon application by the Contractor and certification by the Architect/Engineer, and without terminating the Contract, make payment of the balance due for that portion of the Work fully completed and accepted. If the remaining balance for Work not fully completed or corrected is less than retainage stipulated in the Contract Documents, and if bonds have been furnished, the written consent of surety to payment of the balance due for that portion of the Work fully completed and accepted shall be submitted by the Contractor to the Architect/Engineer prior to certification of such payment. Such payment shall be made under terms and conditions governing final payment, except that it shall not constitute a waiver of claims.
- 9.10.8. The making of final payment shall constitute a waiver of Claims by the Owner except those arising from:
- 9.10.8.1. liens, Claims, security interests or encumbrances arising out of the Contract and unsettled;
- 9.10.8.2. failure of the Work to comply with the requirements of the Contract Documents; or,
- 9.10.8.3. terms of special warranties required by the Contract Documents.
- 9.10.9. Acceptance of final payment by the Contractor, a Subcontractor, or material supplier, shall constitute a waiver of any and all obligations, liens, claims, security interests, encumbrances and/or liabilities against the Owner except those previously made in writing per the requirements of Paragraph 4.3 and as yet unsettled at the time of submission of the final Application for Payment.
- 9.10.10. The Owner's issuance of Final Payment does not constitute a waiver or release of any kind regarding any past, current, or future claim the Owner may have against the Contractor and/or the surety.

## **ARTICLE 10 – PROTECTION OF PERSONS AND PROPERTY**

### **10.1. SAFETY**

- 10.1.1. **Importance of Safety.** The Contractor and all Subcontractors (at any tier or level) recognize that safety is paramount at all times. The Contractor shall perform the work in a safe manner with the highest regard for safety of its employees and all other individuals and property at the work site. Contractor shall maintain its tools, equipment, and vehicles in a safe operating condition and take all other actions necessary to provide a safe working environment for performance of work required under this Contract. The Contractor is solely responsible for the means, methods, techniques, sequences and procedures for coordinating and constructing the Work, including all site safety, safety precautions, safety programs, and safety compliance with OSHA and all other governing bodies.
- 10.1.2. **Particular Safeguards.** (a) The Contractor shall erect and maintain, as required by Paragraphs 10.1.1 and 10.1.3, safeguards for safety and protection, including posting danger signs and other warnings against hazards, installing suitable barriers and lighting, promulgating safety regulations, and providing notification to all parties who may be impacted by the Contractor's operations. (b) When use or storage of explosives or other Hazardous Materials/Substances (defined below) or equipment are necessary for execution of the Work, the Contractor shall exercise utmost care and carry on such activities under supervision of properly qualified personnel. (c) The Contractor shall not encumber or load or permit any part of the construction site to be encumbered or loaded so as to endanger the safety of any person(s).
- 10.1.3. **Compliance with Safety Laws.** Contractor represents and warrants to Owner that it knows and understands all federal, state and local safety statutes, rules, and regulations (Laws) related to the work under this Contract. Contractor shall comply with these Laws. Contractor shall keep all material data safety sheets on site and available at all times.

- 10.1.4. **Remedy property damage.** The Contractor shall promptly remedy damage and loss to property caused in whole or in part by the Contractor, a Subcontractor of any tier or level, or anyone employed by any of them, or by anyone for whose acts they may be liable and for which the Contractor is responsible. The foregoing obligations of the Contractor are in addition to the Contractor's obligations under Paragraph 3.18.
- 10.1.5. **Designation of Safety Representative.** Unless the Contractor designates, in writing to the Owner and the Architect/Engineer, another responsible member of the Contractor's organization as the Safety Representative, the Contractor's superintendent is the Safety Representative. The Safety Representative is defined as that member of the Contractor's organization responsible for all safety under this Contract.
- 10.1.6. **Release/Indemnity of Owner and Architect/Engineer.** The Contractor agrees that the Owner and Architect/Engineer are not responsible for safety at the work site and releases them from all obligations and liability regarding safety at the work site. The Contractor shall indemnify and defend the Owner and the Architect/Engineer against and from all claims, liabilities, fines, penalties, orders, causes of action, judgments, losses, costs and expenses (including but not limited to court costs and reasonable attorney fees), arising from injuries and death to any persons and damage to real and personal property arising from, in connection with, or incidental to Contractor's safety responsibilities under this Contract.

## **10.2. HAZARDOUS MATERIALS/SUBSTANCES**

- 10.2.1. "Hazardous Materials/Substances" means any substance: (a) the presence of which requires investigation, or remediation under any federal, state or local statute, rule, regulation, ordinance, order, policy or common law; (b) that is or becomes defined as "hazardous waste," "hazardous substance," pollutant, or contaminant under any federal, state or local statute, rule, regulation, or ordinance or amendments thereto; (c) that is toxic, explosive, corrosive flammable, or otherwise hazardous and is or becomes regulated by any government authority, agency, board, commission or instrumentality of the United States, the state of Montana or any political subdivision thereof; (d) gasoline, diesel fuel or other petroleum hydrocarbons; (e) containing contains polychlorinated biphenyls (PCBs) or asbestos; or (f) the presence of which causes or threatens to cause a nuisance or trespass on the work site or adjacent property.
- 10.2.2. The Contractor is solely responsible for all compliance with all regulations, requirements, and procedures governing Hazardous Materials/Substances at the Work Site or that Contractor brings on the site. The Contractor is solely responsible for remediation, costs, damages, loss, and/or expenses for all Hazardous Materials/Substances brought to the site. The Contractor shall not and is strictly prohibited from purchasing and/or installing any asbestos-containing materials or products as part of the Work. Should the Contractor do so, the Contractor shall be solely responsible for the immediate remediation and all costs, damages, loss, and/or expenses per Paragraphs 10.1.6, 10.2.2, 10.2.3, and 10.2.4.
- 10.2.3. If the Contractor encounters Hazardous Materials/Substances during the course of the Work, whether or not identified in the Contract Documents, Work, the Contractor agrees that:
- 10.2.3.1. Encountering any Hazardous Materials/Substances during performance of the Work does not necessarily mean a change in conditions has occurred, nor is it evidence that the Contractor is due additional Contract Time or an increase in the Contract Sum. If encountering Hazardous Materials/Substances is determined to be a change in conditions to the Contract Documents, Paragraph 4.3 and Article 7 apply in determining any additional compensation or extension of time claimed by the Contractor.
- 10.2.3.2. The Contractor is solely responsible for securing the Work in accordance with this Article 10 involving any Hazardous Materials/Substances against unlawful, unregulated, or improper intrusion, disturbance, or removal. The Contractor shall implement protections and take protective actions throughout the performance of the Work to prevent exposure to workers, occupants, and contamination of the site or area.
- 10.2.3.3. If the Contractor is unable to or fails to properly secure the Work against unlawful, unregulated, or improper intrusion, disturbance, or removal of Hazardous Materials/Substances, the Contractor shall immediately implement protections and take protective actions, up to and

including stopping Work in the area or on the item affected, to prevent exposure to workers, occupants, and contamination of the site or area. The Contractor shall immediately notify the Owner and Architect in writing giving details of the failure and the corrective actions taken. If the condition is an emergency and notice cannot be provided in writing, then Contractor shall orally and immediately notify the Owner and Architect/Engineer of the condition followed by a full written explanation. In an emergency affecting safety of persons or property, the Contractor shall act, at the Contractor's discretion, to prevent threatened damage, injury or loss.

10.2.3.4. If the Contractor notifies the Owner and takes precautions in accordance with this Article 10 upon encountering materials/substances suspected of containing asbestos or polychlorinated biphenyls that are unidentified in the Contract Documents, the Owner shall verify if the unidentified material or substance contains asbestos or polychlorinated biphenyls and shall arrange for the removal or other measures as necessary to allow the Contractor to proceed with the Work. The Contract Time may be extended as appropriate if the Work affected is on the critical path and the Contract Sum shall be increased in the amount of the Contractor's reasonable additional costs as provided in Article 7. Should the Contractor fail to notify the Owner upon encountering asbestos, polychlorinated biphenyls, or materials/substances suspected of containing asbestos or polychlorinated biphenyls, that are unidentified in the Contract Documents, the Contractor is solely responsible for all mitigation in accordance with Paragraphs 10.1.6, 10.2.2, 10.2.3, and 10.2.4.

10.2.4. The Contractor shall indemnify, hold harmless, and defend the Owner from and against all claims, liabilities, fines, penalties, orders, causes of action, judgments, losses, costs and expenses, including but not limited to court costs and reasonable attorneys' fees, arising from, in connection with, or incidental to the Contractor's handling, disposal, encountering, or release of Hazardous Materials/Substances.

### **10.3. UTILITIES**

10.3.1. Underground Utilities: Buried utilities, including, but not limited to, electricity, gas, steam, air, water, telephone, sewer, irrigation, broadband coaxial computer cable, and fiber optic cables are very vulnerable and damage could result in loss of service. The telephone, broadband and fiber optic cables are especially sensitive and the slightest damage to these components will result in disruption of the operations of the campus.

10.3.2. "One Call" must be notified by phone and in writing at least 72 hours (3 business days) prior to digging to arrange and assist in the location of buried utilities in the field. (Dial 811). The Contractor shall mark the boundary of the work area. The boundary area shall be indicated with white paint and white flags. In winter, pink paint and flags will be accepted.

10.3.3. After buried utilities have been located, the Contractor shall be responsible for any utilities damaged while digging. Such responsibility shall include all necessary care including hand digging. Contractor's responsibility shall also include maintaining markings after initial locate. The area for such responsibility, unless otherwise indicated, shall extend 24 inches to either side of the marked center line of a buried utility line.

10.3.4. The Contractor's responsibility shall include repair or replacement of damaged utilities. The Contractor will also be responsible for all costs associated with reterminations and recertification.

10.3.5. Any buried utilities exposed by the operations of the Contractor shall be marked on the plans and adequately protected by the Contractor. If any buried utilities not located are exposed, the Contractor shall immediately contact the Owner and the Architect/Engineer. If, after exposing an unlocated buried utility, the Contractor continues digging without notifying Owner and Architect/Engineer and further damages the utility, the Contractor will be fully and solely responsible.

10.3.6. Damage to irrigation systems during seasons of no irrigation that are not immediately and adequately repaired and tested will require the Contractor to return when the system is in service to complete the repair.

10.3.7. In the event of a planned interruption of any existing utility service, the Contractor shall make arrangements with Owner at least 72 hours (3 business days) in advance. Shutdowns of the broadband

or fiber optic cables will normally require 5 working days' notice to the Owner. The Contractor shall bear all costs associated with the interruptions and restorations of service.

## **ARTICLE 11 - INSURANCE AND BONDS**

### **11.1. CONTRACTOR'S LIABILITY INSURANCE**

- 11.1.1. The Contractor shall purchase from and maintain in a company or companies lawfully authorized to do business in the State of Montana with a rating no less than "A-", such insurance as will protect the Contractor from claims set forth below which may arise out of or result from the Contractor's operations under the Contract and for which the Contractor may be legally liable, whether such operations be by the Contractor or by a Subcontractor or by anyone directly or indirectly employed by any of them, or by anyone for whose acts any of them may be liable:
- 11.1.1.1. claims under workers' compensation, disability benefit and other similar employee benefit acts which are applicable to the Work to be performed;
  - 11.1.1.2. claims for damages because of bodily injury, occupational sickness or disease, or death of the Contractor's employees;
  - 11.1.1.3. claims for damages because of bodily injury, sickness or disease, or death of any person other than the Contractor's employees;
  - 11.1.1.4. claims for damages insured by usual personal injury liability coverage;
  - 11.1.1.5. claims for damages, other than to the Work itself, because of injury to or destruction of tangible property, including loss of use resulting there from;
  - 11.1.1.6. claims for damages because of bodily injury, death of a person or property damage arising out of ownership, maintenance or use of a motor vehicle;
  - 11.1.1.7. claims for bodily injury or property damage arising out of completed operations; and,
  - 11.1.1.8. claims involving contractual liability insurance applicable to the Contractor's obligations under Paragraph 3.18.
- 11.1.2. The insurance required by Subparagraph 11.1.1 shall be written for not less than limits of liability specified in the Contract Documents or required by law, whichever coverage is greater. Coverages, whether written on an occurrence or claims-made basis, shall be maintained without interruption from date of commencement of the Work until termination of any coverage required to be maintained after final payment.
- 11.1.3. Certificates of insurance acceptable to the Owner shall be filed with the Owner prior to commencement of the Work. These certificates and the insurance policies required by this Paragraph 11.1 shall contain a provision that coverages afforded under the policies will not be canceled or allowed to expire at any time prior to Final Acceptance and then not until at least 30 days' prior written notice has been given to the Owner. If any of the foregoing insurance coverages are required to remain in force after final payment, an additional certificate evidencing continuation of such coverage shall be submitted with the final Application for Payment as required by Subparagraph 9.10.2. Information concerning reduction of coverage on account of revised limits or claims paid under the General Aggregate, or both, shall be furnished by the Contractor with reasonable promptness in accordance with the Contractor's information and belief.
- 11.1.4. At the request of the Owner, the Contractor shall provide copies of all insurance policies to the Owner.

### **11.2. INSURANCE, GENERAL REQUIREMENTS**

- 11.2.1. The Contractor shall maintain for the duration of the contract, at its cost and expense, insurance against claims for injuries to persons or damages to property, including contractual liability, which may arise from or in connection with the performance of the Work by the Contractor, its agents, employees,

representatives, assigns, or subcontractors. The Contractor is responsible for all deductibles regardless of policy or level of coverage. The Owner reserves the right to demand, and the Contractor agrees to provide, copies of any and all policies at any time.

- 11.2.2. **Hold Harmless and Indemnification:** The Contractor shall protect, defend, and save the state, its elected and appointed officials, agents, and employees, while acting within the scope of their duties as such, harmless from and against all claims, liabilities, demands, causes of action, and judgments whatsoever (including the cost of defense and reasonable attorney fees): 1) arising in favor of or asserted by third parties on account of damage to property, personal injury, or death which injury, death, or damage; or, 2) arising out of or resulting from performance or failure to perform, or omissions of services, or in any way results from the negligent acts or omissions of the Contractor, its agents, agents, or subcontractors.
- 11.2.3. **Contractor's Insurance:** insurance required under all sections herein shall be in effect for the duration of the contract that extends through the warranty period. Insurance required herein shall be provided by insurance policies issued only by insurance companies currently authorized to do business in the state of Montana. No Contractor or Sub-contractor shall commence any Work under this contract until all required insurance has been obtained. During the term of this contract, the Contractor shall, not less than thirty days prior to the expiration date of any policy for which a certificate of insurance is required, deliver to the Owner a certificate of insurance with respect to the renewal insurance policy. The Contractor shall furnish one copy of insurance certificates of insurance herein required, which shall specifically set forth evidence of all coverage required by these contract documents and which shall be signed by authorized representatives of the insurance company or companies evidencing that insurance as required herein is in force and will not be canceled, limited or restricted without thirty days' written notice by certified mail to the contractor and the Owner. The Contractor shall furnish to the Owner copies of any endorsements that are subsequently issued amending coverage or limits. Additionally, all certificates shall include the project name and A/E project number.
- 11.2.4. **Certificates of Insurance and Endorsements.** All certificates of insurance and the additional insured endorsements are to be received by the state prior to issuance of the Notice to Proceed. The contractor is responsible to ensure that all policies and coverages contain the necessary endorsements for the State being listed as an additional insured. The state reserves the right to require complete copies of all insurance policies at any time to verify coverage. The contractor shall notify the state within 30 days of any material change in coverage.

### **11.3. WORKERS' COMPENSATION INSURANCE**

- 11.3.1. The Contractor shall carry **Workers' Compensation Insurance**. Such Workers' Compensation Insurance shall protect the Contractor from claims made by his own employees, the employees of any Sub-contractor, and also claims made by anyone directly or indirectly employed by the Contractor or Sub-contractor. The Contractor shall require each Sub-contractor similarly to provide Workers' Compensation Insurance.

### **11.4. COMMERCIAL GENERAL LIABILITY INSURANCE**

- 11.4.1. Each Contractor shall carry per occurrence coverage **Commercial General Liability Insurance** including coverage for premises; operations; independent contractor's protective; products and completed operations; products and materials stored off-site; broad form property damage and comprehensive automobile liability insurance with not less than the following limits of liability:
  - 11.4.1.1. **\$1,000,000 per occurrence; aggregate limit of \$2,000,000;**
- 11.4.2. The **Commercial General and Automobile Liability Insurance** shall provide coverage for both bodily injury, including accidental death, sickness, disease, occupational sickness or disease, personal injury liability coverage and property damage which may arise out of the work under this contract, or operations incidental thereto, whether such work and operations be by the Contractor or by any Subcontractor or by anyone directly or indirectly employed by the Contractor or by Sub-contractor, or by anyone for whose acts any of them may be liable. The Contractor shall maintain the liability insurance required herein for a period of not less than one year after final payment or anytime the Contractor goes on to the location of the project.



- 11.4.3. The Contractor's liability insurance policies shall list the STATE OF MONTANA as an additional insured. **AN ADDITIONAL INSURED ENDORSEMENT DOCUMENT SHALL BE SUBMITTED WITH THE CERTIFICATES OF INSURANCE.** The STATE OF MONTANA includes its officers, elected and appointed officials, employees and volunteers and political subdivisions thereof. Should the Contractor not be able to list the state as an additional insured, the Contractor shall purchase a per occurrence Owner's/Contractor's Protective Policy (OCP) with the STATE OF MONTANA as the insured party in the same occurrence and aggregate limits as that indicated above for the Contractor's Commercial General Liability Policy.
- 11.4.4. Property damage liability insurance shall be written without any exclusion for injury to or destruction of any building, structure, wires, conduits, pipes, or other property above or below the surface of the ground arising out of the blasting, explosion, pile driving, excavation, filling, grading or from the moving, shoring, underpinning, raising, or demolition of any building or structure or structural support thereof.
- 11.4.5. The Contractor's insurance coverage shall be PRIMARY insurance as respects the State, its officers, elected and appointed officials, employees and volunteers. Any insurance or self-insurance maintained by the state, its officers, elected and appointed officials, employees and volunteers shall be excess of the Contractor's insurance and shall not contribute to it. NO WAIVERS OF SUBROGATION OR ENDORSEMENTS LIMITING, TRANSFERRING, OR OTHERWISE INDEMNIFYING LIABLE OR RESPONSIBLE PARTIES OF THE CONTRACTOR OR ANY SUBCONTRACTOR WILL BE ACCEPTED.

## **11.5. PROPERTY INSURANCE (ALL RISK)**

- 11.5.1. New Construction (for projects involving new construction): At its sole cost and expense, the contractor shall keep the building and all other improvements on the premises insured throughout the term of the agreement against the following hazards:
- 11.5.1.1. Loss or damage by fire and such other risks (including earthquake damage for those areas with a shaking level at 10g or above as indicated on the seismic map, <http://rmtd.mt.gov/Portal/62/aboutus/publications/files/NEHRP.pdf> in an amount sufficient to permit such insurance to be written at all times on a replacement cost basis. This may be insured against by attachment of standard form extended coverage endorsement to fire insurance policies. Certificates of Insurance MUST indicate earthquake coverage if coverage is required per the above referenced map.
- 11.5.1.2. Loss or damage from leakage or sprinkler systems now or hereafter installed in any building on the premises.
- 11.5.1.3. Loss or damage by explosion of steam boilers, pressure vessels, and oil or gasoline storage tanks, or similar apparatus now or hereafter installed in a building or buildings on the premises.
- 11.5.2. Building Renovation (for projects involving building renovation or remodeling):
- 11.5.2.1. The contractor shall purchase and maintain Builder's Risk/Installation insurance on a "special causes of loss" form (so called "all risk") for the cost of the work and any subsequent modifications and change orders. The contractor is not responsible for insuring the existing structure for Builder's Risk/Installation insurance.
- 11.5.2.2. At its sole cost and expense, the contractor shall insure all property construction on the premises throughout the term of the agreement against the following hazards:
- 11.5.2.2.1. Loss or damage by fire and such other risks (including earthquake damage for those areas with a shaking level at 10g or above as indicated on the seismic map at <http://rmtd.mt.gov/Portal/62/aboutus/publications/files/NEHRP.pdf> in an amount sufficient to permit such insurance to be written at all times on a replacement cost basis. This may be insured against by attachment of standard form extended coverage endorsement to fire policies. Certificates of Insurance MUST indicate earthquake coverage if coverage is required per the above referenced map.

- 11.5.2.2.2. Loss or damage from leakage or sprinkler systems now or hereafter installed in any building on the premises.
- 11.5.2.2.3. Loss or damage by explosion of steam boilers, pressure vessels, oil or gasoline storage tanks, or similar apparatus now or hereafter installed in a building or buildings on the premises.

## **11.6. ASBESTOS ABATEMENT INSURANCE**

- 11.6.1. If Asbestos Abatement is identified as part of the Work under this contract, the Contractor or any subcontractor involved in asbestos abatement shall purchase and maintain **Asbestos Liability Insurance** for coverage of bodily injury, sickness, disease, death, damages, claims, errors or omissions regarding the asbestos portion of the work ***in addition to*** the CGL Insurance by reason of any negligence in part or in whole, error or omission committed or alleged to have been committed by the Contractor or anyone for whom the Contractor is legally liable.
- 11.6.2. Such insurance shall be in "per occurrence" form and shall clearly state on the certificate that asbestos work is included in the following limits:
  - 11.6.2.1. **\$1,000,000 per occurrence; aggregate limit of \$2,000,000.**
- 11.6.3. Asbestos Liability Insurance as carried by the asbestos abatement subcontractor in these limits in lieu of the Contractor's coverage is acceptable provided the Contractor and the State of Montana are named as additional insureds and that the abatement subcontractor's insurance is PRIMARY as respects both the Owner and the Contractor. If the Contractor or any other subcontractor encounters asbestos, all operations shall be suspended until abatement with the associated air monitoring clearances are accomplished. The certificate of coverage shall be provided by the asbestos abatement subcontractor to both the Contractor and the Owner.

## **11.7. PERFORMANCE BOND AND LABOR & MATERIAL PAYMENT BOND (BOTH ARE REQUIRED ON THIS PROJECT)**

- 11.7.1. For contracts equal to or greater than \$50,000 The Contract shall furnish a Performance Bond in the amount of 100% of the contract price as security for the faithful performance of his contract (18-2-201 MCA). The Contractor shall also furnish a Labor and Material Payment Bond in the amount of 100% of the contract price as security for the payment of all persons performing labor and furnishing materials in connection therewith (18-2-201MCA). The bonds shall be executed on forms furnished by the Owner and no other forms or endorsements will be acceptable. The bonds shall be signed in compliance with state statutes (33-17-1111 MCA). Bonds shall be secured from a state licensed bonding company. Power of Attorney is required with each bond. Attorneys-in-fact who sign contract bonds must file with each bond a certified and effectively dated copy of their power of attorney:
  - 11.7.1.1. one original copy shall be furnished with each set of bonds.
  - 11.7.1.2. Others furnished with a set of bonds may be copies of that original.
- 11.7.2. The Owner reserves the right at any time during the performance of Work to require bonding of Subcontractors provided by the General Contractor. Should this occur, the Owner will cover the direct cost. This shall not be construed as to in any way affect the relationship between the General Contractor and his Subcontractors.
- 11.7.3. Surety must have an endorsement stating that their guarantee of Contractor's performance automatically covers the additional contract time added to a Contractor's contract by Change Order.
- 11.7.4. A change in the Contractor's organization shall not constitute grounds for Surety to claim a discharge of their liability and requires an endorsement from Surety so stating.
- 11.7.5. Except as noted below, the Contractor is required to notify Surety of any increase in the contract amount resulting from a Change Order within 48 hours of signing and submitting a Change Order and shall submit a copy of Surety's written acknowledgment and consent to Owner before a Change Order can be

approved. The Surety's written acknowledgment and consent on the Change Order form shall also satisfy this consent requirement.

11.7.5.1. Surety consent shall not be required on Change Order(s) which, in the aggregate total amount of all Changes Orders, increase the original contract amount by less than 10%. However, the Contractor is still required to notify Surety of any increase in contract amount resulting from a Change Order(s) within 48 hours of signing and submitting every Change Order.

11.7.5.2. Surety is fully obligated to the Owner for the full contract amount, inclusive of all Change Orders, regardless of whether or not written acknowledgement and consent is received and regardless of whether or not the aggregate total of all Change Orders is more or less than 10% of the original contract amount.

11.7.5.3. A fax with hard copy to follow of Surety's written acknowledgment and consent is acceptable. If hard copy is not received by Owner before Application for Payment on any portion or all of said Change Order, it will not be accepted by Owner for payment.

11.7.6. The Surety must take action within 30 days of notice of default on the part of the Contractor or of any claim on bonds made by the Owner or any Subcontractor or supplier.

## **ARTICLE 12 - UNCOVERING AND CORRECTION OF WORK**

### **12.1. UNCOVERING OF WORK**

12.1.1. If a portion of the Work is covered contrary to the Architect/Engineer's request or to requirements specifically expressed in the Contract Documents, it must, if required in writing by the Architect/Engineer, be uncovered for the Architect/Engineer's examination and be replaced at the Contractor's expense without change in the Contract Time.

12.1.2. If a portion of the Work has been covered which the Architect/Engineer has not specifically requested to examine prior to it being covered, the Architect/Engineer may request to see such Work and it shall be uncovered by the Contractor. If such Work is in accordance with the Contract Documents, costs of uncovering and replacement shall, by appropriate Change Order, be at the Owner's expense. If such Work is not in accordance with the Contract Documents, correction shall be at the Contractor's expense unless the condition was caused by the Owner or a separate contractor in which event the Owner shall be responsible for payment of such costs.

### **12.2. CORRECTION OF WORK**

#### **12.2.1. BEFORE OR AFTER SUBSTANTIAL COMPLETION**

12.2.1.1. The Contractor shall promptly correct Work that fails to conform to the requirements of the Contract Documents or that is rejected by the Architect/Engineer, whether discovered before or after Substantial Completion and whether or not fabricated, installed or completed. Costs of correcting such rejected Work, including additional testing and inspections and compensation for the Architect/Engineer's services and expenses made necessary thereby, shall be at the Contractor's expense. The Contractor is responsible to discover and correct all defective work and shall not rely upon the Architect/Engineer's or Owner's observations.

12.2.1.2. Rejection and Correction of Work in Progress. During the course of the Work, the Contractor shall inspect and promptly reject any Work that:

12.2.1.2.1. does not conform to the Construction Documents; or,

12.2.1.2.2. does not comply with any applicable law, statute, building code, rule or regulation of any governmental, public and quasi-public authorities, and agencies having jurisdiction over the Project.

12.2.1.3. The Contractor shall promptly correct or require the correction of all rejected Work, whether observed before or after Substantial Completion. The Contractor shall bear all costs of

correcting such Work, including additional testing, inspections, and compensation for all services and expenses necessitated by such corrective action.

#### **12.2.2. AFTER SUBSTANTIAL COMPLETION AND AFTER FINAL ACCEPTANCE**

12.2.2.1. In addition to the Contractor's obligations under Paragraph 3.5, if, within one year after the date of Final Acceptance of the Work or designated portion thereof or after the date for commencement of warranties, or by terms of an applicable special warranty required by the Contract Documents, any of the Work is found to be not in accordance with the requirements of the Contract Documents, the Contractor shall correct it promptly after receipt of written notice from the Owner to do so unless the Owner has previously given the Contractor a written acceptance of such condition. The Owner shall give such notice promptly after discovery of the condition. During the one-year period for correction of Work, if the Owner fails to notify the Contractor and give the Contractor an opportunity to make the correction, the Owner waives the rights to require correction by the Contractor and to make a claim for breach of warranty. If the Contractor fails to correct nonconforming Work within a reasonable time during that period after receipt of notice from the Owner or Architect/Engineer, the Owner may correct it in accordance with Paragraph 2.3.

12.2.2.1.1. The Contractor shall remedy any and all deficiencies due to faulty materials or workmanship and pay for any damage to other work resulting there from, which shall appear within the period of Substantial Completion through one (1) year from the date of Final Acceptance in accordance with the terms and conditions of the Contract and with any special guarantees or warranties provided in the Contract Documents. The Owner shall give notice of observed deficiencies with reasonable promptness. All questions, claims or disputes arising under this Article shall be decided by the Architect/Engineer. All manufacturer, product and supplier warranties are in addition to this Contractor warranty.

12.2.2.1.2. The Contractor shall respond within seven (7) days after notice of observed deficiencies has been given and he shall proceed to immediately remedy these deficiencies.

12.2.2.1.3. Should the Contractor fail to respond to the notice or not remedy those deficiencies; the Owner shall have this work corrected at the expense of the Contractor.

12.2.2.1.4. Latent defects shall be in addition to those identified above and shall be the responsibility of the Contractor per the statute of limitations for a written contract (27-2-208 MCA) starting from the date of Final Acceptance.

12.2.2.2. The one-year period for correction of Work shall be extended with respect to portions of Work first performed after Substantial Completion by the period of time between Substantial Completion and the actual performance of the Work.

12.2.2.3. The one-year period for correction of Work shall not be extended by corrective Work performed by the Contractor pursuant to this Paragraph 12.2.

12.2.3. The Contractor shall remove from the site portions of the Work which are not in accordance with the requirements of the Contract Documents and are neither corrected by the Contractor nor accepted by the Owner.

12.2.4. The Contractor shall bear the cost of correcting destroyed or damaged construction, whether completed or partially completed, of the Owner or separate contractors caused by the Contractor's correction or removal of Work which is not in accordance with the requirements of the Contract Documents.

12.2.5. Nothing contained in this Paragraph 12.2 shall be construed to establish a period of limitation with respect to other obligations which the Contractor might have under the Contract Documents. Establishment of the one-year period for correction of Work as described in Subparagraph 12.2.2 relates only to the specific obligation of the Contractor to correct the Work, and has no relationship to the time within which the obligation to comply with the Contract Documents may be sought to be enforced, nor to the time within which proceedings may be commenced to establish the Contractor's liability with respect to the Contractor's obligations other than specifically to correct the Work.

### **12.3. ACCEPTANCE OF NONCONFORMING WORK**

- 12.3.1. If the Owner prefers to accept Work which is not in accordance with the requirements of the Contract Documents, the Owner may do so instead of requiring its removal and correction, in which case the Contract Sum will be reduced as appropriate and equitable. Such adjustment shall be effected whether or not final payment has been made.

## **ARTICLE 13 - MISCELLANEOUS PROVISIONS**

### **13.1. GOVERNING LAW**

- 13.1.1. The Contract shall be governed by the laws of the State of Montana and venue for all legal proceedings shall be the First Judicial District, Lewis & Clark County.

### **13.2. SUCCESSORS AND ASSIGNS**

- 13.2.1. The Owner and Contractor respectively bind themselves, their partners, successors, assigns and legal representatives to the other party hereto and to partners, successors, assigns and legal representatives of such other party in respect to covenants, agreements and obligations contained in the Contract Documents. Neither party to the Contract shall assign the Contract as a whole without written consent of the other. If either party attempt to make such assignment without such consent, that party shall nevertheless remain legally responsible for all obligations under the Contract.

### **13.3. WRITTEN NOTICE**

- 13.3.1. Written notice shall be deemed to have been duly served if delivered in person to the individual or a member of the firm or entity or to an officer of the corporation for which it was intended, or if delivered at or sent by registered or certified mail to the last business address known to the party giving notice.

### **13.4. RIGHTS AND REMEDIES**

- 13.4.1. Duties and obligations imposed by the Contract Documents and rights and remedies available thereunder shall be in addition to and not a limitation of duties, obligations, rights and remedies otherwise imposed or available by law.
- 13.4.2. No action or failure to act by the Owner, Architect/Engineer or Contractor shall constitute a waiver of a right or duty afforded them under the Contract, nor shall such action or failure to act constitute approval of or acquiescence in a breach thereunder, except as may be specifically agreed in writing.

### **13.5. TESTS AND INSPECTIONS**

- 13.5.1. Tests, inspections and approvals of portions of the Work required by the Contract Documents or by laws, ordinances, rules, regulations or orders of public authorities having jurisdiction shall be made at an appropriate time. Unless otherwise provided, the Contractor shall make arrangements for such tests, inspections and approvals with an independent testing laboratory or entity acceptable to the Owner, or with the appropriate public authority, and shall bear all related costs of tests, inspections and approvals. The Contractor shall give the Architect/Engineer timely notice of when and where tests and inspections are to be made so that the Architect/Engineer may be present for such procedures. The Owner shall bear costs of tests, inspections or approvals which do not become requirements until after bids are received or negotiations concluded.
- 13.5.2. If the Architect/Engineer, Owner or public authorities having jurisdiction determine that portions of the Work require additional testing, inspection or approval not included under Subparagraph 13.5.1, the Architect/Engineer will, upon written authorization from the Owner, instruct the Contractor to make arrangements for such additional testing, inspection or approval by an entity acceptable to the Owner, and the Contractor shall give timely notice to the Architect/Engineer of when and where tests and inspections are to be made so that the Architect/Engineer may be present for such procedures. Such costs, except as provided in Subparagraph 13.5.3 shall be at the Owner's expense.

- 13.5.3. If such procedures for testing, inspection or approval under Subparagraphs 13.5.1 and 13.5.2 reveal failure of the portions of the Work to comply with requirements established by the Contract Documents, all costs made necessary by such failure including those of repeated procedures and compensation for the Architect/Engineer's services and expenses shall be at the Contractor's expense.
- 13.5.4. Required certificates of testing, inspection or approval shall, unless otherwise required by the Contract Documents, be secured by the Contractor and promptly delivered to the Architect/Engineer.
- 13.5.5. If the Architect/Engineer is to observe tests, inspections or approvals required by the Contract Documents, the Architect/Engineer will do so promptly and, where practicable, at the normal place of testing.
- 13.5.6. Tests or inspections conducted pursuant to the Contract Documents shall be made promptly to avoid unreasonable delay in the Work.

### **13.6. INTEREST**

- 13.6.1. Payments due and unpaid under the Contract Documents shall bear interest from the date payment is due at such rate as the parties may agree upon in writing or, in the absence thereof, at the legal rate prevailing from time to time at the place where the Project is located.

### **13.7. COMMENCEMENT OF STATUTORY LIMITATION PERIOD**

- 13.7.1. As between the Owner and Contractor:

- 13.7.1.1. **Before Substantial Completion.** As to acts or failures to act occurring prior to the relevant date of Substantial Completion, any applicable statute of limitations shall commence to run and any alleged cause of action shall be deemed to have accrued in any and all events not later than such date of Substantial Completion;

- 13.7.1.2. **Between Substantial Completion and Final Certificate for Payment.** As to acts or failures to act occurring subsequent to the relevant date of Substantial Completion and prior to issuance of the final Certificate for Payment, any applicable statute of limitations shall commence to run and any alleged cause of action shall be deemed to have accrued in any and all events not later than the date of issuance of the final Certificate for Payment; and,

- 13.7.1.3. **After Final Payment.** As to acts or failures to act occurring after the relevant date of issuance of the final Certificate for Payment, any applicable statute of limitations shall commence to run and any alleged cause of action shall be deemed to have accrued in any and all events not later than the date of any act or failure to act by the Contractor pursuant to any Warranty provided under Paragraph 3.5, the date of any correction of the Work or failure to correct the Work by the Contractor under Paragraph 12.2, or the date of actual commission of any other act or failure to perform any duty or obligation by the Contractor or Owner, whichever occurs last.

### **13.8. PAYROLL AND BASIC RECORDS**

- 13.8.1. Payrolls and basic records pertaining to the project shall be kept on a generally recognized accounting basis and shall be available to the Owner, Legislative Auditor, the Legislative Fiscal Analyst or his authorized representative at mutually convenient times. Accounting records shall be kept by the Contractor for a period of three years after the date of the Owner's Final Acceptance of the Project.

## **ARTICLE 14 – TERMINATION OR SUSPENSION OF THE CONTRACT**

### **14.1. TERMINATION BY THE CONTRACTOR**

- 14.1.1. The Contractor may terminate the Contract if the Work is stopped for a period of 30 consecutive days through no act or fault of the Contractor or a Subcontractor, Sub-subcontractor or their agents or employees or any other persons or entities performing portions of the Work under direct or indirect contract with the Contractor, for any of the following reasons:

- 14.1.1.1. issuance of an order of a court or other public authority having jurisdiction which requires all Work to be stopped; or,
- 14.1.1.2. an act of government, such as a declaration of national emergency which requires all Work to be stopped.
- 14.1.2. The Contractor may terminate the Contract if, through no act or fault of the Contractor or a Subcontractor, Sub-subcontractor or their agents or employees or any other persons or entities performing portions of the Work under direct or indirect contract with the Contractor, repeated suspensions, delays or interruptions of the entire Work by the Owner as described in Paragraph 14.3 constitute in the aggregate more than 100 percent of the total number of days scheduled for completion, or 120 days in any 365-day period, whichever is less.
- 14.1.3. If one of the reasons described in Subparagraph 14.1.1 or 14.1.2 exists, the Contractor may, upon seven days' written notice to the Owner and Architect/Engineer, terminate the Contract and recover from the Owner payment for Work executed and for proven loss with respect to materials, equipment, tools, and construction equipment and machinery, including reasonable overhead and profit but not damages.
- 14.1.4. If the Work is stopped for a period of 60 consecutive days through no act or fault of the Contractor or a Subcontractor or their agents or employees or any other persons performing portions of the Work under contract with the Contractor because the Owner has persistently failed to fulfill the Owner's obligations under the Contract Documents with respect to matters important to the progress of the Work, the Contractor may, upon seven additional days' written notice to the Owner and the Architect/Engineer, terminate the Contract and recover from the Owner as provided in Subparagraph 14.1.3.

#### **14.2. TERMINATION BY THE OWNER FOR CAUSE**

- 14.2.1. The Owner may terminate the Contract if the Contractor:
  - 14.2.1.1. persistently or repeatedly refuses or fails to supply enough properly skilled workers or proper materials;
  - 14.2.1.2. fails to make payment to Subcontractors for materials or labor in accordance with the respective agreements between the Contractor and the Subcontractors;
  - 14.2.1.3. persistently disregards laws, ordinances, or rules, regulations or orders of a public authority having jurisdiction; or,
  - 14.2.1.4. otherwise is guilty of any breach of a provision of the Contract Documents.
- 14.2.2. When any of the above reasons exist, the Owner, upon certification by the Architect/Engineer that sufficient cause exists to justify such action, may without prejudice to any other rights or remedies of the Owner and after giving the Contractor and the Contractor's surety, if any, seven days' written notice, terminate employment of the Contractor and may, subject to any prior rights of the surety:
  - 14.2.2.1. take possession of the site and of all materials, equipment, tools, and construction equipment and machinery thereon owned by the Contractor;
  - 14.2.2.2. accept assignment of subcontracts pursuant to Paragraph 5.4; and,
  - 14.2.2.3. finish the Work by whatever reasonable method the Owner may deem expedient. Upon request of the Contractor, the Owner shall furnish to the Contractor a detailed accounting of the costs incurred by the Owner in finishing the Work.
- 14.2.3. When the Owner terminates the Contract for one of the reasons stated in Subparagraph 14.2.1, the Contractor shall not be entitled to receive further payment until the Work is finished.
- 14.2.4. If the unpaid balance of the Contract Sum exceeds costs of finishing the Work, including compensation for the Architect/Engineer's services and expenses made necessary thereby, and other damages incurred

by the Owner and not expressly waived, such excess shall be paid to the Contractor. If such costs and damages exceed the unpaid balance, the Contractor shall pay the difference to the Owner. The amount to be paid to the Contractor or Owner, as the case may be, shall be certified by the Architect/Engineer, upon application, and this obligation for payment shall survive termination of the Contract.

#### **14.3. SUSPENSION BY THE OWNER FOR CONVENIENCE**

14.3.1. The Owner may, without cause, order the Contractor in writing to suspend, delay or interrupt the Work in whole or in part for such period of time as the Owner may determine.

14.3.2. The Contract Sum and Contract Time shall be adjusted for increases in the cost and time caused by suspension, delay or interruption as described in Subparagraph 14.3.1. Adjustment of the Contract Sum shall include profit. No adjustment shall be made to the extent:

14.3.2.1. that performance is, was or would have been so suspended, delayed or interrupted by another cause for which the Contractor is responsible; or,

14.3.2.2. that an equitable adjustment is made or denied under another provision of the Contract.

#### **14.4. TERMINATION BY THE OWNER FOR CONVENIENCE**

14.4.1. The Owner may, at any time, terminate the Contract for the Owner's convenience and without cause.

14.4.2. Upon receipt of written notice from the Owner of such termination for the Owner's convenience, the Contractor shall:

14.4.2.1. cease operations as directed by the Owner in the notice;

14.4.2.2. take actions necessary, or that the Owner may direct, for the protection and preservation of the Work, and;

14.4.2.3. except for Work directed to be performed prior to the effective date of termination stated in the notice, terminate all existing subcontracts and purchase orders and enter into no further subcontracts and purchase orders.

14.4.3. In case of such termination for the Owner's convenience, the Contractor shall be entitled to receive payment for Work executed, and costs incurred by reason of such termination, along with reasonable overhead and profit on the Work not executed. The Contractor shall provide a full and complete itemized accounting of all costs.

### **ARTICLE 15 – EQUAL OPPORTUNITY**

**15.1.** The Contractor and all Sub-contractors shall not discriminate against any employee or applicant for employment because of race, color, sex, pregnancy, childbirth or medical conditions related to pregnancy or childbirth, political or religious affiliation or ideas, culture, creed, social origin or condition, genetic information, sexual orientation, gender identity or expression, national origin, ancestry, age, disability, military service or veteran status, or marital status, or physical or mental disability and shall comply with all Federal and State laws concerning fair labor standards and hiring practices. The Contractor shall ensure that applicants are employed, and that employees are treated during employment, without regard to race, color, sex, pregnancy, childbirth or medical conditions related to pregnancy or childbirth, political or religious affiliation or ideas, culture, creed, social origin or condition, genetic information, sexual orientation, gender identity or expression, national origin, ancestry, age, disability, military service or veteran status, or marital status, or physical or mental disability.

**15.2.** Such action shall include, but not be limited to the following: employment, upgrading, demotion or transfer; recruitment or recruitment advertising; layoff or termination; rates of pay or other forms of compensation; and selection for training, including apprenticeship. The Contractor agrees to post in conspicuous places available to employees and applicants for employment, notices setting forth the policies of non-discrimination.

**15.3.** The Contractor and all Sub-contractors shall, in all solicitations or advertisements for employees placed by them or on their behalf, state that all qualified applicants will receive consideration for employment without regard



to race, color, sex, pregnancy, childbirth or medical conditions related to pregnancy or childbirth, political or religious affiliation or ideas, culture, creed, social origin or condition, genetic information, sexual orientation, gender identity or expression, national origin, ancestry, age, disability, military service or veteran status, or marital status, or physical or mental disability.

[END OF GENERAL CONDITIONS]

## **SUPPLEMENTAL CONDITIONS OF THE CONTRACT FOR CONSTRUCTION**

(REVISED OCTOBER 2019)

### FOR STATE OF MONTANA GENERAL CONDITIONS

#### **ARTICLE 1 – GENERAL PROVISIONS**

##### **1.1 BASIC DEFINITIONS**

###### **1.1.3 SPECIFICATIONS**

**1.1.3.1 ADD:** “Approved”: When used to convey Architect’s/Engineer’s action on Contractor’s submittals, applications, and requests, “approved” is limited to Architect’s/Engineer’s duties and responsibilities as stated in the Conditions of the Contract.

**1.1.3.2 ADD:** “Directed”: A command or instruction by Architect/Engineer. Other terms including “requested,” “authorized,” “selected,” “required,” and “permitted” have the same meaning as “directed.”

**1.1.3.3 ADD:** “Indicated”: Requirements expressed by graphic representations or in written form on Drawings, in Specifications, and in other Contract Documents. Other terms including “shown,” “noted,” “scheduled,” and “specified” have the same meaning as “indicated.”

**1.1.3.4 ADD:** “Regulations”: Laws ordinances, statutes, and lawful orders issued by authorities having jurisdiction, and rules, conventions, and agreements within the construction industry that control performance of the Work.

**1.1.3.5 ADD:** “Furnish”: Supply and deliver to Project site, ready for unloading, unpacking, assembly, installation, and similar operations.

**1.1.3.6 ADD:** “Install”: Operations at Project site including unloading, temporarily shoring, unpacking, assembling, erecting, placing, anchoring, applying, working to dimension, finishing, curing, protecting, cleaning, and similar operations.

**1.1.3.7 ADD:** “Provide”: Furnish and install, complete and ready for the intended use.

**1.1.3.8 ADD:** “Project site”: Space available for performing construction activities. The extent of Project site is shown on Drawings and may or may not be identical with the description of the land or portion of the building on which the Project is to be built.

**1.6.1 Insert** in the sixth line: “All documents which constitute the instruments of service are the property of the Owner.” In lieu of the phrase “Unless otherwise indicated, the Architect/Engineer and the Architect/Engineer’s consultants shall be deemed the authors of them... except as defined in the Owner’s Contract with the Architect/Engineer.”

#### **ARTICLE 2 – THE OWNER**

##### **2.1 THE STATE OF MONTANA**

**2.1.1.1 ADD:** The State of Montana includes its officers, elected and approved officials, employees and volunteers, and political subdivisions thereof. The State of Montana and Montana State University are synonymous throughout the contract documents.

#### **ARTICLE 3 – THE CONTRACTOR**

##### **3.3 SUPERVISION AND CONSTRUCTION PROCEDURES**

###### **3.3.6 ADD: PRODUCT DELIVERY, STORAGE AND HANDLING**

**3.3.6.1 ADD:** Deliver, store, and handle products using means and methods that will prevent damage, deterioration, and loss, including theft and vandalism. Comply with manufacturer’s written instructions.

**3.3.6.2 ADD: DELIVERY AND HANDLING:**

**3.3.6.2.1 ADD:** Schedule delivery to minimize long-term storage at Project site and to prevent overcrowding of construction spaces.

**3.3.6.2.2 ADD:** Coordinate delivery with installation time to ensure minimum holding time for items that are flammable, hazardous, easily damaged, or sensitive to deterioration, theft, and other losses.

**3.3.6.2.3 ADD:** Deliver products to Project site in an undamaged condition in manufacturer’s original sealed container or other packaging system, complete with labels and instructions for handling, storing, unpacking, protecting, and installing.

**3.3.6.2.4 ADD:** Inspect products on delivery to determine compliance with the Contract Documents and to determine that products are undamaged and property protected.

**3.3.6.3 ADD: STORAGE**

**3.3.6.3.1 ADD:** Store products to allow for inspection and measurement of quantity or counting of units

**3.3.6.3.2 ADD:** Store materials in a manner that will not endanger Project structure.

**3.3.6.3.3 ADD:** Store products that are subject to damage by the elements under cover in a weathertight enclosure above ground, with ventilation adequate to prevent condensation.

**3.3.6.3.4 ADD:** Protect foam plastic from exposure to sunlight, except to extent necessary for period of installation and concealment.

**3.3.6.3.5 ADD:** Comply with product manufacturer’s written instructions for temperature, humidity, ventilation, and weather-protection requirements for storage.

**3.3.6.3.6 ADD:** Protect stored products from damage and liquids from freezing.

**3.10 CONSTRUCTION SCHEDULES**

**3.10.1.1 ADD:** A pre-construction meeting will be held at a time mutually agreed upon by the Owner, Architect/Engineer and Contractor at Campus Planning, Design and Construction, Montana State University, Bozeman, Montana. The contractor shall confirm the Contractor’s Construction Schedule for the Work. Coordination of operating requirements of the affected buildings, and surrounds, schedule of activities and Owner requirements will be discussed, as well as the order in which the Contractor intends to pursue the work. This schedule will be reviewed and must be mutually agreed upon by the Architect, Contractor and Owner.

**3.11 DOCUMENTATION AND AS-BUILT CONDITIONS AT THE SITE**

**3.11.4 ADD:** The contractor shall maintain at the site two (2) construction reference sets of all specifications, drawings, approved shop drawings, change orders and other modifications, addenda, schedules and instructions, in good order.

**3.11.4.1 ADD:** The record drawings shall be two (2) sets of black (or blue) and white prints of the drawings on which the contractor must record all “red line” changes during the course of construction and will include references to change order numbers, field directives, etc., and their dates. This record set shall be maintained separate and apart from documents used for construction reference. This set will be available for review by the project consultant, architect, engineer and MSU project manager at all times.

**3.11.4.2 ADD:** All as-built conditions shall be kept current and the contractor shall not permanently conceal or cover any work until all required information has been recorded.

**3.11.4.3 ADD:** All survey and exterior underground utilities shall be recorded using the spatial reference, Montana State Plane, NAD 83, CORS 96, Lambert Conformal Conic. The National Geodetic Survey publishes NAD 83

coordinates in the metric system (i.e., meters). The conversion factor that should be used to convert between English and metric systems is the international conversion factor of 1 ft. = 0.3048 m. coordinate system.

**3.11.4.4 ADD:** In marking any as-built conditions, the contractor shall ensure that such drawings indicate by measured dimension to building corners or other permanent monuments the exact locations of all piping, conduit or utilities concealed in concrete slabs, behind walls or ceilings or underground. Record drawings shall be made to scale and shall also include exact locations of valves, pull boxes and similar items as required for maintenance or repair service.

**3.11.4.5 ADD:** The contractor shall prepare and maintain a binder with all project warranty information. This will be provided to the project consultant, architect or engineer at final acceptance.

### **3.12.1 DEFINITIONS:**

**3.12.1.4 ADD:** Products: Items obtained for incorporating into the Work, whether purchased for Project or taken from previously purchased stock. The term “product” includes the terms “material,” “equipment,” “system,” and terms of similar intent.

**3.12.1.5 ADD:** Named Products: Items identified by manufacturer’s product name, including make or model number or other designation shown or listed in manufacturer’s published product literature that is current as of date of the Contract Documents.

**3.12.1.6 ADD:** New Products: Items that have not previously been incorporated into another project or facility. Products salvaged or recycled from other projects are not considered new products.

**3.12.1.7 ADD:** Comparable Products: Product that is demonstrated and approved through submittal process to have the indicated qualities related to type, function, dimension, in-service performance, physical properties, appearance, and other characteristics that equal or exceed those of specified product.

**3.12.1.8 ADD:** Basis-of-Design Product Specification: A specification in which a specific manufacturer’s product is named and accompanied by the words “basis-of-design product,” including make or model number or other designation, to establish the significant qualities related to type, function, dimension, in-service performance, physical properties, appearance, and other characteristics for purposes of evaluating comparable products of additional manufacturers named in the specifications.

### **3.13. USE OF SITE**

**3.13.3 ADD:** MSU BOZEMAN Vehicle Regulations state:

“All students, faculty, staff, and visitors must register any motor vehicle they park on the University campus, for any reason. A visitor is anyone not defined as student, staff or faculty.”

All Contractor and Contractor employees shall comply with Montana State University parking regulations. MSU parking permits can be purchased at the Huffman Building at Seventh Avenue and Kagy Boulevard. Contractor should call University Police at 994-2121 for permit information. Violators of MSU Bozeman Vehicle Regulations may be ticketed and towed.

Unless otherwise indicated on the drawings, all Contractor and Contractor employee vehicles on campus shall be parked in designated parking lots. If allowed on the drawings, vehicles to a maximum number stated, may be parked in project site areas designated and shall only be Contractor vehicles with company signs clearly visible. No personal vehicles shall be parked at the project site in any case. If a driver of a vehicle not allowed to be parked at the project site must unload equipment, tools, or materials, the vehicle must be immediately thereafter moved to a designated lot or leave campus. Vehicles parked in the project site, other than those allowed on the drawings, may be ticketed and towed.

Access to the project site shall be only by the route designated on the drawings. In cases where a different route must be used for a specific purpose, permission must be obtained from MSU Facilities Services. In no case will vehicles be used on the Centennial Mall paving. Access routes are for delivery of equipment, tools, and not for parking.

Site staging areas for materials and equipment if permitted, will be designated on the drawings if permitted. If not designated, staging is intended to be in the construction area boundaries. Staged materials and equipment must be secured on the ground surface or in trailers. Site staging areas shall be fenced.

**3.13.4 ADD:** The Contractor shall coordinate his operations with the Owner in order that the Owner will have maximum use of existing facilities surrounding the area of the Work, as agreed upon, at all times during normal working hours. Contractor further agrees to coordinate his operations so as to avoid interference with the Owner's normal operations to as great an extent as possible.

**3.13.5 ADD:** By acceptance of MSU Building Keys the Contractor agrees with the following: University keys are the property of Montana State University. Fabricating, duplicating or modifying University keys is prohibited. Doors must remain locked at all times. The use of these keys to allow unauthorized persons to enter the above areas is prohibited. Loss of any key must be reported immediately to the Director, Office of Facilities Services and University Police, if the loss of keys results in re-keying costs, these costs will be charged to the Contractor. **See attached Estimated Re-Keying Costs.**

**3.13.6 ADD:** The Montana Legislature decreed that the "right to breath smoke-free air has priority over the desire to smoke" (MCA 20-40-102). It is the policy of MSU to promote the health, wellness and safety of all employees, students, guests, visitors, and contractors while on campus. Therefore, the campus will be free of tobacco-use effective August 1, 2012. The use of tobacco (including cigarettes, cigars, pipes, smokeless tobacco and all other tobacco products) by students, faculty, staff, guests, visitors, and contractors is prohibited on all properties owned or leased by MSU.

Littering any university property, whether owned or leased, with the remains of tobacco products is prohibited.

All university employees, students, visitors, guests, and contractors are required to comply with this policy, which shall remain in effect at all times. Refusal to comply with this policy may be cause for disciplinary action in accordance with employee and student conduct policies. Refusal to comply with the policy by visitors, guests and contractors may be grounds for removal from campus. ([http://www2montana.edu/policy/smoking\\_facilities/](http://www2montana.edu/policy/smoking_facilities/))

**3.13.7 ADD:** The Contractor may use the University's toilet facilities only as directed by the Owner.

## **ARTICLE 4 – ADMINISTRATION OF THE CONSTRUCTION CONTRACT**

### **4.6. ARBITRATION**

**4.6.3 Insert** in the second line "the Eighteenth Judicial District, Gallatin County" in lieu of "First Judicial District, Lewis & Clark County."

**4.6.11 ADD:** In responding to a claim brought by a Contractor, the Owner shall have a minimum of forty-five (45) days in which to respond to a revised claim prior to the arbitration hearing.

## **ARTICLE 7 – CHANGES IN WORK**

### **7.2 CHANGE ORDERS**

**7.2.2.1 Insert** the word "maximum" before "5%" and insert the word "maximum" before "10%".

**7.2.2.4 ADD:** Total Change Order markup shall not exceed (cost of the work) x 1.15.

**7.2.3.1 Insert** at the beginning of the first sentence the word "Itemized".

**7.2.3.2 Insert** at the beginning of the first sentence the word "Itemized".

**7.2.3.3 Insert** at the beginning of the first sentence the word "Itemized".

**7.2.3.4 ADD:** The Contractor shall provide a complete description summarizing all work involved.

## **ARTICLE 8 - TIME**

### **8.1. DEFINITIONS**

**8.1.8.1 ADD:** The Owner will issue a written Notice to Proceed on satisfactory receipt of the signed Contract and all required bonds, insurance and other required submittals. Work commenced before receipt of the Notice to Proceed will be entirely at the Contractor's risk.

## **8.2. PROGRESS AND COMPLETION**

**8.2.5 ADD:** Completion of the work within the stated time and/or by the date stated on the Notice to Proceed is of the essence of this Contract and failure to complete, without approved time extension, may be considered default of the Contract. At the time for completion as stated on the Notice to Proceed or as extended by approved change order, if the work is not substantially complete, the Owner may notify the Contractor and the Contractor's surety company in writing of the recourse the Owner intends to take, within the Contract, to assess liquidated damages and /or cause the work to be completed.

## **8.3. DELAYS AND EXTENSIONS OF TIME**

**8.3.4 ADD:** By the act of signing the Contract, the Contractor signifies that he/she and all subcontractors can perform the work within the stated schedule and that subcontractors, manufacturers, suppliers, and deliverers are known to be able to support the schedule. Time extension may be granted for unforeseen conditions or events out of the Contractor's control causing delay in delivery of materials or causing delay in the Contractor's ability to perform the work within the Contract Documents. The Contractor is expected to take all possible measures and bear all reasonable costs in order to anticipate, control, counteract, and expedite such delay-causing conditions, including finding alternative sources of materials, equipment, shipping, and labor. Notification of any claim for schedule delay must be made in writing to the Owner within one week of the causing event or of first knowledge of a known delay causing condition with supporting documentation as required by the Owner. The Owner will respond in writing within one week to claims of delay. No claims of delay will be entertained after the date of completion as stated on the Notice to Proceed or as extended by previously approved delay claims.

## **ARTICLE 9 – PAYMENTS AND COMPLETION**

### **9.3. APPLICATIONS FOR PAYMENT**

**9.3.7.2.1. Insert** in the first line "Schedule of Values" in lieu of "Schedule of Amounts for Contract Payment".

**9.3.7.2.3 ADD:** Subcontractor's List: The Contractor shall list all subcontractors doing work in excess of \$5,000.

### **9.8. SUBSTANTIAL COMPLETION**

**9.8.4.1 ADD:** Prior to the inspection, the Contractor shall complete the final clean-up of the project site which, unless otherwise stated in the Contract Documents, shall consist of:

**9.8.4.1.1** Removal of all debris and waste. All construction debris and waste shall be removed from the campus grounds. Use of the University trash containers will not be permitted.

**9.8.4.1.2** Removal of all stains, smears, marks of any kind from surfaces including existing surfaces if said damage is the result of the work.

**9.8.4.1.3** Removal of all temporary structures and barricades.

### **9.10. FINAL COMPLETION AND FINAL PAYMENT**

**9.10.2.4 Insert** in the first line after the word "(Form 103)": "for contracts greater than or equal to \$25,000"

## **ARTICLE 10 – PROTECTIONS OF PERSONS AND PROPERTY**

### **10.1. SAFETY**

**10.1.2 Insert** in the second line before the word "safeguards": "and as approved by Owner,"

**10.1.2.1 ADD:** The Contractor recognizes that the Work will be conducted in and around buildings and areas that are occupied and will continue to function for the purposes of the University. The Contractor shall conduct a project safety meeting prior to the start of the Work, with the Owner's representative and all others that the Owner's representative deems necessary. The purpose of the meeting shall be to produce project specific rules and guidelines pertaining to but not restricted to: safety of persons in and around the area of the Work including type and location of fencing, guards, signage, etc.; closing of existing campus circulation routes and designation of alternate routes,

including creation of temporary routes of access as required; creation and location of temporary signage as required to maintain accessible routes for handicapped access to and around the site of the Work. The Contractor shall be solely responsible for implementing all required means and methods for site safety and security that may be agreed upon in this meeting.

**10.1.2.2 ADD:** Contractor shall notify Owner any time his operations will disrupt use of and access to existing accessible routes. Contractor is solely responsible for maintaining existing accessible routes in the area of the project with the exception of temporary interruptions lasting one day or less. Contractor is responsible for erecting signage identifying temporary re-routing of accessible routes. Such re-routing shall be coordinated with Owner in advance.

### **10.3. UTILITIES**

**10.3.1 ADD:** Underground Utilities: Buried utilities, including, but not limited to, electricity, gas, steam, air, water, telephone, sewer, irrigation, broadband coaxial computer cable, and fiber optic cables are very vulnerable and damage could result in loss of service. The telephone, broadband and fiber optic cables are especially sensitive and the slightest damage to these components will result in disruption of the operations of the campus.

**10.3.2 ADD:** "One Call" must be notified by phone and in writing at least 72 hours (3 business days) prior to digging to arrange and assist in the location of buried utilities in the field. (Dial 811). The Contractor shall mark the boundary of the work area. The boundary area shall be indicated with white paint and white flags. In winter, pink paint and flags will be accepted.

**10.3.3 ADD:** After buried utilities have been located, the Contractor shall be responsible for any utilities damaged while digging. Such responsibility shall include all necessary care including hand digging. Contractor's responsibility shall also include maintaining markings after initial locate. The area for such responsibility, unless otherwise indicated, shall extend 24 inches to either side of the marked center line of a buried utility line. In cases of multiple or overlapping utilities or inconclusive electronic locating signals, MSU Project Manager may specifically indicate a wider area for Contractor's responsibility.

**10.3.4 ADD:** The Contractor's responsibility shall include repair or replacement of damaged utilities. In the event of damage to the 15 KV electrical distribution system, the broadband or fiber optic cables, repair will consist of replacement from termination to termination. Facilities Services and the MSU Information Technology Center will verify repair and recertification. The Contractor will also be responsible for all costs associated with re-terminations and recertification.

**10.3.5 ADD:** Any buried utilities exposed by the operations of the Contractor shall be marked on the plans and adequately protected by the Contractor. If any buried utilities not located are exposed, the Contractor shall immediately contact Facilities Services at the numbers above. If, after exposing an unlocated buried utility, the Contractor continues digging without notifying Facilities Services and further damages the utility, the Contractor will be responsible.

**10.3.6 ADD:** Damage to irrigation systems during seasons of no irrigation that are not immediately and adequately repaired and tested will require the Contractor to return when the system is in service to complete the repair.

**10.3.7 ADD:** In the event of a planned interruption of any existing utility service, the Contractor shall make arrangements with Facilities Services at least 72 hours (3 business days) in advance. Shutdowns of the broadband or fiber optic cables will normally require 5 working days notice to Facilities Services and the Information Technology Center. The Contractor shall bear all costs associated with the interruptions and restorations of service.

**10.3.8 ADD:** The Owner allows the contractor to use the Owner's utilities (water, heat, electricity) services without charge for procedures necessary for the completion of the work.

## **ARTICLE 11 - INSURANCE AND BONDS**

### **11.4. COMMERCIAL GENERAL LIABILITY INSURANCE**

**11.4.1.3. Insert** in the first line after "State of Montana": ", Montana State University".

### **11.7. PERFORMANCE BOND AND LABOR & MATERIAL PAYMENT BOND (BOTH ARE REQUIRED ON THIS PROJECT)**

**11.7.1.** Insert in the first line at the beginning of the sentence "For contracts equal to or greater than \$25,000".

## **11.8. CANCELLATION**

**11.8 ADD** All Certificates shall contain a provision that coverage provided by the policies will not be cancelled without at least thirty (30) days prior notice to the Owner.

## **ARTICLE 13 – MISCELLANEOUS PROVISIONS**

### **13.1. GOVERNING LAW**

**13.1.1. Insert** in the second line “The Eighteenth Judicial District, Gallatin County” in lieu of “First Judicial District, Lewis and Clark County”.

### **13.9 EMERGENCY AND PUBLIC SAFETY**

Montana State University has an Emergency and Public Safety Alert System that warns the campus community in the event of an emergency or public safety event. Because contractors, consultants, and vendors are considered members of the campus community when working on campus, they must be familiar with the alert system and understand when the system is used. Montana State University requires all contractors, consultants, vendors, and their employees working on or entering the MSU-Bozeman campus to register for the Emergency and Public Safety Alert System. The link to register is: <http://www.montana.edu/msualert/>.

**END OF SUPPLEMENTARY GENERAL CONDITIONS**



## **Cost Estimate to Re-key Buildings**

Access to campus buildings is controlled for safety and security reasons. As a key holder the contractor is responsible for following processes associated with maintaining the integrity of our access control program. If a key is lost the contractor is liable for costs associated with ensuring access control is maintained. In some cases that requires re-keying an entire building or key sequence. Cost can range from \$2,000 to over \$200,000 depending on building and key hierarchy.

## SECTION 011000 SUMMARY

### 1.1 PART 1 - GENERAL

- A. Related Documents
  - 1. Drawings and general provisions of Contract, including General Conditions, Supplemental Conditions and other Division 1 Specification Sections, apply to this Section.
- B. Project Description
  - 1. Reference "Design Manual" attached.
- C. Site Information
  - 1. Reference "Design Manual" attached.
- D. Contracts
  - 1. Contracts shall be under one General Contract and shall include, but not be limited to, all labor, materials, and supervision necessary to furnish and install the Work.
- E. Work Sequence
  - 1. The work will be conducted in a phased manner approved by the Owner to provide the least possible interference to the activities of the Owner's personnel and activities.
  - 2. The Contractor will have access to all affected buildings from the date of receipt of the contract.
- F. Contractor Use of Premises
  - 1. Work on this contract is expected to be done during regular working hours Monday through Friday. Any variation from this will require prior approval of the Consultant and Owner.
  - 2. All work must be coordinated with MSU at all times and MSU must be informed about any work impacting campus operations 72 hours or 3 working days in advance of work being conducted and shall require MSU approval.
  - 3. General: Limit use of the premises to construction activities in areas indicated; allow for Owner/MSU occupancy and use by the public. Confine operations to areas within contract limits indicated. Portions of the site beyond areas in which construction operations are indicated are not to be disturbed.
  - 4. Contractor shall conduct all his work in such a manner as to minimize the inconvenience and disruption of MSU's daily schedule.
  - 5. Confine operations at the site to the areas permitted under the Contract. Portions of the site beyond areas on which work is indicated are not to be disturbed. Conform to site rules and regulations affecting the work while engaged in project construction.
  - 6. Do not unreasonably encumber the site with materials or equipment. Confine stockpiling of materials to the areas designated on the drawings. If additional storage is necessary, obtain and pay for such storage off-site.

7. Contractor shall establish a staging area for storage of materials and equipment.
8. The Contractor is to coordinate with MSU for the location of the job site trailer office.
9. Keep driveways and entrances serving the premises clear and available to MSU and MSU's employees, staff and visitors at all times, unless otherwise agreed by MSU. Do not use these areas for parking or storage of materials. Schedule deliveries to minimize space and time requirements for storage of materials and equipment on site.

G. Parking and Site Access

**(See also Supplemental Conditions of the Contract for Construction.)**

1. MSU Bozeman Vehicle Regulations state: "All students, faculty, staff, and visitors must register any motor vehicle they park on the University campus, for any reason. A visitor is anyone not defined as student, staff or faculty."
2. All Contractor and Contractor employees shall comply with Montana State University parking regulations. MSU parking permits can be purchased at the University Police Office located in the Huffman Building at Seventh Avenue and Kagy Boulevard. Violators of MSU Bozeman Vehicle Regulations may be ticketed and towed.
3. A maximum of three (3) Contractor Permits (or as agreed with MSU) will be made available to the Contractor for parking of essential vehicles within the designated parking lot (as designated on the Cover Sheet of the Contract Documents). Essential vehicles are vehicles used for delivery of equipment and tools required to be parked in close proximity to the construction area. All allowed vehicles only to be parked on hard surfaced areas within the Staging Area. All other Contractor and Contractor employee vehicles on campus shall be parked in designated parking lots to be agreed with MSU. No personal vehicles shall be parked at the project site in any event. If a driver of a vehicle not allowed to be parked at the project site must unload equipment, tools, or materials, the vehicle must be immediately thereafter move to a designated lot or leave campus.
4. Access and egress to and from the project site shall be coordinated with the owner. In cases where a different route must be used for a specific purpose, permission must be obtained from MSU. Access routes are for delivery of equipment, tools, and materials and not for parking.
5. The site Staging Areas for materials and equipment are designated on the Cover Sheet of the Contract Documents. Staged materials and equipment must be secured on the ground surface or in trailers. Site staging areas shall be fenced in accordance with the Contract Documents. Vehicles in addition to those allowed to be parked may not be used for staging of equipment, tools, or materials.

H. Owner Occupancy

1. Full Owner/MSU Occupancy: The Owner/MSU will occupy the site during the entire construction period. Cooperate with MSU during construction operations to minimize conflicts and facilitate MSU usage. Perform the work so as not to interfere with MSU's operations.

I. Safety Requirements

1. General: The safety measures required by the Contract Documents are not meant to be inclusive. The Contractor shall be solely responsible for safety on a 24-hours-per-day, 7 days-per-week basis and shall take whatever additional measures are necessary to insure the health and safety of the buildings' occupants, or pedestrians at or near the construction site and access routes and of all other persons in all areas affected by the Contractor's activities. Prior to the start of construction, the Contractor is to submit to the Consultant, a detailed written plan specifying the safety procedures that will be followed. Include (but not by way of limitation) the following: Verbiage, size and locations of warning signs; construction sequence as related to safety; use of barricades (type and location); employee policies as related to safety; and delivery of materials as related to safety. Revise the safety plan as required during construction and resubmit to the Owner.
2. All application, material handling, and associated equipment shall conform to and be operated in conformance with OSHA safety requirements.
3. Comply with Federal, State, local, and the Owner's fire, health and safety requirements.
4. Advise MSU whenever work is expected to be hazardous or inconvenient (including objectionable odors) to MSU's employees, students, visitors or the building occupants.
5. Construction materials or equipment shall be placed so as not to endanger the work or prevent free access to all emergency devices or utility disconnects.
6. Maintain the proper rated fire extinguishers within easy access where power tools, sanding or other equipment is being used.
7. The Contractor shall erect and maintain, as required by law, conditions and progress of the work, warning signs, barricades and other reasonable safeguards for safety and protection.
8. **Emergency and Public Safety Alert System:**  
Montana State University has an Emergency and Public Safety Alert System that warns the campus community in the event of an emergency or public safety event. Because contractors, consultants, and vendors are considered members of the campus community when working on campus, they must be familiar with the alert system and understand when the system is used. Montana State University requires all contractors, consultants, vendors, and their employees working on or entering the MSU-Bozeman campus to register for the Emergency and Public Safety Alert System. The link to register is:  
<http://www.montana.edu/msualert/>

J. Existing Premises Condition

1. The Contractor is responsible for adequately documenting in photos the existing condition of the premises, to include external road surfaces, curbing and landscaped areas, specifically the cleanliness of areas. Any damage to the premises which is found after construction and is not so documented will be the responsibility of the Contractor to repair or replace.

K. Discrepancies in the Documents

1. The Contractor shall bring any discrepancies between any portions of the drawings and specifications to the attention of the Owner and the Consultant in writing. The Owner and Consultant shall review the discrepancy and clarify the intent desired in the Contract Documents. Unless specifically directed otherwise, the Contractor shall be obligated to provide the greater quantity or quality without any change in contract sum or time.

END OF SECTION 011000

# CAMPUS ELEVATOR COMMUNICATIONS INSTALLATION

MONTANA STATE UNIVERSITY - BOZEMAN  
CAMPUS-WIDE

OWNER:  
MSU - CAMPUS PLANNING,  
DESIGN & CONSTRUCTION  
P.O. BOX 172760  
BOZEMAN, MT 59717

CONSULTANT:  
CUSHING TERRELL  
316 N. LAST CHANCE GULCH  
HELENA, MT 59601

PPA# 21-0104

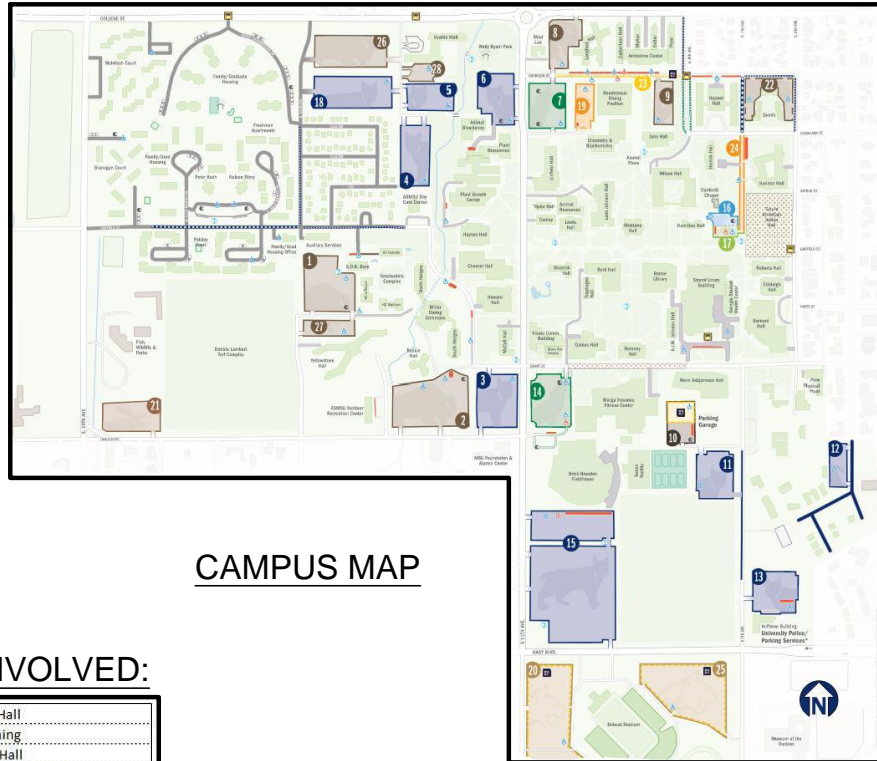

CAMPUS MAP

## LIST OF BUILDINGS INVOLVED:

AJM Johnson Hall	Madison Hall
American Indian Hall	Miller Dining
Animal Bioscience Building	Montana Hall
Barnard Hall	Museum of the Rockies
Black Box Theater	Nelson Story Tower Apartments
Bobcat Athletic Complex	Nopper 920
Bobcat Stadium	Norm Asbjornson Hall
Brick Breeden Fieldhouse	North Hedges
Cheever Hall	Parking Garage
Chemistry & Biochemistry Building	Peter Koch Tower
Cobleigh Hall	Plant Bioscience Building
Cooley Labs	Plant Growth Center
Culbertson Hall	Power Plant
Gaines Hall	Reid Hall
Gallatin Hall	Rendezvous Dining
Hamilton Hall	Renne Library
Hannon Hall	Roberts Hall
Hapner Hall	Romney Hall
Haynes Hall	Roskie Hall
Health Sciences Building	Roskie Hall
Hyalite Hall	Shroyer Gym
Jake Jabs College of Business	South Hedges
Jefferson Hall	Student Union Building
Johnstone Center	Swingle Health Services
Johnstone Center	Traphagen Hall
Langford Hall	Visual Communications Building
Leon Johnson Hall	Wilson Hall
Linfield Hall	Yellowstone Hall



MSU-CPDC

MONTANA STATE  
UNIVERSITY  
BOZEMAN, MONTANA  
PHONE: 406.994.5413  
FAX: 406.994.5665

CAMPUS ELEVATOR  
COMMUNICATIONS  
INSTALLATION  
MSU BOZEMAN CAMPUS

**Cushing  
Terrell**

HELENA, MT  
p 406.495.9400  
f 406.495.9403

DRAWN BY: CUSHING TERRELL

REVIEWED BY:

REV.	DESCRIPTION	DATE
△	-	-

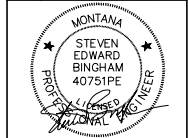

PPA#21-0104

-

Consultant#:  
MSU\_ELEVATOR

SHEET TITLE  
COVER SHEET

SHEET

CS-1

DATE  
10-31-22

October 31, 2022



Steve Bingham, P.E.  
Cushing Terrell  
316 N. Last Chance Gulch  
Helena, MT 59601

**Project Information:**

Montana State University – Bozeman (MSU) is seeking proposals to provide equipment and installation labor associated with upgrading the communications links on selected campus building elevator cars in accordance with requirements of the International Building Code, specific to the capability of 2-way communications between each elevator car and a constantly attended location.

The successful bidding contractor will be responsible for procuring equipment, installing the systems in accordance with manufacturer’s listings and code requirements and demonstrating operation to the satisfaction of the local AHJ.

Upon project completion, each building specifically mentioned in this project narrative shall be provided with the means for 2-way communications between the elevator car and a constantly attended monitoring station utilizing a cellular-based communications system as specified herein.

The Owner will be responsible for contracting remote monitoring services with a provider of their choice. The Owner’s preferred cellular provider is AT&T and as such all cellular communication devices shall be compatible with this provider’s network.

A comprehensive list of buildings associated with this project scope of work is provided in “Exhibit A”

**Existing Conditions:**

Approximately 40 buildings campus-wide, consisting of a total of almost 60 elevators, were surveyed for current car communications abilities. A majority of these elevators were witnessed to have current equipment in place to allow communications between the car and its associated controller. These same units are connected to the campus IP-based phone system allowing for a communications link but fails to meet all requirements of code-compliant “elevator communications”. Some of the elevators surveyed appeared to have only one-way

communications link and finally, a portion of the elevators surveyed had no communications link in place at all.

Elevators which had existing communications links, employed various means of interface within the car. Some cars had the factory emergency call button and speaker located behind the interior panel connected directly to the phone system utilizing one pair a standard 4-pair telephone cable which provided the connection between each car and terminated at its respective elevator controller box. The communications link from that point is extended to the campus phone system but the exact nature of that cabling connection was not determined. The majority of the cars had existing aftermarket call boxes installed either surface or inside the phone cabinet where available. These boxes were again, connected to their respective controllers utilizing a single pair of a 4-pair telephone cable.

### **Project Scope:**

The intent of this project is for all elevators listed in this project to have code-compliant, 2-way elevator communications and the ability to automatically connect to a 24-hour attended monitoring station of Owner's Choice.

Each elevator car will ultimately be provided with a dedicated cellular gateway communication system allowing a passenger in the elevator to establish 2-way communications over MSU's preferred cellular provider network in the event of an emergency. MSU's preferred cellular provider is AT&T®.

There are several scenarios where a single building may have multiple elevators in which case the intent is to combine each elevator's communication link to utilize a single cellular gateway for communicating. This will reduce the total number of SIM cards and their associated subscriber services which the Owner is responsible to pay.

Each elevator falls into one of 4 different standard installation scenarios as follows;

#### **Scenario #1 (reference drawing "DET-1" attached):**

1. Contractor will field verify the existing elevator call box and associated cabling to the controller is functional in a basic sense. Reference Fig. 1-1 and Fig. 1-2.
2. Contractor will intercept communications wiring inside the elevator controller and extend the circuit to the location of the new cellular gateway. Reference Fig. 1-3.



**Scenario #1 (Cont'd):**

3. Contractor shall provide and install a cellular gateway inside the elevator machine room in close vicinity to the controller. Permanently attach the equipment to the wall and route cabling in accordance with applicable codes in a neat workmanship manner and reasonably protected from damage.
4. Contractor shall provide and connect an uninterruptible power supply (UPS) unit to provide power and backup power to the new equipment. Contractor shall field verify the presence of 120VAC receptacle in the vicinity and utilize a plug and cord for connection to power. If field verification determines there is no existing receptacle available the contractor shall be responsible for providing a new receptacle by locating and extending an existing 120VAC circuit to the desired installation location and mounting as required. The UPS unit shall meet all requirements dictated by the equipment manufacturer. UPS may be wall mounted or floor mounted. All cabling between UPS and the cellular gateway shall be run neatly and secured properly.
5. Contractor shall provide and connect a cellular antenna recommended and compatible with the equipment to ensure proper signal levels are maintained. If warranted, the contractor shall be responsible for providing and installing additional cabling to remote mount the antenna on the exterior of the building in an inconspicuous location but conducive to providing adequate signal levels for communications. Field coordination will be required and approval from Owner shall be obtained prior to installation. All associated cabling shall be run neatly and concealed from sight to the greatest extent possible. Contractor shall be responsible for providing any surface mounted raceway that may be required to facilitate. Most elevator machine rooms are located in the basement and it is anticipated that a remote antenna will be required in most instances due to the location of base equipment and the difficulty of receiving adequate signal at that location on a normal basis. Field verification of signal strength shall be required and be documented for final acceptance.
6. Contractor shall, upon completion of installation, coordinate with the Owner to program the system to automatically call the remote attended station selected by the Owner. The contractor shall also test each

**Scenario #1 (Cont'd):**

communications system in the presence of and to the approval of a licensed and certified elevator inspector prior to final acceptance. Existing communications links shall remain operational until final cut-over is ready. Elevators shall be temporarily disabled from use during communications interruption. Contractor shall coordinate with building operations personnel to ensure elevator passengers are aware of the impairment and unable to board the car while it is disabled.



Fig. 1-1

Example of existing, factory installed elevator call box.

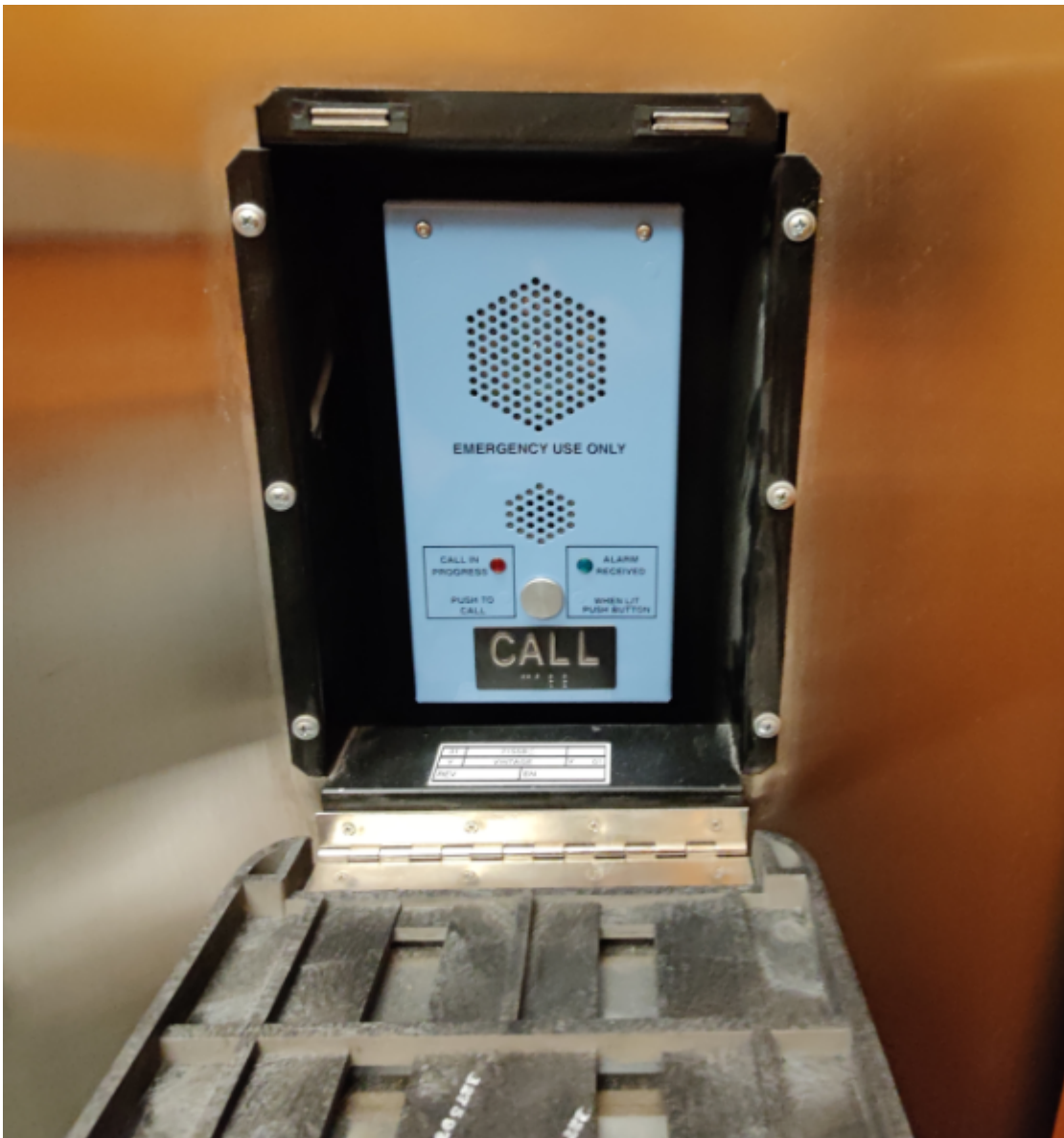

Fig 1-2

Example of typical existing aftermarket elevator cab call box.

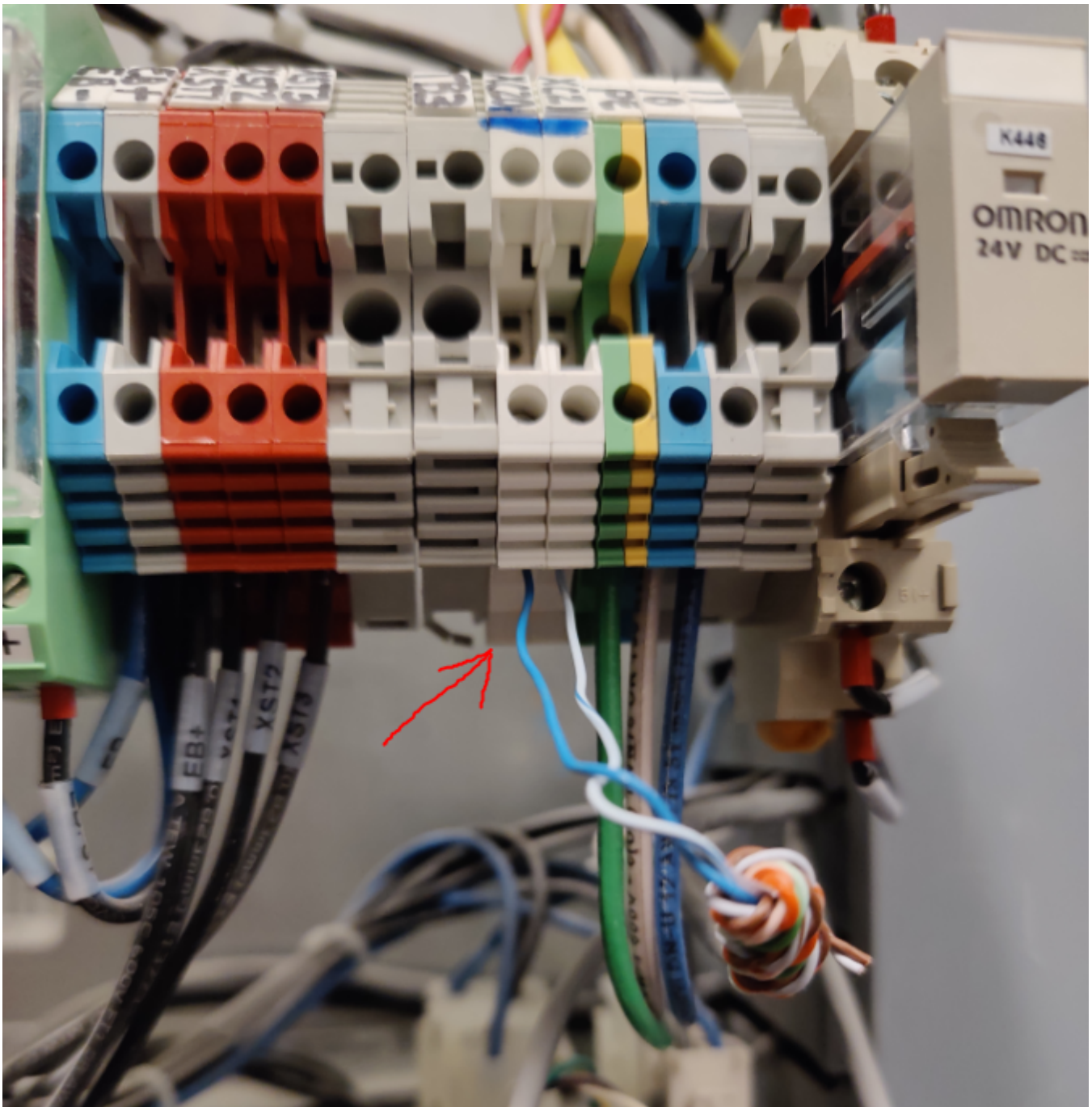

Fig. 1-3

Example of typical elevator communications wiring termination inside controller.



Fig. 1-4

Example of typical power availability in elevator machine room. Varies from building to building. Field verification required.

**Scenario #2** (reference drawing "DET-2" attached):

1. Contractor will field verify the existing elevator communications cabling to the controller is functional in a basic sense. Reference Fig. 1-3.
2. Existing factory elevator car call buttons shall be removed or covered permanently to avoid misleading or confusing a passenger in emergency communications procedure.
3. Contractor shall provide a new call station and mount it neatly in the elevator car utilizing a surface mount device. Mount directly to the face of the car interior panel or inside the factory phone box if available. Reference Fig. 1-2.
4. Contractor shall disconnect existing call buttons and reconnect existing wiring to the new call station.
5. Contractor will intercept existing communications wiring inside the elevator controller and extend the circuit to the location of the new cellular gateway.
6. Contractor shall provide and install a cellular gateway inside the elevator machine room in close proximity to the controller. Permanently attach the equipment to the wall and route cabling in accordance with applicable codes in a neat workmanship manner and reasonably protected from damage.
7. Contractor shall provide and connect an uninterruptible power supply (UPS) unit to provide power and backup power to the new equipment. Contractor shall field verify the presence of 120VAC receptacle in the vicinity and utilize a plug and cord for connection to power. If field verification determines there is no existing receptacle available, the contractor shall be responsible for providing a new receptacle by locating and extending an existing 120VAC circuit to the desired installation location and mounting as required. The UPS unit shall meet all requirements dictated by the equipment manufacturer. UPS may be wall mounted or floor mounted. All cabling between UPS and the cellular gateway shall be run neatly and secured properly.
8. Contractor shall provide and connect a cellular antenna recommended and compatible with the equipment to ensure proper signal levels are maintained. If warranted, the contractor shall be responsible for providing and installing additional cabling to remote mount the antenna on the exterior of the building in an inconspicuous location but conducive to

**Scenario #2(Cont'd):**

9. providing adequate signal levels for communications. Field coordination will be required and approval from Owner shall be obtained prior to installation. All associated cabling shall be run neatly and concealed from sight to the greatest extent possible. Contractor shall be responsible for providing any surface mounted raceway that may be required to facilitate. Most elevator machine rooms are located in the basement and it is anticipated that a remote antenna will be required in most instances due to the location of base equipment and the difficulty of receiving adequate signal at that location on a normal basis. Field verification of signal strength shall be required and be documented for final acceptance.
10. Contractor shall, upon completion of installation, coordinate with the Owner to program the system to automatically call the remote attended station selected by the Owner. The contractor shall also test each communications system in the presence of and to the approval of a licensed and certified elevator inspector prior to final acceptance. Existing communications links shall remain operational until final cut-over is ready. Elevators shall be temporarily disabled from use during communications interruption. Contractor shall coordinate with building operations personnel to ensure elevator passengers are aware of the impairment and unable to board the car while it is disabled.

**Scenario #3 (reference drawing "DET-3" attached):**

1. Contractor will field verify existing elevator communications equipment and associated cabling are not available.
2. Contractor shall provide and install new 4-pair (20-22 ga) jacketed cable between elevator car and controller located in the machine room. Route new cable the same as the existing elevator traveler cable assembly and ensure elevator operation is not affected and that the new cable is not in jeopardy of damage by the car and its travel path.
3. Contractor shall provide a new call station and mount it neatly in the elevator car utilizing a surface mount device. Mount directly to the face of the car interior panel or inside the factory phone box if available.  
Reference Fig. 1-2.

**Scenario #3 (Cont'd):**

4. Contractor will extend the new communications wiring to the location of the new cellular gateway.
5. Contractor shall provide and install a cellular gateway inside the elevator machine room in close proximity to the controller. Permanently attach the equipment to the wall and route cabling in accordance with applicable codes in a neat workmanship manner and reasonably protected from damage.
6. Contractor shall provide and connect an uninterruptible power supply (UPS) unit to provide power and backup power to the new equipment. Contractor shall field verify the presence of 120VAC receptacle in the vicinity and utilize a plug and cord for connection to power. If field verification determines there is no existing receptacle available, the contractor shall be responsible for providing a new receptacle by locating and extending an existing 120VAC circuit to the desired installation location and mounting as required. The UPS unit shall meet all requirements dictated by the equipment manufacturer. UPS may be wall mounted or floor mounted. All cabling between UPS and the cellular gateway shall be run neatly and secured properly.
7. Contractor shall provide and connect a cellular antenna recommended and compatible with the equipment to ensure proper signal levels are maintained. If warranted, the contractor shall be responsible for providing and installing additional cabling to remote mount the antenna on the exterior of the building in an inconspicuous location but conducive to providing adequate signal levels for communications. Field coordination will be required and approval from Owner shall be obtained prior to installation. All associated cabling shall be run neatly and concealed from sight to the greatest extent possible. Contractor shall be responsible for providing any surface mounted raceway that may be required to facilitate. Most elevator machine rooms are located in the basement and it is anticipated that a remote antenna will be required in most instances due to the location of base equipment and the difficulty of receiving adequate signal at that location on a normal basis. Field verification of signal strength shall be required and be documented for final acceptance.
8. Contractor shall, upon completion of installation, coordinate with the Owner to program the system to automatically call the remote attended



**Scenario #3 (Cont'd):**

station selected by the Owner. The contractor shall also test each communications system in the presence of and to the approval of a licensed and certified elevator inspector prior to final acceptance. Existing communications links shall remain operational until final cut-over is ready.

9. Elevators shall be temporarily disabled from use during communications interruption. Contractor shall coordinate with building operations personnel to ensure elevator passengers are aware of the impairment and unable to board the car while it is disabled.

**Scenario #4 (reference drawing "DET-4" attached):**

1. Contractor will field verify existing elevator communications equipment (call station) and associated cabling are available and in working order.
2. Contractor shall provide and install a "master station" at one of the elevator controllers and provide connection from remote elevator call stations. This serves to consolidate multiple call stations (multiple elevators) into one central receiver and allow for a single cellular communicator to provide the communications interface. Provide and install a surface mounted unit (cabinet) in an accessible area and near the cellular gateway. Reference DET-6.
  - a. There are a few instances where multiple elevators in a single building are separated by distances which would require extensive cable routing increasing costs excessively. In this type of situation, the contractor has the option to provide a cellular communicator for each elevator controller to reduce cable installation costs associated with interconnection of the individual elevator call stations. Contractor shall clearly indicate this in their bid.
3. Contractor shall provide and install a cellular gateway inside the elevator machine room containing the "master station" and in close vicinity to the master station. Permanently attach the equipment to the wall and route cabling in accordance with applicable codes in a neat workmanship manner and reasonably protected from damage.
4. Contractor shall provide and connect an uninterruptible power supply (UPS) unit to provide power and backup power to the new equipment. Contractor shall field verify the presence of 120VAC receptacle in the

**Scenario #4 (Cont'd):**

vicinity and utilize a plug and cord for connection to power. If field verification determines there is no existing receptacle available the contractor shall be responsible for providing a new receptacle by locating and extending an existing 120VAC circuit to the desired installation location and mounting as required. The UPS unit shall meet all requirements dictated by the equipment manufacturer. UPS may be wall mounted or floor mounted. All cabling between UPS and the cellular gateway shall be run neatly and secured properly.

5. Contractor shall provide and connect a cellular antenna recommended and compatible with the equipment to ensure proper signal levels are maintained. If warranted, the contractor shall be responsible for providing and installing additional cabling to remote mount the antenna on the exterior of the building in an inconspicuous location but conducive to providing adequate signal levels for communications. Field coordination will be required and approval from Owner shall be obtained prior to installation. All associated cabling shall be run neatly and concealed from sight to the greatest extent possible. Contractor shall be responsible for providing any surface mounted raceway that may be required to facilitate. Most elevator machine rooms are located in the basement and it is anticipated that a remote antenna will be required in most instances due to the location of base equipment and the difficulty of receiving adequate signal at that location on a normal basis. Field verification of signal strength shall be required and be documented for final acceptance.
6. Contractor shall, upon completion of installation, coordinate with the Owner to program the system to automatically call the remote attended station selected by the Owner. The contractor shall also test each communications system in the presence of and to the approval of a licensed and certified elevator inspector prior to final acceptance. Existing communications links shall remain operational until final cut-over is ready.
7. Elevators shall be temporarily disabled from use during communications interruption. Contractor shall coordinate with building operations personnel to ensure elevator passengers are aware of the impairment and unable to board the car while it is disabled.

**Project Execution:**

1. All work shall be performed by licensed and certified personnel.
2. All work shall be coordinated with MSU – PDC (Planning, Design & Construction) for each building.
3. All cabling shall be installed in a clean and neat method either above accessible ceilings or in surface raceway matching wall finish as closely as possible.
4. Equipment mounting locations shall be approved by MSU – PDC prior to installation. I.e. cellular gateways, UPS and exterior antennas.
5. Elevators determined to have no existing communications in place shall be prioritized above other elevators when coordinating construction schedule. Reference "Exhibit A" for prioritization. Those with priority designation "High" shall be installed before those designated as "Low".
6. Reference equipment specifications. (Exhibit B)

## Exhibit A – List of affected buildings.

Bldg Name	Detail Ref.	Comments	Priority
AJM Johnson Hall	-1, -5		Low
American Indian Hall	-1, -5		Low
Animal Bioscience Building	-1, -5		Low
Barnard Hall (x2)	-4, -6	Existing elevator call boxes; Will need master station for combining.	Low
Black Box Theater	-1, -5		Low
Bobcat Stadium (x2)	-1, -5		Low
Brick Breeden Fieldhouse (x3)	-4, -6	Existing elevator call boxes; Will need master station for combining.	Low
Cheever Hall	-1, -5		Low
Chemistry & Biochemistry Building	-1, -5		Low
Cobleigh Hall (x2)	-4, -6	Existing elevator call boxes; Will need master station for combining.	Low
Cooley Labs	-2, -5	Existing elevator call boxes do not appear to be compatible with new system.	Low
Gaines Hall	-2, -5	Existing elevator call boxes do not appear to be compatible with new system.	Low
Gallatin Hall	-1, -5		Low
Hamilton Hall	-1, -5		Low
Hannon Hall (x2)	-1, -3, -6	One elevator has existing comm., one does not; will need master station to combine.	Med
Hapner Hall (x3)	-3, -4, -6	No existing comms; Will need master station and prioritization.	High
Haynes Hall	-1, -5		Low
Health Sciences Building	-1, -5		Low
Jake Jabs College of Business	-1, -5		Low
Jefferson Hall	-1, -5		Low
Johnstone Center - Pryor	-3, -5	No existing comms; High priority.	High
Johnstone Center - Colter	-3, -5	No existing comms; High priority.	High
Johnstone Center - Culbertson	-3, -5	No existing comms; High priority.	High
Johnstone Center - Mullan	-3, -5	No existing comms; High priority.	High
Langford Hall	-3, -5	No existing comms; High priority.	High
Leon Johnson Hall (x3)	-4, -6	Existing elevator call boxes; Will need master station for combining.	Low
Linfield Hall	-1, -5		Low
Madison Hall	-1, -5		Low
Miller Dining (x2)	-1, -4, -6	One elevator has existing call box, one does not; Will need master station to combine. High Priority.	Med

## Exhibit A (Cont'd)

Bldg Name	Detail Ref.	Comments	Priority
Montana Hall	-1, -5		Low
Museum of the Rockies	-1, -5		Low
Nopper 920	-1, -5		Low
Norm Asbjornson Hall (x2)	-4, -6	Existing elevator call boxes; Will need master station for combining.	Low
North Hedges (x2)	-4, -6	Existing elevator call boxes; Will need master station for combining.	Low
Parking Garage	-1, -5		Low
Plant Bioscience Building	-1, -5		Low
Plant Growth Center	-1, -5		Low
Power Plant	-3, -5	Did not verify this building; Anticipate no existing communications and will require new cabling and equipment.	High
Reid Hall	-1, -5	Possible future elevator replacement.	Low
Rendezvous Dining (x2)	-1, -5	Existing elevator call boxes; Will need master station for combining.	Low
Renne Library (x3)	-4, -6	Two elevators have existing call boxes, one does not; Old freight elevator paddlocked shut and excluded from scope; High priority.	Med
Roskie Hall (x3)	-3, -4, -6	Two passenger elevators have existing call boxes, freight elevator does not. Will need master station to combine.	Med
Shroyer Gym	??	No information available; Did not field verify and excluded from scope.	
South Hedges (x2)	-4, -6	Existing elevator call boxes; Will need master station for combining.	Low
Student Union Building (x6)	-3, -4, -6	Only one elevator has existing call box, five will need new; Will require 10-station master; Consider separate cell dialers to avoid extensive cable runs and installation costs.	High
Swingle Health Services	-3, -5	No existing comms; High priority.	High
Traphagen Hall	-1, -5		Low
Visual Communications Building	-1, -5		Low
Wilson Hall	-1, -5		Low
Yellowstone Hall (x2)	-4, -6		Low

## Exhibit B – Equipment Specifications

### Division 28 Specifications

#### 28 4600 Elevator Two-Way Communication System

- *Basis of Design: Rath Communications SmartRescue Base Station, Call Boxes, Uninterruptible Power Supply and Cellular Gateway communicator.*

#### Part 1 - General

##### 1.0 Summary

###### 1.1 Basis-of-Design: Rath Communications

1.1.1 Base Station: Model 2500-205B

1.1.2 Call Box: Model 2100-956SR

1.1.3 Cellular Gateway: Model 2100-LTEGSM4-2 (AT&T)

1.1.4 UPS: RP7700104

1.2 The Base Station is to be located in an elevator machine room or as determined by local Authority Having Jurisdiction. Call Boxes are to be located in all elevator cars.

1.3 The Base Station must be capable of handling a minimum of 5 Call Boxes. Visual indicators on the Base Station allow rescue personnel to know which Call Box needs assistance. The Base Station must allow rescue personnel to speak to all Call Boxes or individual Call Boxes.

1.4 The emergency communication hardware shall comply with the Americans with Disabilities Act (ADA). The Call Box shall have the ability to be programmed with up to 5 emergency phone numbers. Upon activation of the emergency push button, a call will be automatically placed to the Base Station. If no one answers at the Base Station, the Call Box must dial a secondary location outside the building to activate two-way off-site person to person voice communication via cellular device.

##### 2.0 Submittals

2.1 Submit product data sheets. Include operation manuals.

2.2 Wiring or shop diagrams detailing wiring schematics, cabling.

##### 3.0 Construction

3.1 The Base Station (models 2500) must have a Stainless Steel or powder coated steel housing, red coil cord emergency handset, be 24vdc or 120vac powered, and include a rechargeable battery to maintain backup power for a minimum of 4 hours of talk time.

- 3.2 The Call Boxes (models 2100) must be in full compliance with ADA requirements. Call Boxes require a hands-free speakerphone with an LED to indicate status of call.
- 3.3 The Call Boxes must allow the programming in of a specific location message of the Call Box. This allows rescue personnel to know the location of the activated Call Box.
- 3.4 The Call Boxes are to be located no higher than 48" front reach, or 54" side reach to the center of the push button above ground level to ensure conformance with the ADA requirements.
- 3.5 The Area of Refuge Call Boxes must have a Braille face plate to ensure conformance with the ADA requirements.
- 3.6 The Base Station must provide an audible and visual indicator that a Call Box has been activated.
- 3.7 The 24vdc Power Supply part # 2500-PWR24U must be capable of supplying power to a minimum of 10 Call Boxes and the Base Station.

#### 4.0 Mounting

- 4.1 The Base Station is to be mounted on a wall, surface, or flush mounted.
- 4.2 Call Boxes are to be wall, surface, or flush mounted.

#### 5.0 Electrical

- 5.1 Call Boxes and Base Station are to be powered by RATH® 24vdc Power Supply part # 2500-PWR24U. Base Station to have option of 120vac power. Wiring shall be RATH® Custom Power Cable (part # RP7500094P).
- 5.2 Wiring from the Base Station to the Call Boxes shall be RATH® Custom Communication Cable (part # RP7500094). If CI 2 hour fire-rated cable is required, use RATH® Communication Cable part # RP6600300M.
- 5.3 Call Boxes must have built-in battery backup and include a rechargeable battery to maintain backup power for a minimum of 4 hours of talk time. If Call Boxes require protective covers per local municipal codes, use RATH® 2100-XXXSSRC2.
- 5.4 Base Station must have a built-in battery backup and include a rechargeable battery to maintain backup power for a minimum of 4 hours of talk time.
- 5.5 System shall be in compliance with all state and local electrical codes.

#### 6.0 Communications

- 6.1 The Call Boxes shall be an ADA compliant and vandal resistant speakerphone.
- 6.2 The Call Boxes shall be hands-free and be a push-button-once to talk system. Once the button has been pushed, the Call Box will call the Base Station. If no answer at the Base Station, it will automatically call pre-programmed emergency numbers. The Call Box must be capable of being programmed with up to 5 emergency numbers.

- 6.3 Call Box shall have location message capability. Call Box must have a minimum 18 second recordable message capability, programmable to play 1 or 2 times. Call Box shall notify called party of the location of the call upon being received at the emergency dispatch center.
- 6.4 Call Box shall be capable of allowing the called party to replay the location message if necessary to ensure an understanding of the caller location.
- 6.5 If system is not attended 24 hours a day, the Call Box must dial a secondary location outside the building to activate two-way off-site person to person voice communications.
- 6.6 Once call has been made (button pushed), the call can only be terminated by the called party.
- 6.7 Call Box must have a red LED that will light up upon push of the button. The light shall be a solid color when the Call Box is activated and will flash when call has been answered.
- 6.8 The Call Box must be capable of being programmed and re-programmed on-site and remotely.
- 6.9 Standard Call Box features:
  - 6.9.1 Five number programming.
  - 6.9.2 Operating temperature of between -40°F to +150°F (-40° to + 65° C).
  - 6.9.3 Programmable passwords.
  - 6.9.4 On-site or remote programmable.
  - 6.9.5 EEPROM memory to protect programming.
- 7.0 Graphics
  - 7.1.1.1 Base Station must include wording identifying the location of each Call Box and light an LED when a particular Call Box has been activated.
  - 7.1.1.2 Call Box wording must include "Emergency Phone", International Phone Symbol, and raised Braille lettering.
- 8.0 Cabling
  - 8.1 Cabling for two-way communication system shall meet the applicable requirements for pathway survivability. Cabling installation shall consist of one or more of the following:
    - 8.1.1 2 hour fire-rated circuit integrity (CI) cable – RATH® Part # RP6600300M (for a UL Listed option use part # RPP66010002).
    - 8.1.2 2 hour fire-rated cable system.
    - 8.1.3 2 hour fire-rated enclosure or protected area.
- 9.0 Warranty
  - 9.1 The Base Station and Call Boxes shall be warranted for a period of two years.



10.0 Manufacturer

10.1 Basis of design equipment manufacturer:

RATH® Communications

N56 W24720 North Corporate Circle

Sussex, WI 53089

800-451-1460

Website: [www.rathcommunications.com](http://www.rathcommunications.com)

REV.	DESCRIPTION	DATE
△	-	-

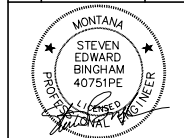

PPA#21-0104

-

Consultant#:  
MSU\_ELEVATOR

**SHEET TITLE**  
SCENARIO 1  
CONNECTION  
DETAIL

**SHEET**

DET-1

DATE

10-31-22

**SHEET WORK NOTES:** #

1. TIE INTO EXISTING SINGLE-PAIR COMMUNICATIONS CABLE. EXTEND TO NEW CELLULAR GATEWAY. FIELD COORDINATE.
2. PROVIDE REMOTE CELLULAR ANTENNA AND LOCATE INCONSPICUOUSLY ON EXTERIOR OF BUILDING SUCH THAT SUFFICIENT SIGNAL IS OBTAINED. ROUTE COAXIAL CABLE ABOVE CEILINGS OR IN RACEWAY TO GREATEST EXTENT POSSIBLE. COORDINATE IN FIELD.
3. NEW CELLULAR GATEWAY W/SIM CARD. SURFACE MOUNT TO WALL IN ACCESSIBLE LOCATION 48" AFF. RATH/JANUS# 2100-LTEGSM4-2 OR APPROVED EQUAL.
4. EXISTING ELEVATOR CAR PHONE WITH CALL ACTIVATION BUTTON, SPEAKER AND REASSURANCE LED INDICATOR.
5. 1000VA UPS. PROVIDE CONNECTION TO EXISTING 120V ELECTRICAL CIRCUIT WITHIN CONTROLLER ROOM. FIELD COORDINATE. RATH/JANUS# RP7700104 OR APPROVED EQUAL.
6. PROVIDE NEW SINGLE-PAIR COMMUNICATIONS BETWEEN EXISTING CONTROLLER AND CELLULAR GATEWAY. SIZED IN ACCORDANCE WITH MANUFACTURER RECOMMENDATIONS.

BLDG EXTERIOR WALL

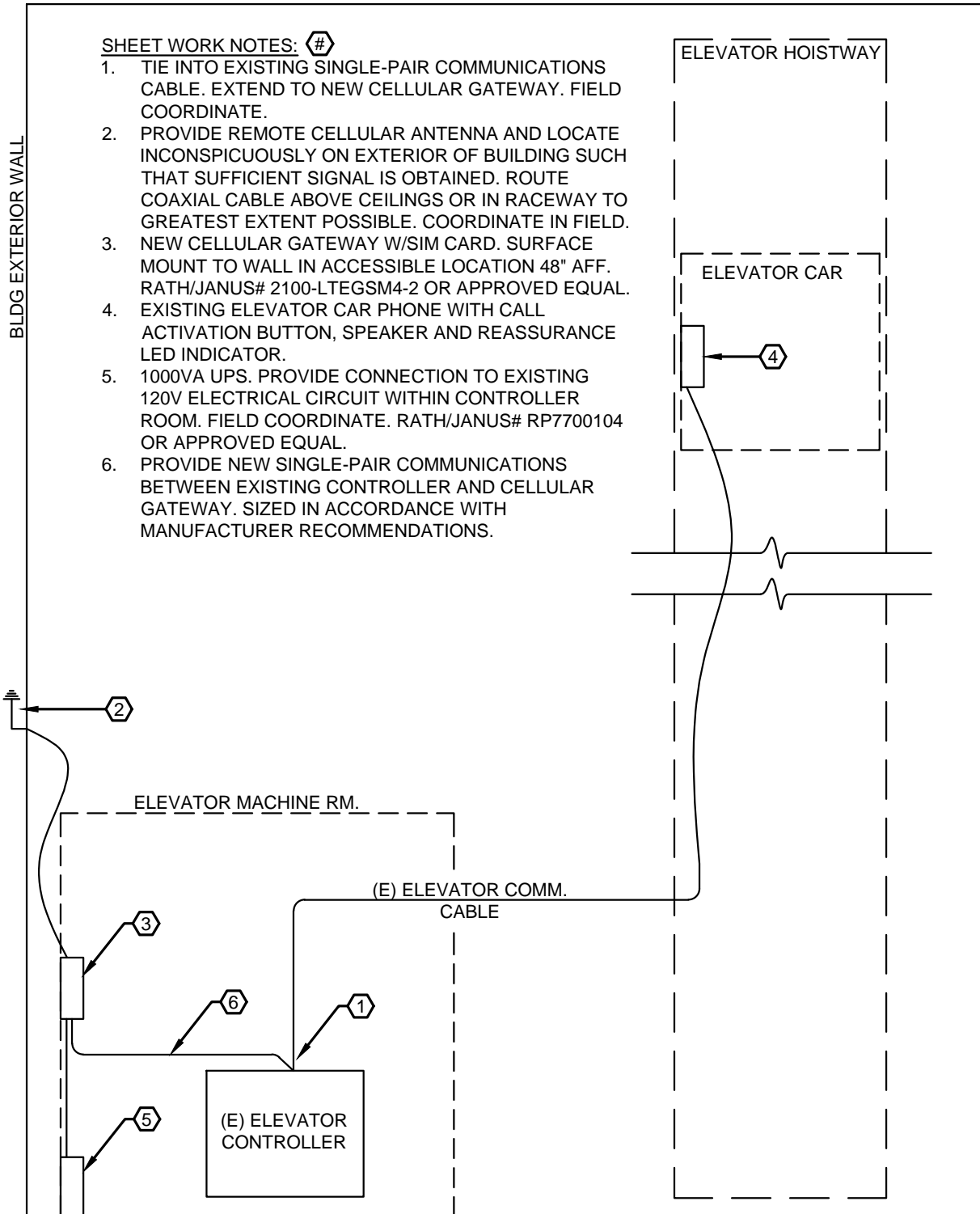

**SCENARIO 1  
ELEVATOR CONNECTION DETAIL**

1  
DET-1

N.T.S.

REV.	DESCRIPTION	DATE
△	-	-

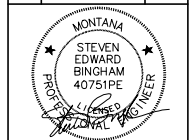

PPA#21-0104

-

Consultant#:  
MSU\_ELEVATOR

**SHEET TITLE**  
SCENARIO 2  
CONNECTION  
DETAIL

**SHEET**

DET-2

DATE

10-31-22

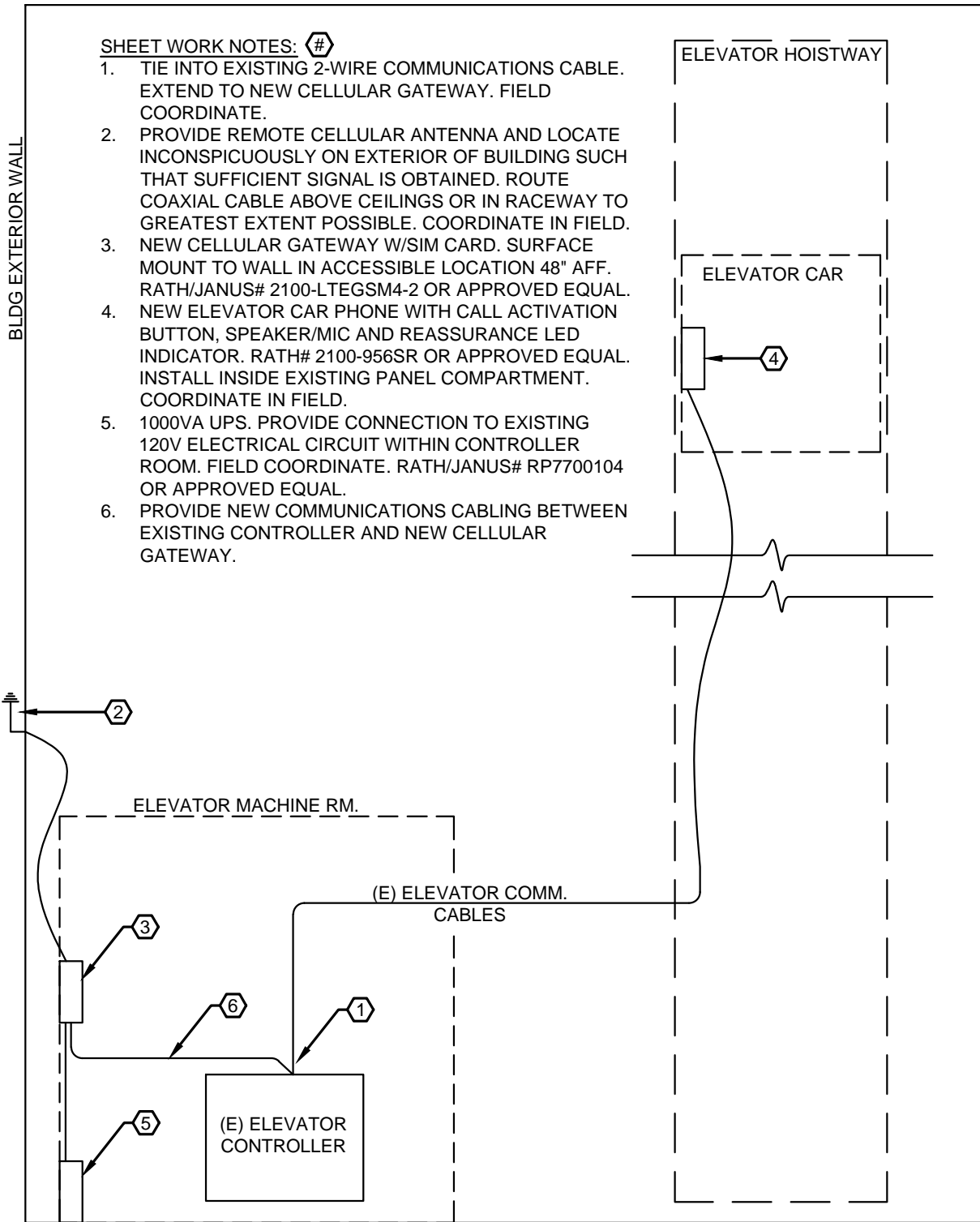

**SHEET WORK NOTES:** (#)

1. TIE INTO EXISTING 2-WIRE COMMUNICATIONS CABLE. EXTEND TO NEW CELLULAR GATEWAY. FIELD COORDINATE.
2. PROVIDE REMOTE CELLULAR ANTENNA AND LOCATE INCONSPICUOUSLY ON EXTERIOR OF BUILDING SUCH THAT SUFFICIENT SIGNAL IS OBTAINED. ROUTE COAXIAL CABLE ABOVE CEILINGS OR IN RACEWAY TO GREATEST EXTENT POSSIBLE. COORDINATE IN FIELD.
3. NEW CELLULAR GATEWAY W/SIM CARD. SURFACE MOUNT TO WALL IN ACCESSIBLE LOCATION 48" AFF. RATH/JANUS# 2100-LTEGSM4-2 OR APPROVED EQUAL.
4. NEW ELEVATOR CAR PHONE WITH CALL ACTIVATION BUTTON, SPEAKER/MIC AND REASSURANCE LED INDICATOR. RATH# 2100-956SR OR APPROVED EQUAL. INSTALL INSIDE EXISTING PANEL COMPARTMENT. COORDINATE IN FIELD.
5. 1000VA UPS. PROVIDE CONNECTION TO EXISTING 120V ELECTRICAL CIRCUIT WITHIN CONTROLLER ROOM. FIELD COORDINATE. RATH/JANUS# RP7700104 OR APPROVED EQUAL.
6. PROVIDE NEW COMMUNICATIONS CABLING BETWEEN EXISTING CONTROLLER AND NEW CELLULAR GATEWAY.

**SCENARIO 2  
ELEVATOR CONNECTION DETAIL**

1  
DET-2

N.T.S.

REV.	DESCRIPTION	DATE
△	-	-

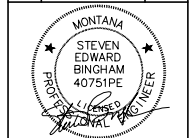

PPA#21-0104

Consultant#:  
MSU\_ELEVATOR

**SHEET TITLE**  
SCENARIO 3  
CONNECTION  
DETAIL

**SHEET**  
DET-3

**DATE**  
10-31-22

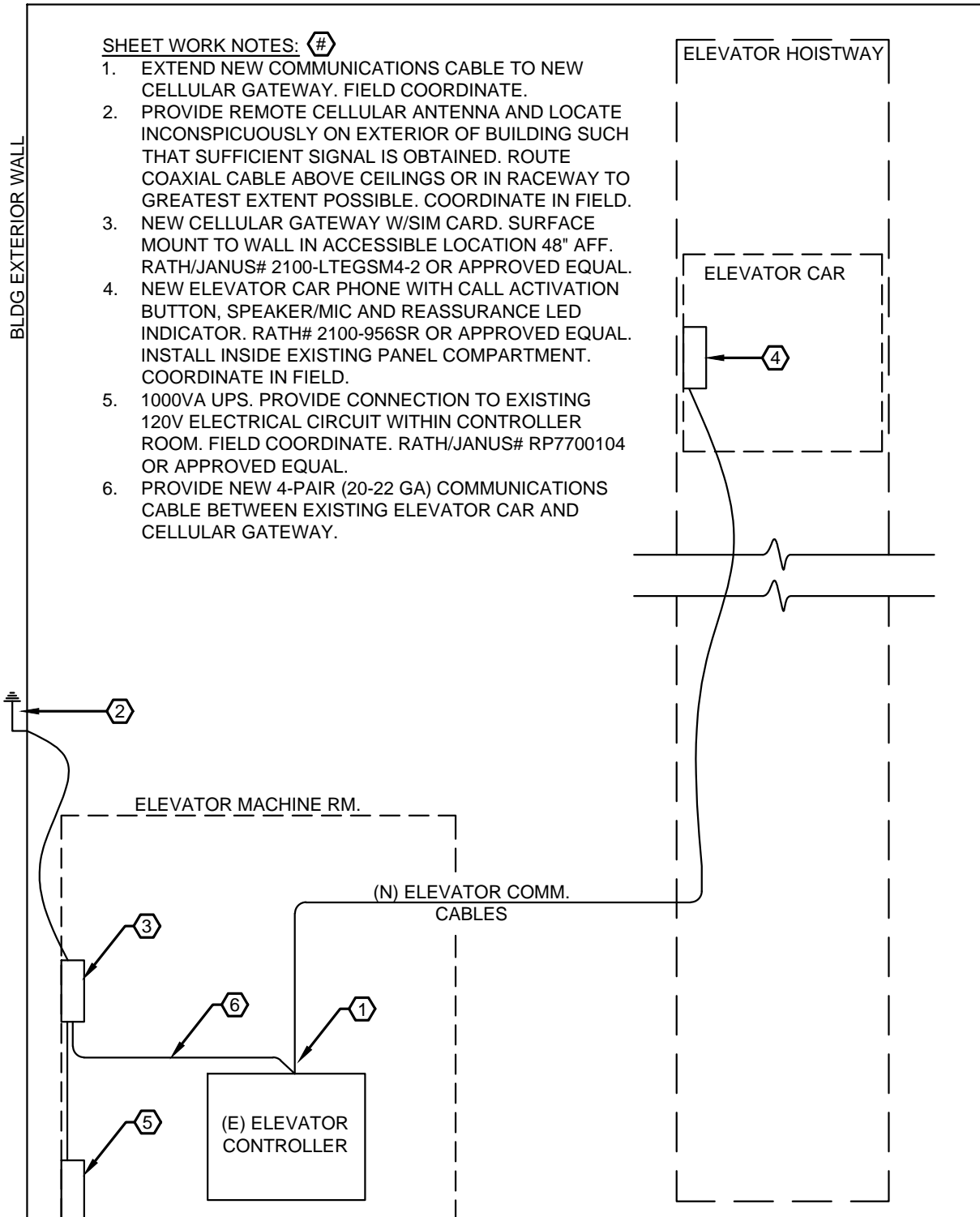

1  
DET-3

**SCENARIO 3  
ELEVATOR CONNECTION DETAIL**

N.T.S.

REV.	DESCRIPTION	DATE
△	-	-

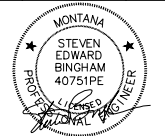

PPA#21-0104

Consultant#:  
MSU\_ELEVATOR

**SHEET TITLE**  
SCENARIO 4  
CONNECTION  
DETAIL

**SHEET**

DET-4

**DATE**  
10-31-22

BLDG EXTERIOR WALL

**SHEET WORK NOTES:** (#)

1. TIE INTO EXISTING 2-WIRE COMMUNICATIONS CABLE. EXTEND TO NEW CELLULAR GATEWAY. FIELD COORDINATE.
2. PROVIDE REMOTE CELLULAR ANTENNA AND LOCATE INCONSPICUOUSLY ON EXTERIOR OF BUILDING SUCH THAT SUFFICIENT SIGNAL IS OBTAINED. ROUTE COAXIAL CABLE ABOVE CEILINGS OR IN RACEWAY TO GREATEST EXTENT POSSIBLE. COORDINATE IN FIELD.
3. NEW CELLULAR GATEWAY W/SIM CARD. SURFACE MOUNT TO WALL IN ACCESSIBLE LOCATION 48" AFF. RATH/JANUS# 2100-LTEGSM4-2 OR APPROVED EQUAL.
4. EXISTING ELEVATOR CAR CALL STATION WITH CALL ACTIVATION BUTTON, SPEAKER AND REASSURANCE LED INDICATOR. VERIFY IN FIELD.
5. 1000VA UPS. PROVIDE CONNECTION TO EXISTING 120V ELECTRICAL CIRCUIT WITHIN CONTROLLER ROOM. FIELD COORDINATE. RATH/JANUS# RP7700104 OR APPROVED EQUAL.
6. PROVIDE NEW RS232 COMMUNICATIONS BETWEEN EXISTING CONTROLLER AND CELLULAR GATEWAY.
7. NEW MASTER STATION (UP TO 5 CALL BOXES) RATH# 2500-205B IN SURFACE MOUNT CABINET. MOUNT SO TOP OF CABINET IS 48" AFF.
8. PROVIDE NEW 4-PAIR (20-22 GA) COMMUNICATIONS CABLE TO EACH ELEVATOR CONTROLLER.

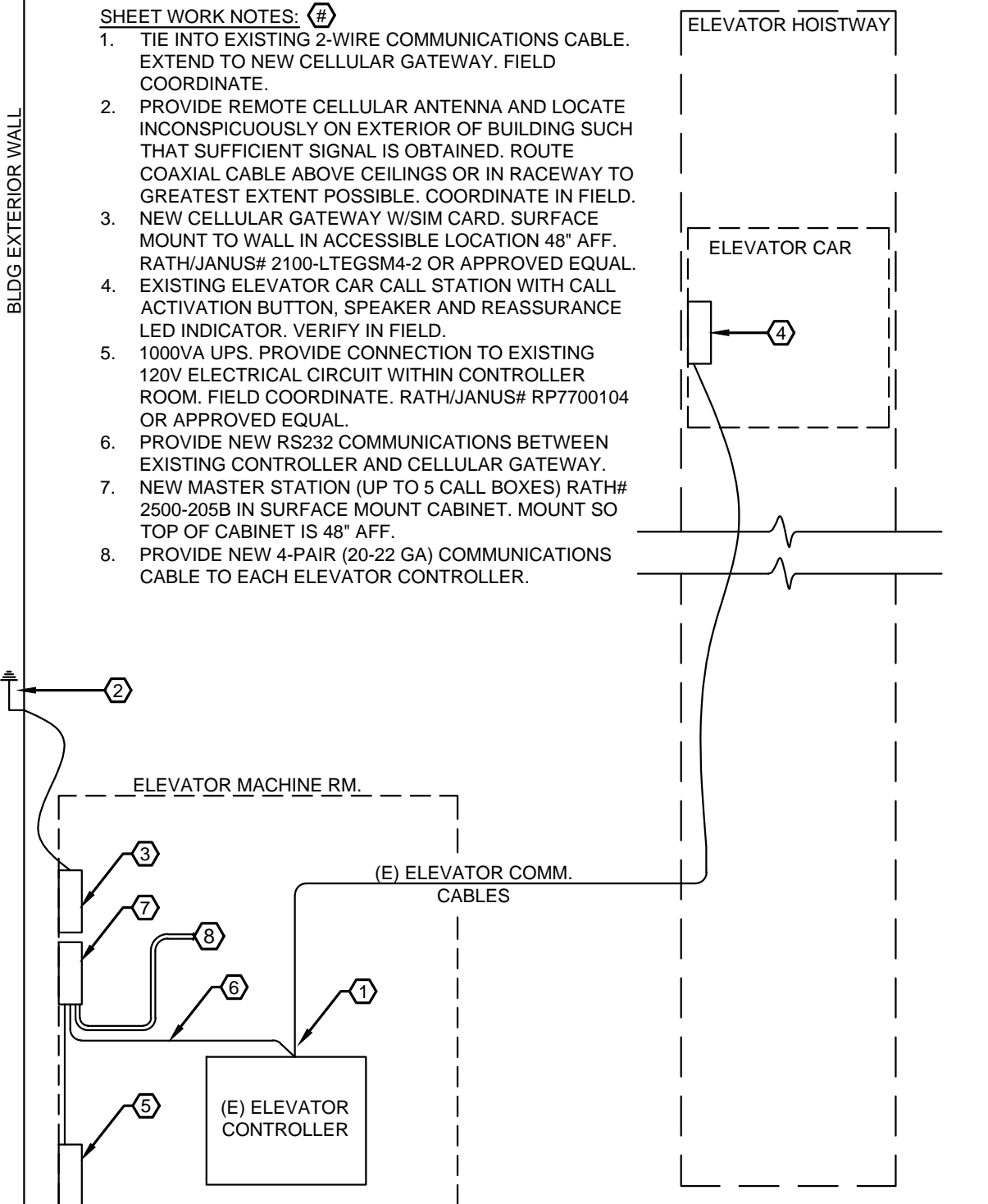

**SCENARIO 4  
ELEVATOR CONNECTION DETAIL**

1  
DET-4

N.T.S.

**SHEET WORK NOTES:** #

1. 4-PAIR, 20-22 GA TWISTED PAIRS, JACKETED.
2. COAXIAL ANTENNA CABLE PER MANUFACTURERS REQUIREMENTS.
3. 120VAC POWER TO NEAREST RECEPTACLE.
4. SYSTEM POWER CABLE PER MANUFACTURER'S REQUIREMENTS. PROVIDE CONNECTION TO NEAREST AVAILABLE 120VAC CIRCUIT OR RECEPTACLE.

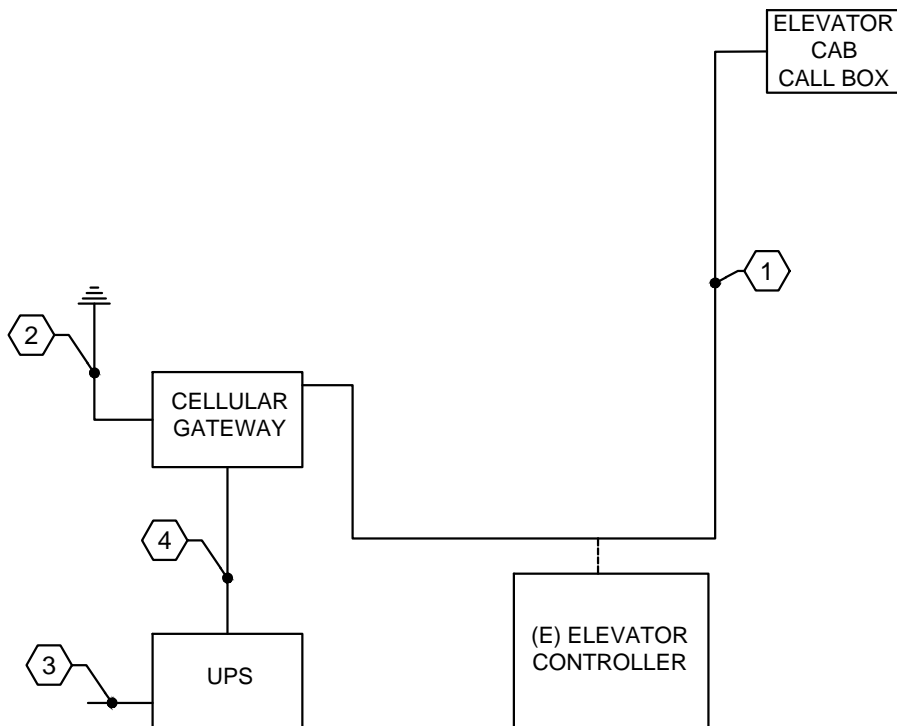

1  
DET-5

**ONE-LINE  
ELEVATOR CONNECTION DETAIL**

N.T.S.



MSU-CPDC

MONTANA STATE UNIVERSITY  
BOZEMAN, MONTANA  
PHONE: 406.994.5413  
FAX: 406.994.5665

**CAMPUS ELEVATOR  
COMMUNICATIONS  
INSTALLATION**  
MSU BOZEMAN CAMPUS



HELENA, MT  
p 406.495.9400  
f 406.495.9403

DRAWN BY: CUSHING TERRELL

REV.	DESCRIPTION	DATE
△	-	-

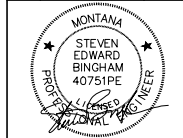

PPA#21-0104

Consultant#:  
MSU\_ELEVATOR

**SHEET TITLE**  
ONE-LINE  
CONNECTION  
DETAIL

**SHEET**  
DET-5

**DATE**  
10-31-22

**SHEET WORK NOTES:** #

1. 4-PAIR, 20-22 GA TWISTED PAIRS, JACKETED.
2. COAXIAL ANTENNA CABLE PER MANUFACTURERS REQUIREMENTS.
3. 120VAC POWER TO NEAREST RECEPTACLE.
4. SYSTEM POWER CABLE PER MANUFACTURER'S REQUIREMENTS. PROVIDE CONNECTION TO NEAREST AVAILABLE 120VAC CIRCUIT OR RECEPTACLE.
5. NEW SYSTEM MASTER STATION FOR CONSOLIDATION OF MULTIPLE CALL STATIONS.

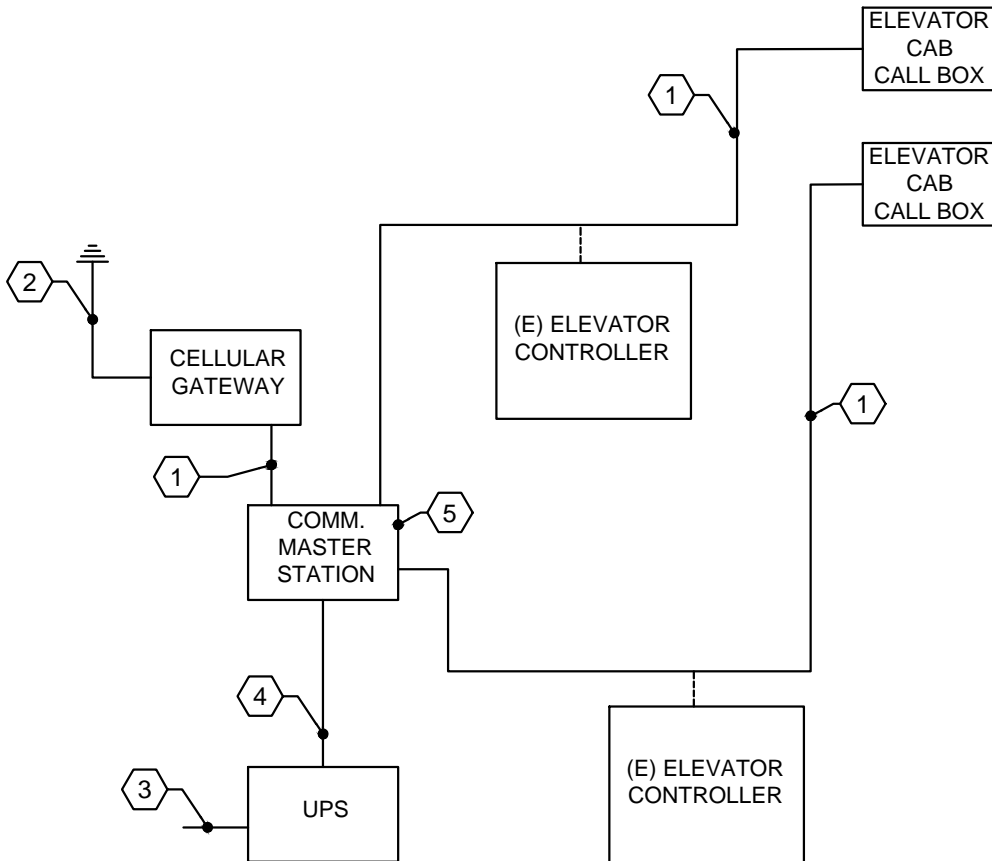

1  
DET-6

**ONE-LINE  
ELEVATOR CONNECTION DETAIL**

N.T.S.



MSU-CPDC

MONTANA STATE UNIVERSITY  
BOZEMAN, MONTANA  
PHONE: 406.994.5413  
FAX: 406.994.5665

**CAMPUS ELEVATOR  
COMMUNICATIONS  
INSTALLATION**  
MSU BOZEMAN CAMPUS



HELENA, MT  
p 406.495.9400  
f 406.495.9403

DRAWN BY: CUSHING TERRELL

REVIEWED BY:

REV.	DESCRIPTION	DATE
△	-	-



PPA#21-0104

-

Consultant#:  
MSU\_ELEVATOR

**SHEET TITLE**  
ONE-LINE  
CONNECTION  
DETAIL

**SHEET**  
DET-6

**DATE**  
10-31-22